

Zeitschrift: Bauen + Wohnen = Construction + habitation = Building + home : internationale Zeitschrift

Herausgeber: Bauen + Wohnen

Band: 21 (1967)

Heft: 7

Artikel: Werkverzeichnis = Liste de fabrication = Index

Autor: [s.n.]

DOI: <https://doi.org/10.5169/seals-332894>

Nutzungsbedingungen

Die ETH-Bibliothek ist die Anbieterin der digitalisierten Zeitschriften. Sie besitzt keine Urheberrechte an den Zeitschriften und ist nicht verantwortlich für deren Inhalte. Die Rechte liegen in der Regel bei den Herausgebern beziehungsweise den externen Rechteinhabern. [Siehe Rechtliche Hinweise.](#)

Conditions d'utilisation

L'ETH Library est le fournisseur des revues numérisées. Elle ne détient aucun droit d'auteur sur les revues et n'est pas responsable de leur contenu. En règle générale, les droits sont détenus par les éditeurs ou les détenteurs de droits externes. [Voir Informations légales.](#)

Terms of use

The ETH Library is the provider of the digitised journals. It does not own any copyrights to the journals and is not responsible for their content. The rights usually lie with the publishers or the external rights holders. [See Legal notice.](#)

Download PDF: 02.02.2025

ETH-Bibliothek Zürich, E-Periodica, <https://www.e-periodica.ch>

Werkverzeichnis

Liste de fabrication
Index



1



2

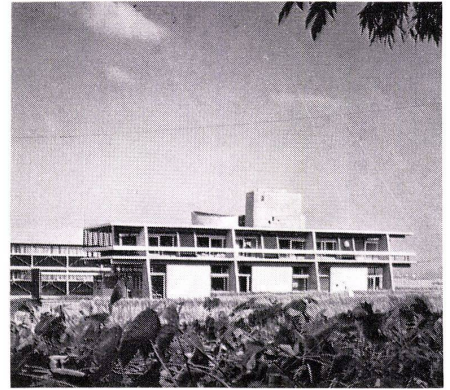

3

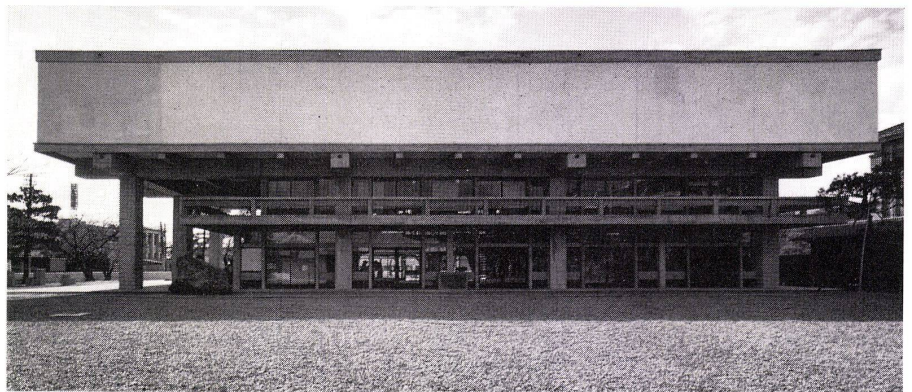

4

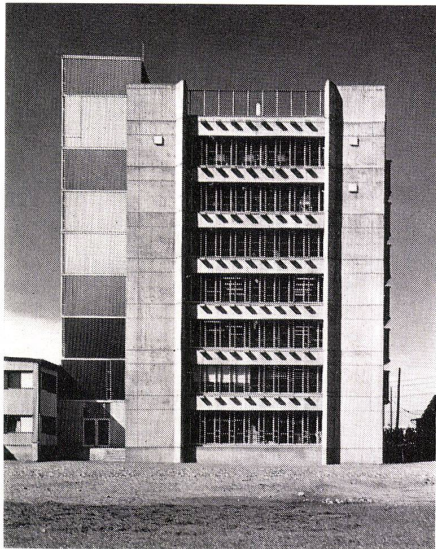

5

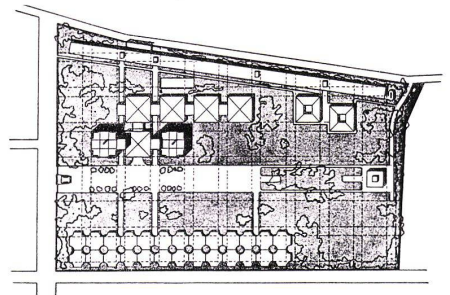

7

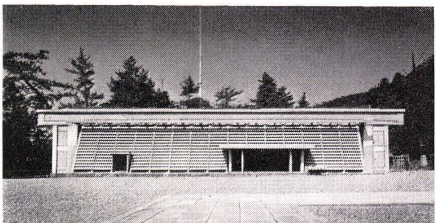

6

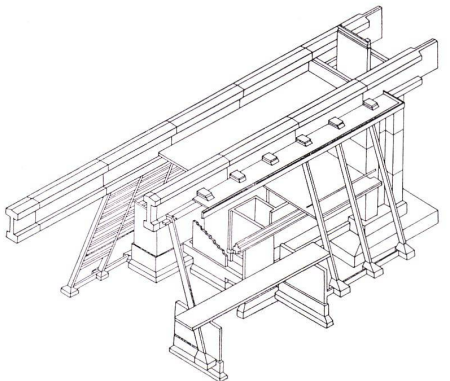

8

1
Apartmenthaus für die Angestellten der Bridgestone Tine Co. Ltd.
Maison d'appartements pour les employés de Bridgestone Tine Co. Ltd.
Apartment house for the employees of the Bridgestone Tine Co. Ltd.

2
Kikutakes eigenes Wohnhaus.
Kikutake, sa propre maison d'habitation.
Kikutake's own home.

3
Nervenklinik.
Clinique psychiatrique.
Neurological clinic.

4
Shimane Prefecture Museum.
Musée de la préfecture Shimane.
Shimane Prefecture Museum.

5, 6
Fabrik der Seconic optical instruments Mtg. Co.
Fabrique de la Seconic optical instruments Mtg. Co.
Factory of the Seconic Optical Instruments Mtg. Co.

7, 8
Verwaltungsgebäude für den großen Schrein von Izumo.
Bâtiment administratif pour le gros écrivain de Izumo.
Office building for the great Shrine of Izumo.

9, 10
 Rathaus Tatebayashi.
 Hôtel de Ville de Tatebayashi.
 Tatebayashi Town Hall.

10
 Erweiterung:
 Agrandissement.
 Extension.

11, 12
 Wettbewerb für die internationale Kongreßhalle in
 Kyoto.
 Concours pour le Palais international des Congrès
 à Kyoto.
 Competition for the International Convention Hall in
 Kyoto.

13, 14
 Morioka Grand Hotel.
 Grand Hôtel de Morioka.
 Morioka Grand Hotel.

15
 Apartmenthaus.
 Maison d'appartements.
 Apartment house.

16
 Raststätte.
 Station-restaurant.
 Rest area.



9

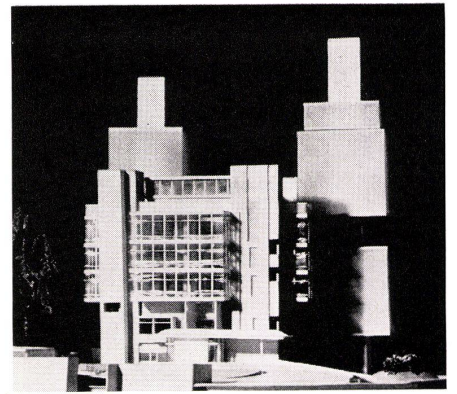

10

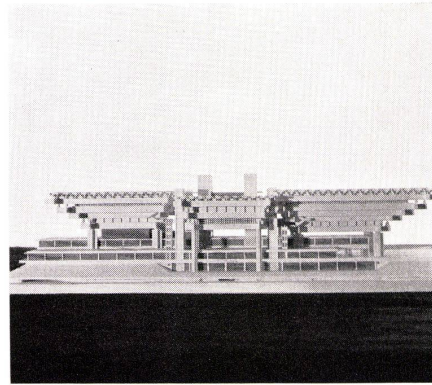

11

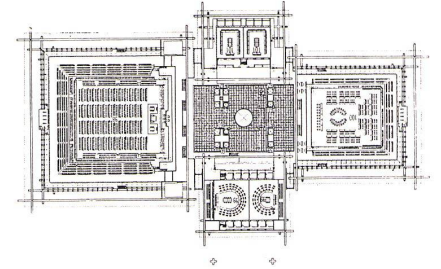

12

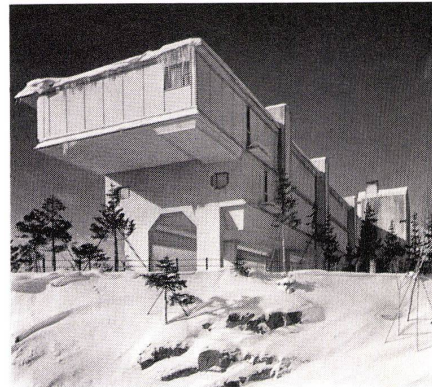

13

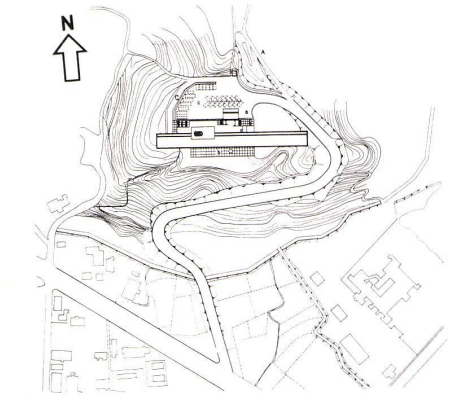

14

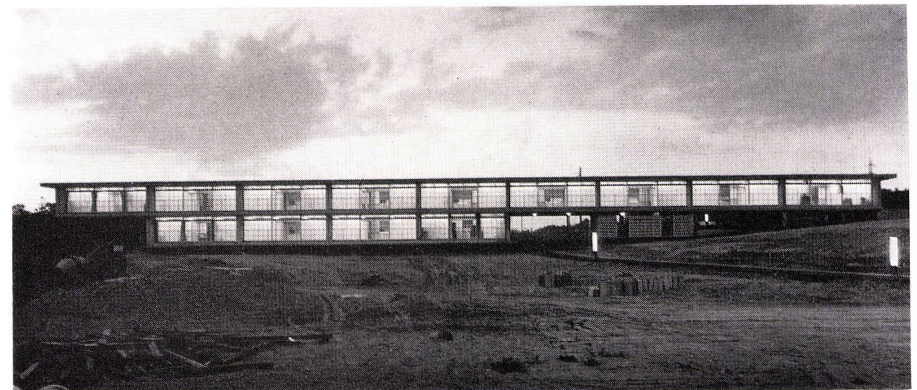

15

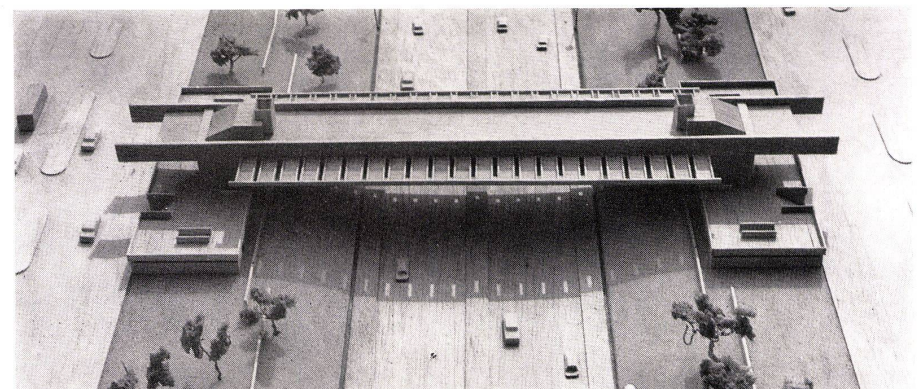

16

17, 18
 Tokoem Hotel.
 Hôtel Tokoem.
 Tokoem Hotel.

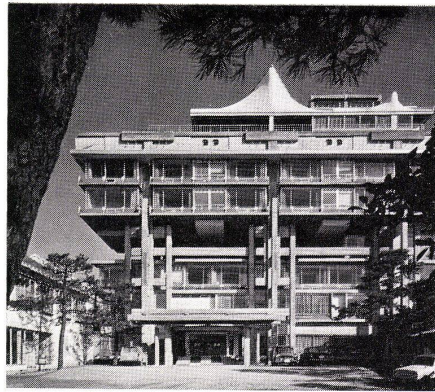

17

19
 Kanagawa Pref.
 Préfecture de Kanagawa.
 Kanagawa Pref.

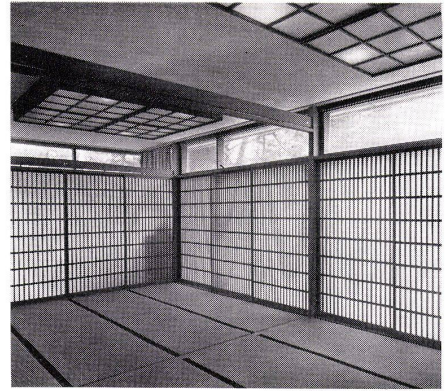

18

20
 Urnenhaus.
 Columbarium.



19

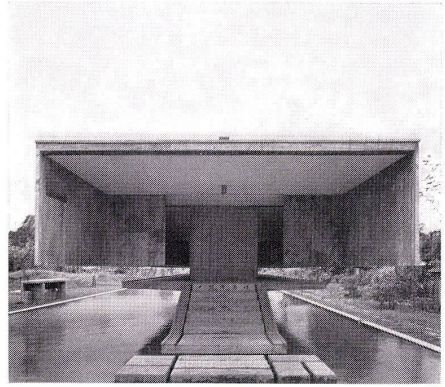

20

21
 »Gewerkschaftshaus« für staatliche Angestellte.
 «Maison du syndicat» des employés d'état.
 "Trade Union House" for government employees.

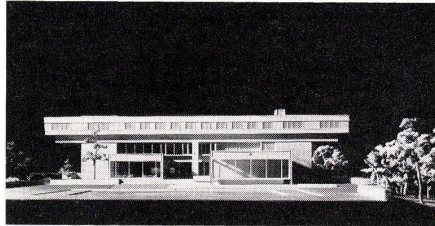

21

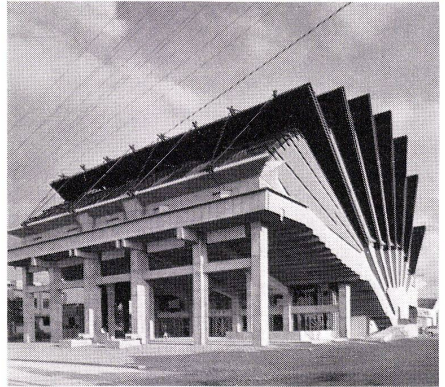

22

22, 24
 Stadthalle.
 Salle municipale.
 City Hall.



23

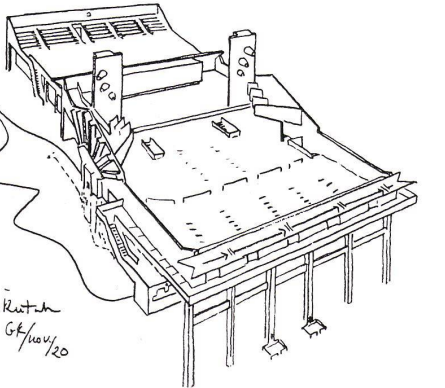

24

23
 Pazifik Hotel.
 Hôtel Pacific.
 Pacific Hotel.

25
 Sado Grand Hotel.
 Grand Hôtel Sado.
 Sado Grand Hotel.

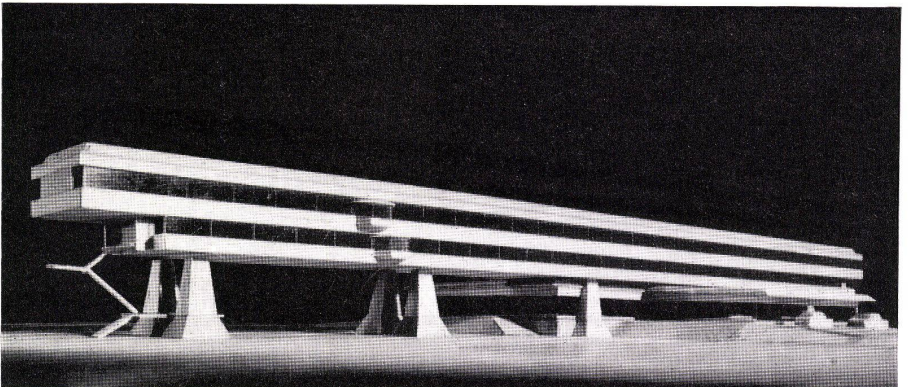

25