

Distribution frame connector system 83 (VS 83)

Autor(en): **Steiger, Hans**

Objektyp: **Article**

Zeitschrift: **Technische Mitteilungen / Schweizerische Post-, Telefon- und Telegrafienbetriebe = Bulletin technique / Entreprise des postes, téléphones et télégraphes suisses = Bollettino tecnico / Azienda delle poste, dei telefoni e dei telegrafi svizzeri**

Band (Jahr): **63 (1985)**

Heft 12

PDF erstellt am: **22.07.2024**

Persistenter Link: <https://doi.org/10.5169/seals-875418>

Nutzungsbedingungen

Die ETH-Bibliothek ist Anbieterin der digitalisierten Zeitschriften. Sie besitzt keine Urheberrechte an den Inhalten der Zeitschriften. Die Rechte liegen in der Regel bei den Herausgebern.

Die auf der Plattform e-periodica veröffentlichten Dokumente stehen für nicht-kommerzielle Zwecke in Lehre und Forschung sowie für die private Nutzung frei zur Verfügung. Einzelne Dateien oder Ausdrucke aus diesem Angebot können zusammen mit diesen Nutzungsbedingungen und den korrekten Herkunftsbezeichnungen weitergegeben werden.

Das Veröffentlichen von Bildern in Print- und Online-Publikationen ist nur mit vorheriger Genehmigung der Rechteinhaber erlaubt. Die systematische Speicherung von Teilen des elektronischen Angebots auf anderen Servern bedarf ebenfalls des schriftlichen Einverständnisses der Rechteinhaber.

Haftungsausschluss

Alle Angaben erfolgen ohne Gewähr für Vollständigkeit oder Richtigkeit. Es wird keine Haftung übernommen für Schäden durch die Verwendung von Informationen aus diesem Online-Angebot oder durch das Fehlen von Informationen. Dies gilt auch für Inhalte Dritter, die über dieses Angebot zugänglich sind.

Distribution frame connector system 83 (VS 83)

Hans STEIGER, Berne

1 Introduction

11 How microelectronics affect connector technology

Besides asserting itself with a conspicuously wider range of design features, the use of highly integrated solid state components in modern telecommunications systems makes itself felt primarily by the reduced floor space required by various system units. With the introduction of VLSI technology (Very Large Scale Integration), this trend is likely to continue into the future – although perhaps at a somewhat slower pace.

In simplified terms, a telecommunications system can be divided into the three following basic elements: *terminal equipment, transmission and switching* (Fig. 1). Whereas the first and the last area have been quite strongly affected by the influence of microelectronics, the transmission sector – except for its line termination equipment – has not changed to any appreciable extent.

Even today solder-type terminal blocks are still widely used in various distribution systems (such as in main distribution frames (MDF), intermediate distribution frames (IDF) and exchange distribution frames for building lead-in cables and similar applications).

The problems caused by clinging to traditional connector designs made themselves clearly felt on certain occasions such as, for example, during the introduction of fully electronic PABXs.

Whereas the share of installation space required for the main distribution frame of a traditionally designed installation amounts to a mere 15%, it rises to almost 60% as soon as compact modern electronic exchanges are used (Fig. 2a and 2b).

Present building and land prices demand the optimal utilization of any given floor space. This gives rise to a wide-spread desire to bring the share of the installation space required by a main distribution frame back to the same percentage value as in traditional equipment.

12 Soldered connectors and modern equipment development trends

The requirement to reduced installation space is always assigned high priority during the development of new connector systems. However, the prospects of extend-

ing miniaturization to the connector sector are severely limited, since the wiring of the connections is still largely done by hand, and it is likely to remain so during the foreseeable future. If it is assumed that the ease of connector handling should correspond to previous standards, then modern connector systems can reduce the installation space required by an estimated 50%.

Again in terms of a modern electronic exchange of medium size, the share of the floor space required for the installation of a main distribution frame is thus reduced to about 30% (Fig. 2c).

In addition to the large amount of installation space required, costly and time-consuming soldering techniques must be identified as additional disadvantages of traditional distribution equipment.

However, these two main drawbacks of the solder-type connector system must be viewed in the light of its numerous advantages. These must be given due consideration during the development of a new system, mainly because a substantial part of the distribution equipment is used for PABXs which are privately-installed and maintained. In this particular area the new connector system must compete directly with the traditional type and, as experience has shown, will only be successful if its superior features are not offset by other disadvantages. The principal advantages offered by the solder-type connector system are shown in Figure 3.

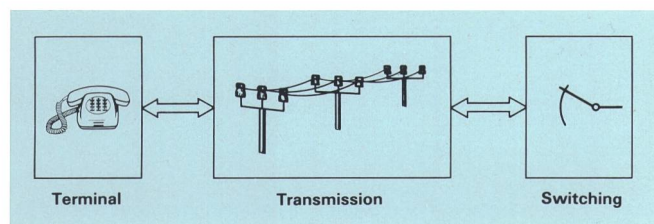

Fig. 1
Basic elements of a telecommunications system

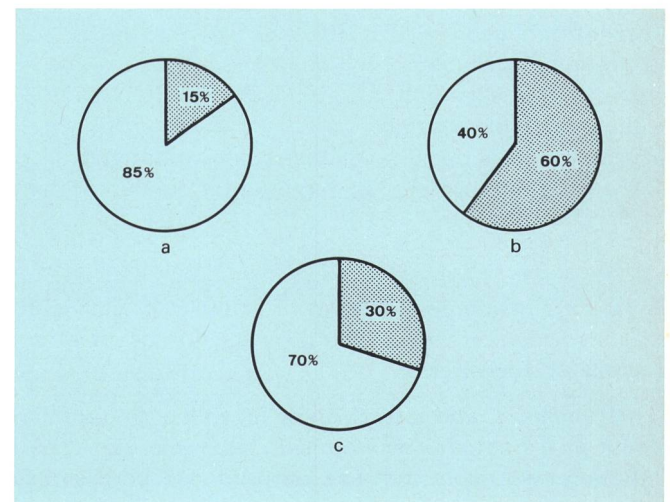

Fig. 2
Floor space required by the main distribution frame of a medium-sized PABX system

- a) Electromechanical PABX
- Traditional main distribution frame (MDF)
- b) Electronic PABX
- Traditional MDF
- c) Electronic PABX
- Modern MDF

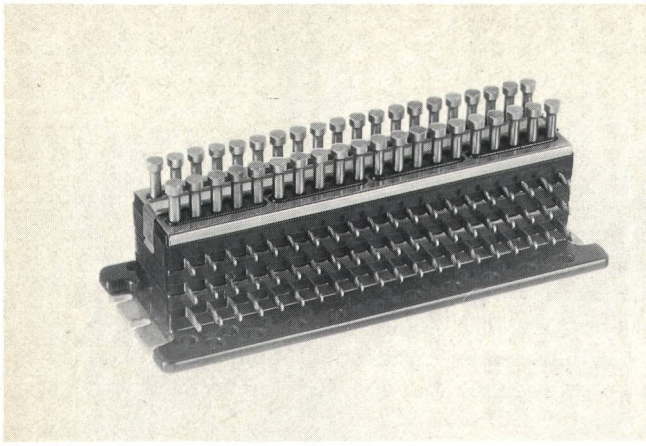

Fig. 3
Advantages of the traditional soldered connection

- Cost-effective
- Reliable
- Robust design
- High modularity
- Simple to manufacture
- Ease of handling
- Versatile application
- Wide range of wire thicknesses

After extensive evaluations of commercially available products had produced no satisfactory results, the Swiss PTT decided to prepare their own design concept that would comply with the following requirements:

- low volume
- solderless connections
- integral overvoltage protection
- flat conductor cabling (ribbon cables)
- interruption-free testing and measurement of connections
- very easy to use
- cost effective
- strong and reliable
- application versatility
- highly modular design
- wide range of designation and labelling options
- minimum of special tools required for connector handling

It took a considerable amount of effort to comply with all these requirements without having to accept other, undesired side effects.

In particular, it is difficult to come up with a product that could also compete economically with traditional distribution equipment that can be produced both simply and cheaply.

Thanks to the use of ultra-modern manufacturing techniques it has nevertheless been possible with the «Connector System 83» (VS 83) to meet the previously mentioned requirements and to match the cost-effectiveness of the solder-type system. This is based on the premise that in the price comparison all important factors, such as the price of the terminal blocks and the rack construction as well as installation time and floor space requirements, have all been taken into account. If the many additional application options of the new system are included in the price comparison, the new sys-

tem is superior to the traditional one, even in economic terms.

Reichle and De Massari AG in Wetzikon were entrusted with the manufacture of the VS 83. This company possesses valuable experience in modern connector technology and is particularly well-known for the development of new types of distribution equipment. The Swiss PTT have applied for patents to protect the VS 83 from being copied at home and abroad.

It is intended to have several Swiss communications engineering firms participate in manufacture and distribution activities at some later time.

13 Connector technology

The selection of the basic connector technology must always precede the development of a new connector system, since both design and physical construction are decisively affected thereby.

The *insulation displacement connector* (IDC) – which originally became known in use with flat conductor cable technology – is nowadays firmly entrenched as a connector for cable cores and wires in modern distribution frames used for communications systems. In this connector technology, the pre-sorted wires are pressed, without any prior preparation, into a V-slot contact element using a special tool and then cut off.

A gas-tight contact is required between the wire and the insulation displacing contact to ensure the formation of a firm connection. On older systems, in particular, this requirement is met by the use of solid contacts with a sprung slot. In this case, the substantial clamping forces greatly reduce the need for any special protection of the contact areas against mechanical stress. Figure 4 shows the various working phases of an insulation displacement connector.

The substantial increase in raw material costs over the past years has considerably raised the prices of products containing such solid contacts. For the majority of new designs, therefore, material and space-saving contacts with elastically deformable or rigid V-slot designs are used. Since this contact design is much more vulnerable to mechanical stress, it is essential that the wires be relieved of mechanical tension by fixing them in ribbed plastic clamps.

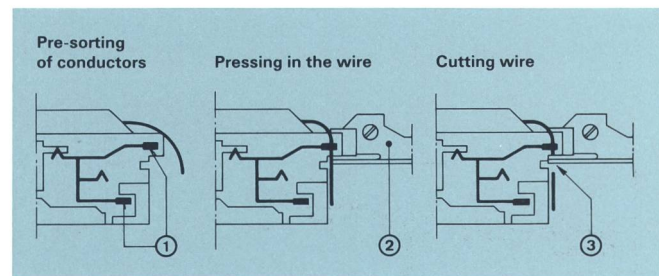

Fig. 4
The working phases of the insulation displacement connector (IDC)
① Insulation displacing contacts
② Pressing tool
③ Wire cutter

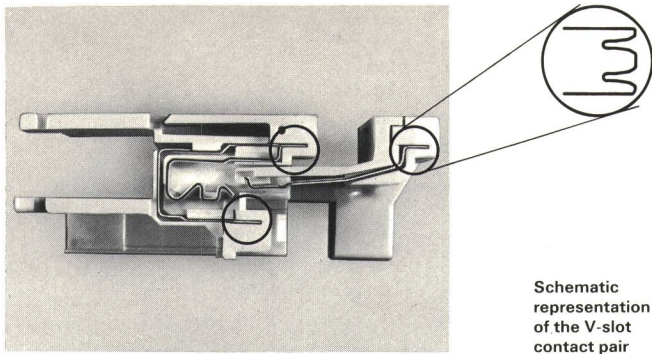

Fig. 5
Pair of V-slot contacts of the VS 83 connector system

The VS 83 uses *contact pairs* with rigid or quasi-rigid V-slots. They are quite similar in design to the contacts that Reichle and De Massari have been using successfully in their plug-type jumpered distribution frames for some years (Fig. 5).

The quality and reliability of an insulation displacement connector are primarily determined by the properties of the actual «V-slot contact» as well as by the «contact protection». The VS 83 technical specification actually covers the *contact element* which includes both these parts. A number of important technical data on the contact element are listed below:

- tinned/untinned copper wire with plastic insulation
- conductor diameter range 0.4 to 0.6 mm
- diameter range including insulation, cable side 0.7 to 1.2 mm
- diameter range including insulation, jumpering side 0.9 to 1.4 mm
- width of V-slot 0.28 mm
- number of connections < 200
- contact protection through embedding of contacts in plastic ribbed supports
- contact quality in accordance with Swiss PTT specification 839.76 VI/80

On the cable side the stated outside diameter range from 0.7 to 1.2 mm covers practically all popular cable types currently used in exchange or subscriber environments.

However, on the jumpering side, the usual wires or jumper connections often exceed the defined 0.9 to 1.4 mm range. The VS 83 system with its substantially higher connector density demands a correspondingly higher packing density of the wires or jumpers in order that the space savings are not partially offset by larger distances between the bays.

The introduction of the VS 83 connector system, therefore, imposes the need to replace some existing wire types with new ones that will satisfy the changed requirements.

2 System description

21 Introduction

The development of a connector system designed to comply with the large number of new stipulations in-

volves considerable expenditure. If for the time being foreign markets are not taken into account, these substantial development costs must be viewed in the light of the low domestic sales potential estimated at approximately 6 million connection points per annum.

In order to mass produce such a system under these unfavourable conditions and still achieve a cost-competitive product, the following prerequisites must be met:

- the application range must cover the entire telecommunications sector
- design must be based on a small number of discrete parts
- modular design must permit adaptation to the requirements of the various areas of application

These prerequisites were strictly adhered to during the development of the VS 83 system with the decisive result that this system, in spite of its much higher performance characteristics, is able not only to hold its own against the solder-type systems but can also compete costwise with systems produced abroad.

The third design requirement – modular versatility – actually led to the VS 83 master design concept which permits the implementation of various functional units by simply adding some additional elements to one standard base unit.

As was previously the case, there must also in future be at least two functional units available, namely connecting terminal blocks and isolating terminal blocks. Whereas the connecting terminal blocks are merely used for connecting wires and cable cores, some additional functions are required of the isolating terminal blocks, such as the disconnection, through-connection and measurement of single and multiple connections.

The conventional isolating terminal block generally incorporates normally-open contacts which can be actuated by inserting or removing pins or plugs. In the VS 83 system, however, *normally-closed contacts* that establish through connections in the rest position serve the same purpose.

In comparison with normally-open contacts, normally-closed contacts show certain important advantages, mainly on the operating side, such as:

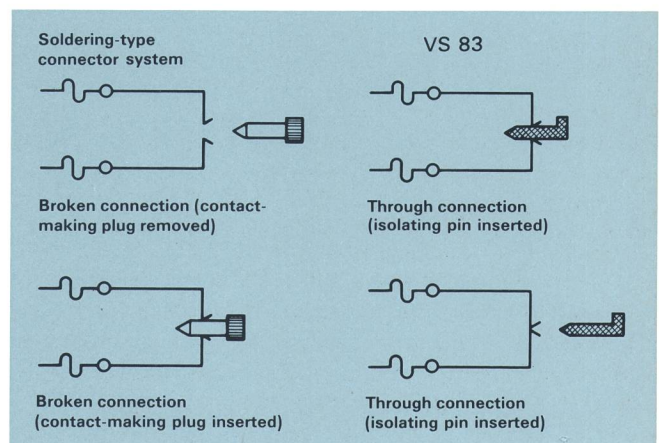
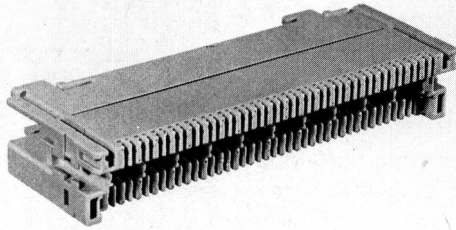

Fig. 6
Isolating terminal block, basic diagram



Schematic representation

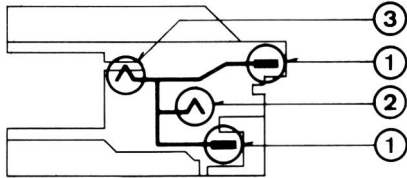

Fig. 7
Construction and schematic diagram of the connecting element
 ① Insulation displacing contact
 ② Isolating contact
 ③ Printed circuit board contact

- only one contact transition per through connection
- interruption-free measurement and testing of connections
- through-connection and isolation of all connections on the terminal block in a single operation.

Figure 6 shows the basic operating principle of the old and new isolating terminal block.

Telecommunications systems use connections with a varying number of conductors. The number of connection points on the connecting and isolating terminal blocks must always be a multiple of these conductors to avoid space-wasting blank contacts. The VS 83 offers two versions of these terminal blocks, one with 20 and one with 24 contacts, and therefore fulfills this particular requirement for almost every known type of connection.

22 Connecting element – connecting terminal block

Functionally, VS 83 corresponds to a multi-pin connector system with a female and a male connector. These are known as the *connecting* or *isolating element* respectively. The connecting element is the most important and also the most costly system component; it serves as a basis for assembling the various functional units.

Besides various basic design provisions for adding further system elements, the connecting element incorporates a number of contact-making and interfacing elements, such as:

- two rows, each with 20 or 24 pairs of insulation displacing contacts for connecting cable cores and jumpers
- 20 or 24 isolating contacts for measurement plugs and isolating elements
- 20 or 24 printed circuit contacts to connect over-voltage arresters, ribbon cable connector and various printed circuit cards

As shown in Figure 7, the insulation displacing connections, the isolating contact and the printed circuit contact are electrically interconnected.

The connecting element can be slotted onto two parallel mounting rails by means of a screwless snap-lock and then secured or released using a simple sliding motion. No tools are required for these operations.

Adding pluggable accessories to the connecting element, such as a conductor-guide, cable conductor covers and designation strips, will transform it into a compact and low-cost connecting terminal block (Fig. 8). The small dimensions, and, above all, an installation depth of only 48 mm, greatly facilitate installation in existing chassis or racks.

The connecting terminal blocks can be installed on the mounting rail as individual elements or lined up as continuous arrays. This permits an entire range of distribution equipment to be covered: from small units having only a few connections (such as the intermediate distribution frames on subscriber installations) up to large, high-density distribution systems of any desired capacity.

23 Isolating element – isolating terminal block

The isolating element (male half) contains a row of 20 or 24 insulation displacement connections and the same number of isolating contacts. It can be partially inserted

Construction

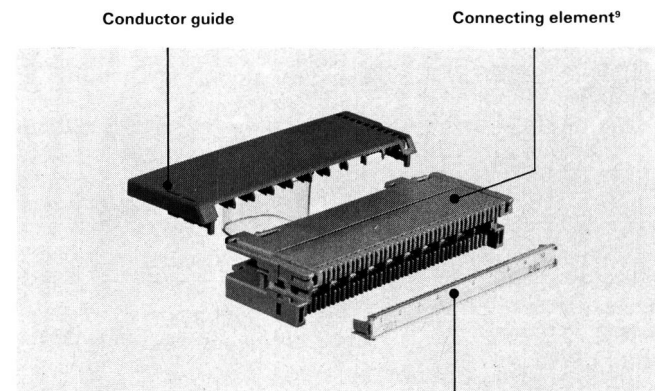

Dimensions

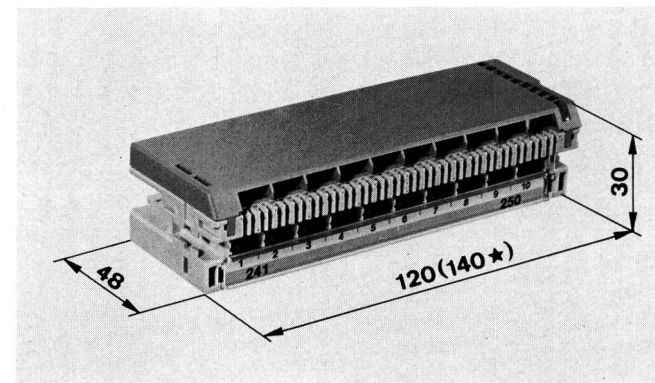

★ 24 pin

Fig. 8
VS 83 connecting terminal block

Construction

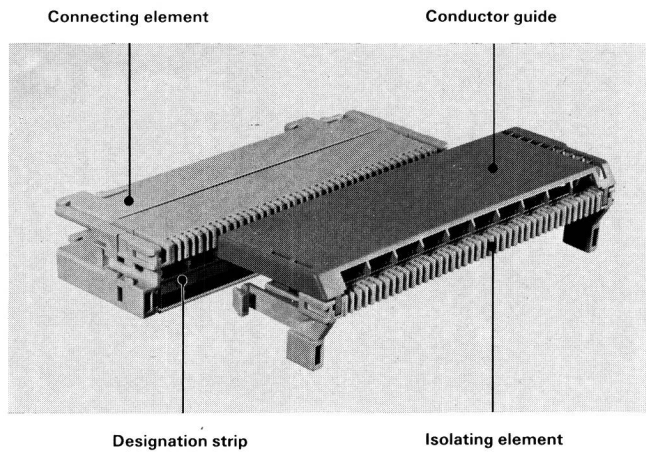

Principle of operation

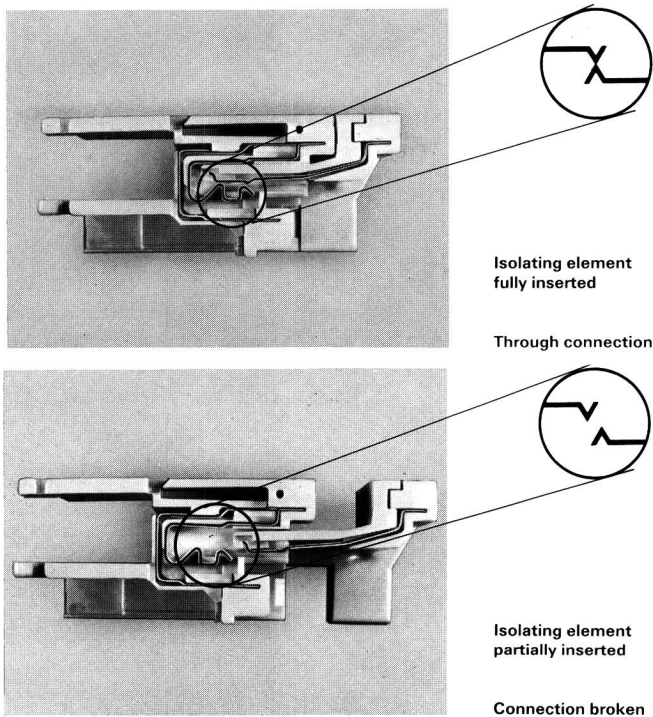

Fig. 9 Construction and principle of operation of the isolating terminal block

into the connecting element in an intermediate catch position, or fully inserted.

In the intermediate position, the isolating (disconnecting) contacts of the connecting and isolating elements are still open. They are closed only when the isolating element is fully inserted, thus through-connecting the cable terminations and the jumper connections.

When equipped with a conductor-guide plate, the connecting and isolating elements become an isolating terminal block with integral normally-closed contacts, as shown in *Figure 9*.

Being based on the «plug connector» principle, the VS 83 system features the versatile operating modes associated with such a system. It thus permits the making or breaking of all connections of the isolating terminal block simultaneously with a simple sliding motion of the

isolating element. Above all, this feature represents a considerable simplification of exchange switchover operations together with a reduction in switchover times.

Connecting a 10 or 12-pair cable to the isolating element will cause it to function as a 20 or 24-pin measurement and test connector. A cover is available to protect the cable. It is plugged onto the isolating element in place of a conductor-guide (*Fig. 10*). This opens up an entire range of new applications which previously could only be implemented on expensive and complex installations. For instance, it is now simple to connect auxiliary devices – such as traffic measuring devices, speech synthesisers, etc. – to the switching equipment.

24 Overvoltage protection

A connector system is frequently used as an interface device between the public communications network and some privately owned (or PTT owned) electronic equipment. Though such installations possess a certain level of overvoltage protection, some voltage transients greatly in excess of the surge handling capabilities of such circuits may still appear in any telecommunications network.

Overvoltage protection devices must always be installed in the immediate vicinity of building lead-in cables to prevent any critical voltage or current surges from being transmitted to the communications equipment via the internal wiring.

Lead-in cables are frequently terminated on isolating terminal blocks of exchange or main distribution frames. Any new connecting or isolating terminal blocks must therefore have specific design provisions to accept overvoltage protection devices such as gas discharge-type arresters, varistors and similar devices.

The VS 83 features special *overvoltage protection cassettes* which can be inserted in the connecting element on the side or from the rear. They provide overvoltage protection to an individual connection or to all connections on the connecting or isolating terminal block (*Fig. 11*).

25 Accessories

The VS 83 connector system has been designed to be applied in a wide range of applications: in main distribution frames for public exchange and PABX systems, in telex and Telepac exchanges, down to intermediate distribution frames for private branch exchanges (PBX). This implies that it will be handled by personnel with a wide variety of qualifications and skills. Simple handling which can be learned without attending extensive, and often expensive, training courses are therefore vitally important.

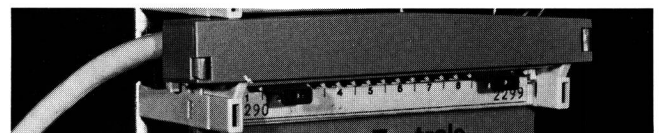

Fig. 10 20 or 24-pin measurement and test connector

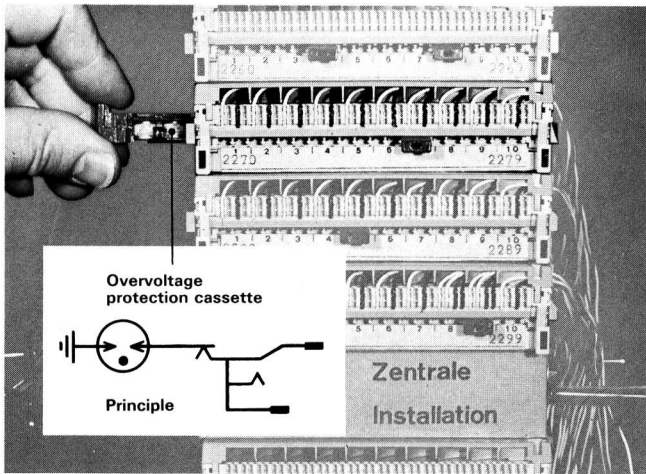

Fig. 11
Overvoltage protection cassette

The VS 83 system can be adapted to a variety of application requirements thanks to a complete set of modular accessories. Its design inherently assures simple and error-free operation.

Connection identification and labelling procedures are greatly facilitated by an ample availability of designation accessories. The connections are thus easy to identify avoiding erroneous handling (Fig. 12).

This feature acquires particular importance in view of the steady increase of special circuitry in modern communications systems. Special protection of particularly sensitive connections (such as those used in data links) is not necessary since all current-carrying parts are totally enclosed by plastic material.

A wide assortment of measurement accessories permits monitoring and test appliances to be connected in a series-loop or in parallel in an interruption-free manner (Fig. 13). Since the same test connector is used for both the connecting and isolating terminal blocks, the number of plug types is thus reduced and also plug-connected transfer can be implemented in a simple manner.

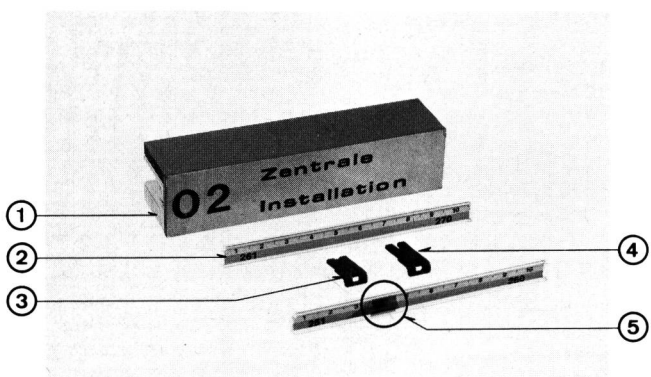
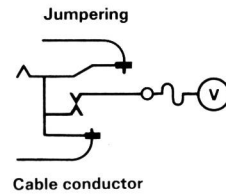

Fig. 12
Labelling and designation accessories

- ① Pluggable designation field for the designation of terminal blocks
- ② Labelling strip for designating individual connections
- ③ 2 or 3-pin markers of various colours for designating the connections and to protect them against non-authorized access
- ④ Isolating plugs, 2 or 3-pin, for breaking individual connections
- ⑤ Transparent designation plates of various colours for marking individual connections without hampering the measurement and test isolating contact

Connecting terminal block



Cord, both ends fitted with 2 or 3-pin test and plugs for pluggable jumpering connections

Isolating terminal block

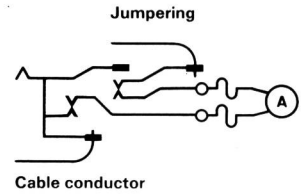

2 or 3-pin test and measurement cord, one end with R+M adapter jumpering connector

Fig. 13
Basic measuring process and accessories

Besides permitting the protection of the connections with suitable overvoltage arresters, the printed circuit contacts associated with the connecting and isolating terminal blocks also open up a great number of new possibilities for previously unknown applications.

System wiring of modern electronic equipment is frequently implemented with backpanel printed circuit boards which are interconnected via plug-connected ribbon cables. The backpanels should always be connected to the PABX systems as directly as possible and not detoured across intermediate distribution frames, in order to keep contact transitions to a minimum. This can be optimally accomplished when the ribbon cables are terminated directly on the connecting or isolating terminal blocks of the main distribution frame. Traditional distribution frame equipment is generally not suitable for the connection of such cables, and hence, this connection approach is used only in certain exceptional cases.

A simple printed circuit which can be inserted in the connecting or isolating terminal block in place of the overvoltage protection cassette can be used on the VS 83 to achieve a ribbon cable connection in a remarkably time-saving manner (Fig. 14).

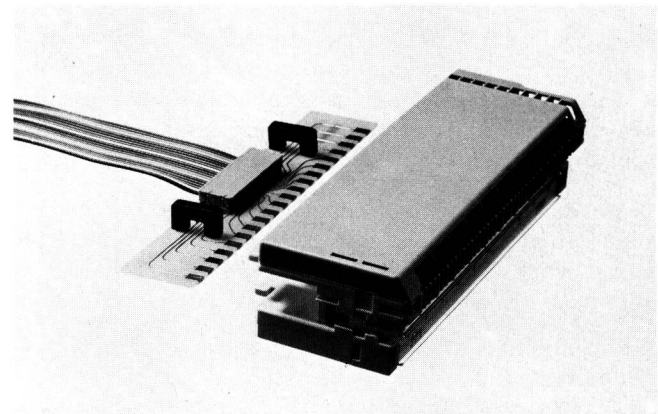

Fig. 14
Connection of ribbon cable

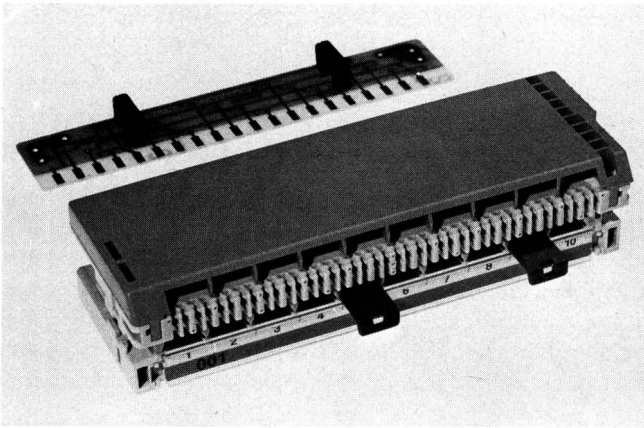

Fig. 15
Printed circuit multiple

The connection between the cable side and the jumper connection side can be made or broken simply by inserting or removing the printed circuit connector, since the ribbon cable is always easily accessible. The isolating terminal block can therefore in many cases be replaced by the lower-priced connecting terminal block.

As a further possible application for printed circuit contacts, the connecting or isolating terminal blocks may also be equipped with any required active or passive circuitry. Distribution frames, for example, are equipped with multiple connections for earth, ringing signal, power supply and other connections. On the VS 83 system, the commonly used circuit patterns can be produced by removing the appropriate conductor paths (Fig. 15).

26 Wiring tools and handling aids

During the development phase great care was taken to ensure that VS 83 needs no special wiring tools except the wiring tool shown in Figure 16. This applies not only to all individual components of the connecting and isolating terminal blocks, but also to the newly-developed distribution frame racks. The majority of the separate

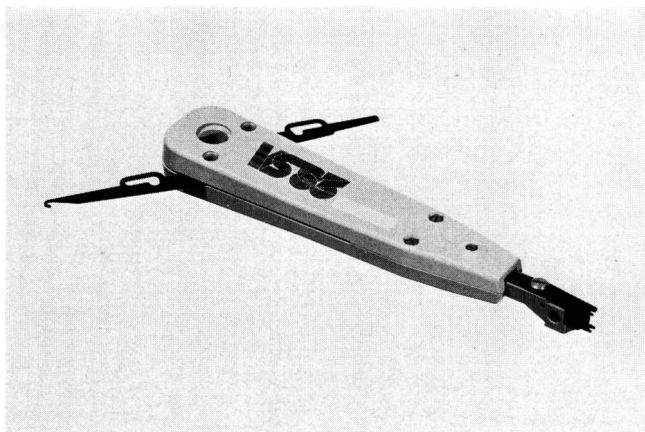

Fig. 16
The VS 83 wiring tool

elements can be joined securely and efficiently by simple snap-on procedures.

A special wiring aid is available to simplify the task of wiring the cable cores (Fig. 17). It provides the following three-functional features:

- It serves as an auxiliary extension element between the rack and the connecting or isolating terminal block, ensuring that the cable conductors form a spare loop with adequate slack.
- It shifts the terminal block forward, making the clamping contacts more accessible and simplifying the task of connecting the wires.
- It permits the approach angle to be adjusted so that the pressing tool can be manipulated with simple and natural motions. This simplifies handling, particularly at the top and bottom areas of the distribution frame.

3 Rack designs

31 General remarks

The new connector system has been designed to cover a wide range of applications in the communications engineering area. It must therefore not only satisfy a great variety of operating conditions, but should also be simple and inexpensive to install. To speed up the introduction to the market it should be possible – at least partially – to continue to use existing connector designs. This approach is particularly important on the subscriber side, since here a wide assortment of racks, cabinets and similar items exist, the replacement of which will take a long time.

These requirements are to a large extent satisfied by the compact dimensions and simple mounting features of the connecting units. As already mentioned, every connecting or isolating terminal block is equipped with a snap-action attachment that permits quick and efficient mounting or removal without the need for tools (Fig. 18).

Connector supports made of sheet metal and designed as rails or strips with defined thicknesses and slots are suitable. Simply designed adapters can be used to facilitate the subsequent installation of VS 83 connector systems in existing equipment.

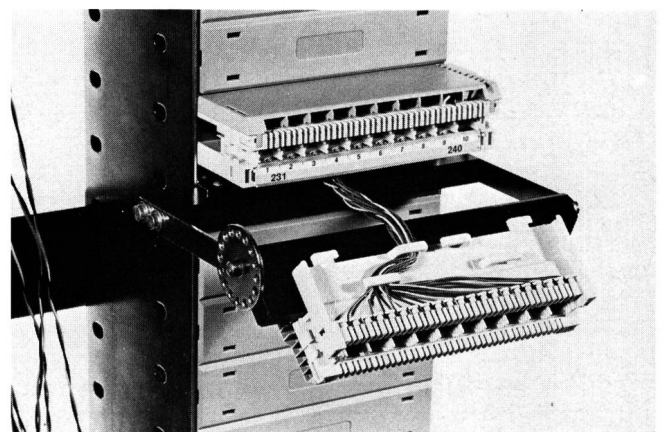

Fig. 17
Adjustable extension to simplify wiring task

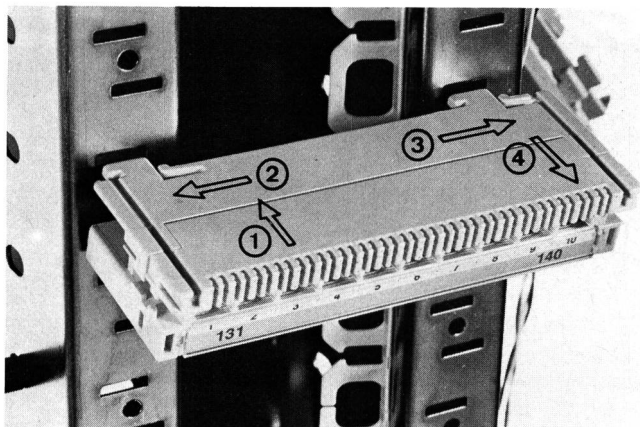

Fig. 18
Mounting or removal of a connecting isolating terminal block

- | | |
|----------------------------|---------------|
| ① Inserting | } Assembly |
| ② Locking onto the frame | |
| ③ Releasing from the frame | } Disassembly |
| ④ Removal | |

32 Main distribution frames in public exchanges

Investigations conducted in public exchanges have established the fact that the currently used division of the connection categories into horizontal and vertical bays will be an advantageous feature even in future designs. In this area existing equipment is therefore being updated to adapt it to the particular requirements of the VS 83 connector system. A prototype of the new main distribution frame for public exchanges is shown in *Figure 19*.

The new public exchanges feature considerably lower rack heights than the designs currently in use. On the other hand, the new switching systems will also be installed in existing exchange buildings with room height greater than 3 metres. The floor space that can be saved with the use of this new distribution frame design de-

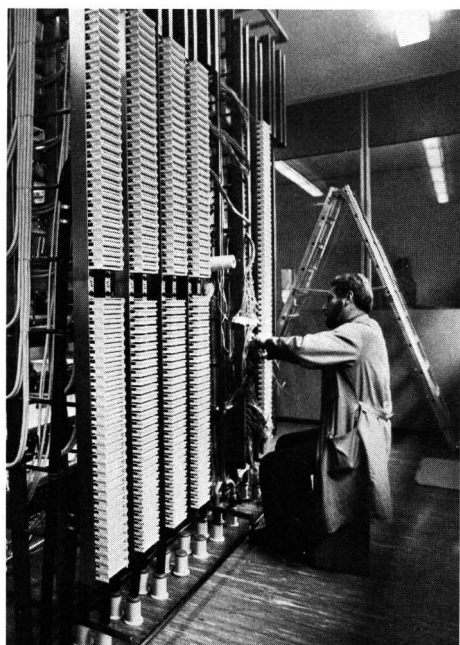

Fig. 19
Main distribution frame (MDF) for public exchanges

pends to a great extent on the use made of the available room height and varies between 25 and 40 %.

33 Main distribution frames for PABXs

On the subscriber side, particularly in conjunction with a PABX, wall or free-standing main distribution frames are used which differ from each other in terms of fundamental design. Wall-mounted distribution frames have so far been suitable only for small and medium-sized installations, since limited floor space was available for the horizontal balancing of the jumper connections and large unobstructed wall areas were needed.

The free-standing main distribution frames used to be similar to the equipment installed in public exchanges, since they also divided the various connector types into horizontal rows and vertically-arranged bays.

The digital PABX systems which are scheduled for simultaneous introduction with the VS 83 connector system offer some new operational features that also affect the layout of the main distribution frame. For example, they permit flexible subscriber number allocations to the effect that every subscriber connection can be assigned any desired number by changing the software data base. If different types of connection are accommodated within the same bay, suitable allocation of subscriber numbers can then be used to ensure that no jumper connections, or at least only individual ones, have to be routed out of this particular bay. The division into a horizontal and a vertical section, which is based on the assumption that every jumper connection requires horizontal balancing, is therefore no longer relevant.

Since the cabling of traditional distribution frames is extremely involved, a basically new frame design was conceived which is optimally adapted to the new conditions. A prototype is shown in *Figure 20*.

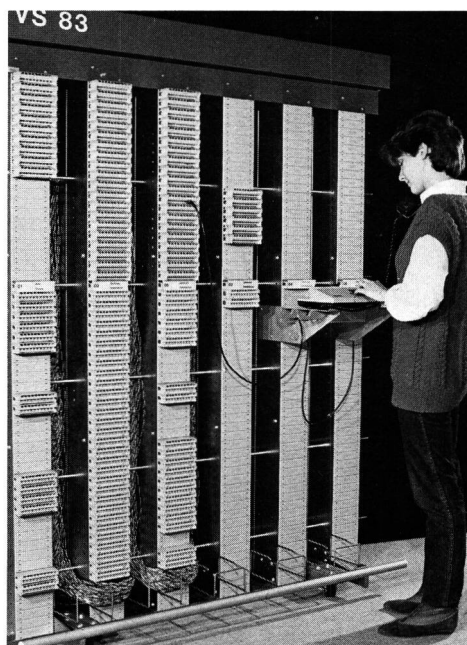

Fig. 20
New main distribution frame for PABX systems

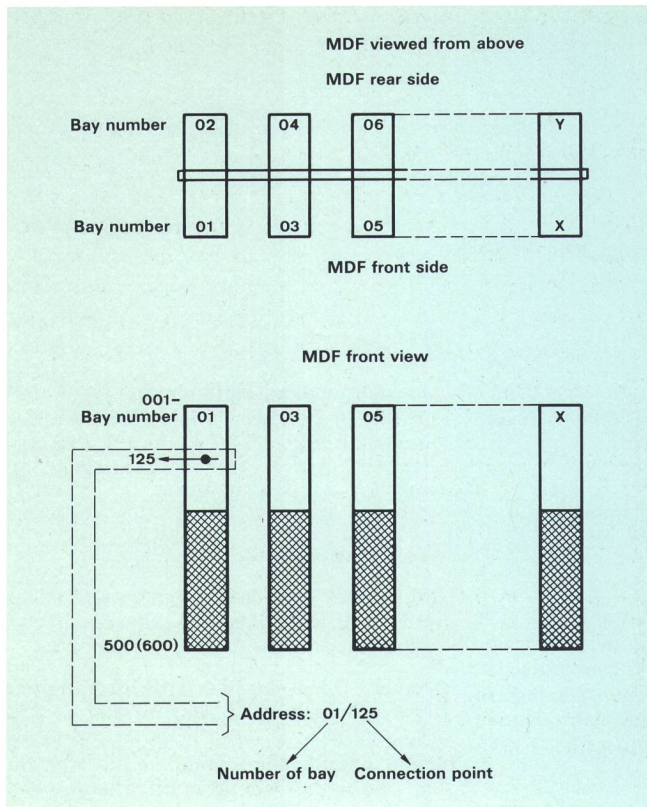

Fig. 21
Square matrix addressing system for a free-standing distribution frame

The main features of this new distribution frame are:

- identical constructional modules for wall and free-standing equipment
- free-standing distribution frames with dual-sided bays and individual horizontal balancing
- supports made of standardized sheet metal channels with integral cable ducts
- 50 or 60 connecting or isolating terminal blocks per bay (other bay configurations may be supplied on request)
- provisions for ceiling or floor-mounted cable lead-ins
- integral ceiling channel
- integral cable grids which permit the attaching and presorting of cables without the need for additional aids (the tying in place or binding of cables is no longer necessary)
- simple installation and modular equipment upgrading options

- matrix-based addressing system (Fig. 21)
- approximately 50 % less floor space required than for traditional distribution frames

The new distribution frame design permits efficient and time-saving equipment handling; it has decisively contributed to the fact that the VS 83 system is no more expensive than the traditional soldering-type system provided that the costs of labour and materials are included in the comparison.

4 Final remarks

VS 83 development work and operational testing by the Swiss PTT are practically finished. The good test results obtained so far have made it possible to commission the first customer installation already in the summer of 1984. Additional installations are scheduled to be put into operation for more operational testing. These tests are being undertaken primarily to obtain some indications as to the problems to be expected from the conversion of traditional distribution equipment to this new connector technology. It is also hoped that the numerous advantages of the VS 83 connector system will be confirmed by actual field trials. The general introduction of VS 83 in the subscriber area started in spring of 1985.

In the public exchange sector the new connector system will be tested in three traditionally equipped telephone exchanges. Since these tests require much longer time spans for planning and practical execution, the operational trials will last until the end of 1985. On this basis the general introduction of the VS 83 will coincide with the introduction of the first digital exchanges in 1986.

The VS 83 connector system can also be applied in other areas as a result of its operational versatility. For example, it is planned to equip future telex and Telepac exchanges with this new connector system.

The practical experience derived from pilot trials allows the fully justified assumption that the original equipment specifications for a solderless, floorspace-saving and low-cost connector system to replace the solder type in almost every application area have, to a great extent, been fulfilled. It is anticipated that VS 83 will soon acquire a strong market position and will find additional application areas. An international marketing survey has indicated that its export prospects are excellent. Various agencies have already applied for a distribution agreement or a manufacturing license for territories outside of Switzerland.