

# Elements of Jura kinematics and dynamics

Autor(en): **Laubscher, Hans P.**

Objektyp: **Article**

Zeitschrift: **Eclogae Geologicae Helvetiae**

Band (Jahr): **72 (1979)**

Heft 2

PDF erstellt am: **21.07.2024**

Persistenter Link: <https://doi.org/10.5169/seals-164848>

## **Nutzungsbedingungen**

Die ETH-Bibliothek ist Anbieterin der digitalisierten Zeitschriften. Sie besitzt keine Urheberrechte an den Inhalten der Zeitschriften. Die Rechte liegen in der Regel bei den Herausgebern.

Die auf der Plattform e-periodica veröffentlichten Dokumente stehen für nicht-kommerzielle Zwecke in Lehre und Forschung sowie für die private Nutzung frei zur Verfügung. Einzelne Dateien oder Ausdrucke aus diesem Angebot können zusammen mit diesen Nutzungsbedingungen und den korrekten Herkunftsbezeichnungen weitergegeben werden.

Das Veröffentlichen von Bildern in Print- und Online-Publikationen ist nur mit vorheriger Genehmigung der Rechteinhaber erlaubt. Die systematische Speicherung von Teilen des elektronischen Angebots auf anderen Servern bedarf ebenfalls des schriftlichen Einverständnisses der Rechteinhaber.

## **Haftungsausschluss**

Alle Angaben erfolgen ohne Gewähr für Vollständigkeit oder Richtigkeit. Es wird keine Haftung übernommen für Schäden durch die Verwendung von Informationen aus diesem Online-Angebot oder durch das Fehlen von Informationen. Dies gilt auch für Inhalte Dritter, die über dieses Angebot zugänglich sind.

# Elements of Jura kinematics and dynamics

By HANS P. LAUBSCHER<sup>1)</sup>

## ABSTRACT

A combination of different types of mass transport was involved in Jura deformation, but the most important was movement of rigid blocks resisted by friction on the bounding shear zones. The blocks are of vastly different sizes, and are organized hierarchically into subsystems and systems of increasing regionality. The shear zones may be almost discrete surfaces: thrusts, dextral and sinistral wrench faults, decollement surfaces; or they may be distributed (diffuse). One type of such distributed shear zones, in effect, are the kink bands with rounded hinges and other adjustments reducing volume changes during rotation, of which Jura folds are composed. Friction on block boundaries usually resulted in repeated fracture, particularly tensional, with mutual indentation and ploughing of blocks; it was eased by ubiquitous stylolitization in limestones. Oblique stylolites on surfaces of compressional shear are the rule, and obstacles to shear are generally subject to abundant pressure solution. However, pressure solution (stylolites: sources) is largely compensated in limited domains by precipitation in calcite veins (tension cracks, or shears later converted into extension cracks: sinks).

## ZUSAMMENFASSUNG

Verschiedene Arten von Massentransport sind an der Jurafaltung beteiligt. Weitaus am wichtigsten ist die durch Reibung behinderte Scherbewegung relativ starrer Blöcke. Diese bilden zusammen Bewegungssysteme verschiedenen Maßstabs, wobei lokalere Systeme hierarchisch in regionalere zusammengefasst und ihnen untergeordnet sind. Die begrenzenden Scherzonen können fast diskrete Oberflächen sein: Abscherungen, Überschiebungen, dextrale und sinistrale Horizontalverschiebungen; sie können aber auch diffus, durch breitere Gürtel verzettelt sein. Zu diesen verzettelten Scherzonen können auch die Knickbänder mit gerundeten Scharnieren gezählt werden, aus denen Jurafalten grösstenteils zusammengesetzt sind: Indem durch allerhand geometrische Anpassungen während ihrer Rotation eine Volumänderung minimiert wird, sind sie gleichwertig einer einfachen Scherung parallel zu den Bändern. Reibung an den Blockgrenzen führt in der Regel zu weiteren Frakturen, besonders Zerrbrüchen, wobei die Blöcke sich verzahnen und durchpflügen können. Diese Reibungserscheinungen werden jedoch gemildert durch überaus häufige Drucklösung (Stylolithenbildung in den Kalken). Schrägstylolithen an Scherflächen mit einer Kompressionskomponente sind die Regel, und Unregelmässigkeiten in den Scherflächen sind gemeinhin stylolithisiert. Die Drucklösung ist jedoch örtlich kompensiert durch Kalkausfällung in Zerrklüften; Abschätzungen der Massenbilanz ergeben, dass keine grösseren Mengen gelöster Substanz den Faltenjura verlassen haben.

## Introduction

Jura deformation is dominated by shearing displacement of rigid masses, separated by thrusts, kinkbands, and wrench faults. This makes it a minor version of plate tectonics (LAUBSCHER 1965). The shearing zones are governed by solid friction

---

<sup>1)</sup> Geological Institute of the University, Bernoullistr. 32, 4056 Basel (Switzerland).

- which is a collective term for a large number of individual mechanisms such as ploughing and cataclastic flow (compare BYERLEE & WYSS 1978, PATERSON 1978), which on a molecular level are composite processes again - along with "viscous" pressure solution (concentrated on stylolites in limestones, diffusely distributed in evaporites, LAUBSCHER 1975). The deformational system is hierarchically composed of subsystems of ever smaller scale, and processes on different scales work together in a way that has been under investigation for many years but is not yet fully understood though some aspects are rather clear now.

Tectonic deformation is a term that is variously defined as a penetrative change of shape or more loosely as the relative displacement of rocks with respect to some standard frame such as the foreland of the Jura. In this looser sense it involves several types of mass transport. Mass transport is most generally - and I think meaningfully - described in terms of source, path of transport, and sink, where the transported matter finally comes to rest, or escapes the boundaries of a defined system. It sometimes creates confusion that in geology sources may be at a lower level than sinks, e.g. lava sources which may be deep down in the asthenosphere whereas the sink may be on a mountain, a volcano. Likewise the distant source of decollement of a system such as the Jura may be at a deeper crustal level whereas the sink is at the surface and may even form mountains.

Just as there is a hierarchical nesting of systems and subsystems in Jura deformation, there is a hierarchy of sources and sinks. Estimates of mass balance prove that the main source for the whole system must be south of the Molasse basin but observation demonstrates that there are local sources and sinks, like stylolites and calcite veins. It is an odd fact that the sources and sinks of one subsystem may be the sinks and sources of a complementary subsystem. Thus calcite veins occupy the gaps between masses that have moved apart, they are a source for that movement but at the same time they are a sink for pressure solution; and stylolites develop where masses have been compressed, they are a sink for their movements and at the same time a source for pressure solution.

This article deals mainly with essential aspects of deformation in subsystems of the cm- to m-scale, with some remarks on systems of higher order.

### **Deformation in flat-lying beds**

The simplest type of deformation is encountered in flat-lying, tabular synclines such as that of Liesberg southwest of Laufen, see Figure 1. There are excellent exposures in road-cuts and quarries. The different elements there are encountered individually and, depending on excavation in the quarries, sometimes together. In Figure 1 they are part of a simple subsystem of four blocks and their substratum, see Figure 2, where block IV, the local "foreland", is assumed rigidly welded to the substratum.

This seemingly trivial elementary subsystem already involves a series of problems that are fundamental for larger-scale systems. A helpful quantity here is the displacement vector  $u_i$  (using a notation widely applied in continuum mechanics, the subscript  $i$  representing 1, 2, 3;  $u_1$ ,  $u_2$ ,  $u_3$  being the  $x$ ,  $y$  and  $z$  coordinates in a Cartesian system). Compatible motions of the several blocks may then be construct-

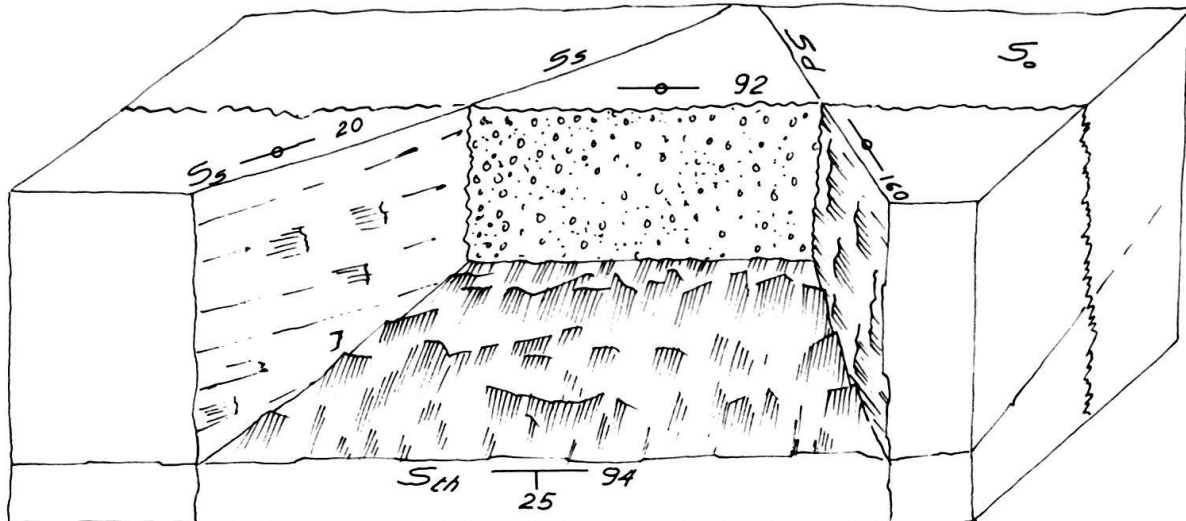

Fig. 1. Tectonic elements in the tabular syncline of Liesberg (Quarry coord. 601.6/250.1).

Conjugate dextral ( $S_d$ ) and sinistral shears ( $S_s$ ), conjugate thrusts ( $S_{th}$ , here south-dipping) and vertical stylolitic surfaces ( $S_{st}$ ). The different shears here are mostly coated by calcite sculpted into the typical calcite steps that are sure indicators of relative displacement but are often confused with other types of sculptures (tectoglyphs), particularly oblique stylolites, see Figures 5 and 6. All these features are excellent and harmonizing indicators of the local direction of maximum compression  $\sigma_1$  at a particular moment. Though this textbook arrangement of elements prevails, deviations are not very rare.

ed by vector addition as is done in plate tectonics. Consider here only the simpler 2-dimensional system of Figure 2. Assume the displacement vector  $u_i^I$  of block I to be perpendicular to the stylolite surface  $S_{st}$  bounding IV, as required by the striations  $S_{th}$  on the thrust in Figure 1. Then there are many possibilities for the relative movements of II and III. If they are constrained by the postulate that relative displacements II/I and III/I are boundary-parallel shears amounting to the shear component of  $u_i^I$ , then  $u_i^{II}$  and  $u_i^{III}$  are uniquely determined and are equal to the normal components of  $u_i^I$  (Fig. 2). Their amount is smaller than that of  $u_i^I$ , and they are divergent. The stylolite columns  $C_{st}$  at the II/IV and III/IV boundaries are oblique, and striations at their base are parallel to  $u_i^{II}$  and  $u_i^{III}$  and are consequently divergent from those below I. There are two bands where they will be superposed by the  $u_i^I$  striations: This is the simplest case of crossed striations which abound in the Jura (compare Fig. 13). Other possible constraints are shown in Figure 2b. Such situations are frequent though their quantitative importance is unknown at this moment: often statically complementary sets of shears are activated kinematically in different ways. Frequently one set develops stylolites whereas the other is smooth, comparable to Figure 2b (compare also "smooth" and "rough" joints of GLAUSER 1960), or one or both are transformed into extensional calcite veins (Fig. 13).

The importance of this for larger-scale structures is obvious. It implies lateral mass movement, other than parallel displacement vectors connecting the source in the Alps with the sinks in the Jura. I have some time ago (1961, 1965) developed two very simple overall models for Jura kinematics. Model 1 implied only rotations around a pivot at the eastern tip of the Jura mountains, allowing no lateral transport. Model 2 permitted divergent translation in the western Jura along dextral

faults, and lateral push of western blocks along the sinistral wrench faults similar to that of Figure 2b. The subsystem of the Rheintal Jura (1965, Fig. 6) allowed for no lateral movement. This was a gross simplification, of course, and several observations in the eastern Jura including observations of the nature of Figure 2 or 13 as well as lateral variations in anticlinal compression (compare e.g. HECKENDORN 1974)

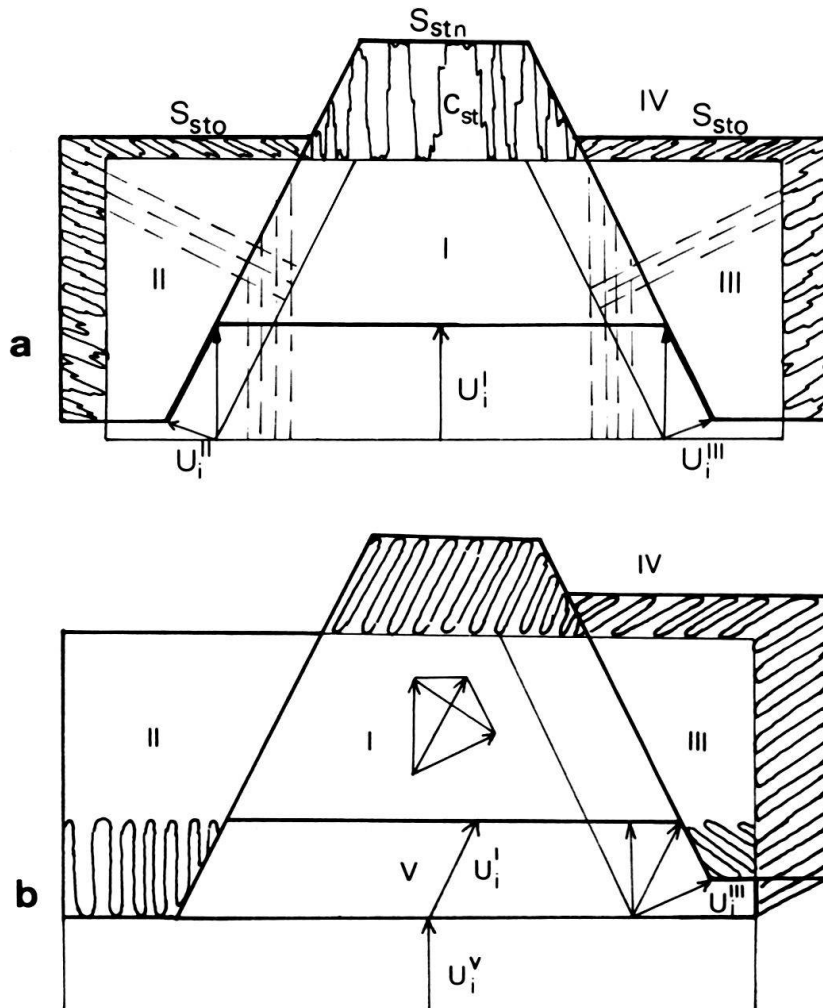

Fig. 2. Different (extreme) kinematic possibilities related to the arrangement of Figure 1.

- (a) The displacement vector  $u_i^I$  of block I is parallel to that direction of maximum compression  $\sigma_1$  when fracture occurred. The foreland block IV extends into the footwall of the thrust  $S_{th}$  and remains fixed. Excess matter between I and IV is dissolved on stylolite surface  $S_{sm}$  with column orientation normal to the surface. Movement of blocks II and III is subject to the condition that they are pushed aside by the normal components (with respect to  $S_s$  and  $S_d$ ) of  $u_i^I$ , which thus corresponds to the displacement vectors  $u_i^{II}$ , and  $u_i^{III}$ . Relative displacements between I and II (III) are the tangential components of  $u_i^I$  with respect to  $S_s$  ( $S_d$ ). On  $S_{st}$  oblique stylolites are formed ( $S_{sto}$ ) parallel to  $u_i^{II}$  ( $u_i^{III}$ ), which is also the direction of striations on  $S_{th}$ . Notice also the bands of superposed crossing striations.
- (b) Another possibility which according to observations is frequently realized to some degree is asymmetrical behavior of II and III. Conditions here are: II remains fixed like IV; I moves parallel to  $S_s$ , and III is pushed away by the normal component of  $u_i^I$  with respect to  $S_d$ . A fifth block V in the rear moves in the direction of the original  $\sigma_1$ . Relative displacements of blocks may be seen as difference vectors (corresponding to stylolite columns  $C_{st}$ ) on the vector diagram. Which of the many possible kinematic situations will materialize depends on boundary resistances.

suggest that lateral mass transport, though clearly of minor importance, played some role, but quantification is hard and has not yet been attempted.

On a much larger scale a lateral push of blocks (subplates) caught in the Africa-Eurasia convergence zone is required by the dextral slip on the North Anatolian fault as pointed out by MCKENZIE (1972), and has more recently been postulated in Central and Eastern Asia by MOLNAR & TAPPONNIER (1975): This is a reminder of the fact that block kinematics rules are valid on all scales.

The subsystem of Figure 2 is cut out from a larger context and poses the problem of compatibility of the simultaneous movement of a large number of blocks. The compatibility conditions in continuum mechanics are an important set of equations governing the geometry of the deformation field. The general simplified situation is that as a stress field builds up there will be a static system of curved trajectories of principal stresses which dictate the geometry of static fractures (for the Jura compare LAUBSCHER 1972). Finite movements of the resulting block mosaic are constrained by the rules of rigid body kinematics and consist of rigid translations and rotations. Except for trivial situations there is no solution that allows for simple shear along all block boundaries, without local compressive (sink) and extensive (source) adjustments. Such adjustments are observed in virtually every outcrop, and are illustrated in the figures of this article. One of the fundamental questions of Jura tectonics is that of the regionality of a system of adjustments as sampled in a given outcrop. In view of the scarcity of observational samples this question may never be answered completely but will have to be dealt with by mechanically and geologically reasonable conjectures (compare also LAUBSCHER 1976). Attempts at a statistical grouping of elements have not been helpful so far.

### Intersection of dextral and sinistral shears

One important problem of kinematic compatibility, arising at the very beginning of deformation, is what happens where wedges bounded by dextral and sinistral shear  $S_d$  and  $S_s$  converge. Figure 3 illustrates the simplest case: excess material is dissolved in a stylolite zone. This situation may have been approximated by  $S_{st}$  in Figure 1. However, different geometries are quite frequent. In Figure 3, the bounding shear planes are simultaneously active. If instead they move alternately, the situation of Figure 4 arises. The significant difference is that the orientation of  $C_{st}$  changes according to which shear is active, and is dominated by the latest. This is observed frequently, see Figures 5 and 6. Here one is tempted to assume several

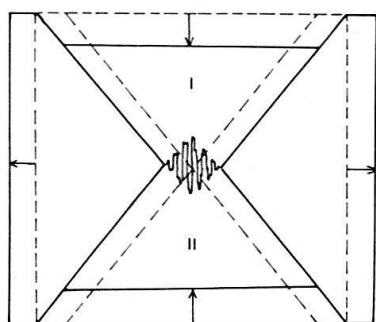

Fig. 3. Interference of  $S_s$  and  $S_d$  which are simultaneously active. Excess matter removed by pressure solution (length of  $C_{st}$  equivalent to relative displacement I/II).

alternations because the stylolites in the interference band are in well developed though somewhat irregular tiers. This implies maximum dissolution of that segment of the sinistral shear plane  $S_s$  participating first in the abrupt displacement of  $S_d$  and therefore exposed first to stylolitization by shear along  $S_d$ , and minimum dissolution

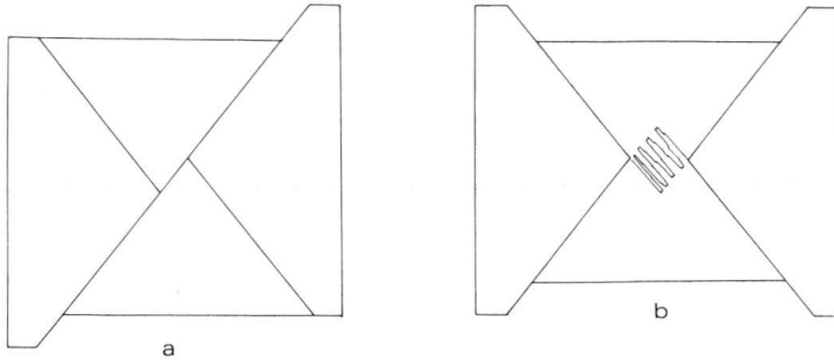

Fig. 4. Interference of  $S_s$  and  $S_d$  which are sequentially active.

(a) Movement on  $S_s$  introduces dogleg on  $S_d$ . (b) Movement on  $S_d$  has to cope with this obstacle, in this case (frequently observed in limestones) by removing excess matter through pressure solution. Amount of excess matter is the same as in Figure 3, but  $C_{st}$  are parallel to  $S_d$ .

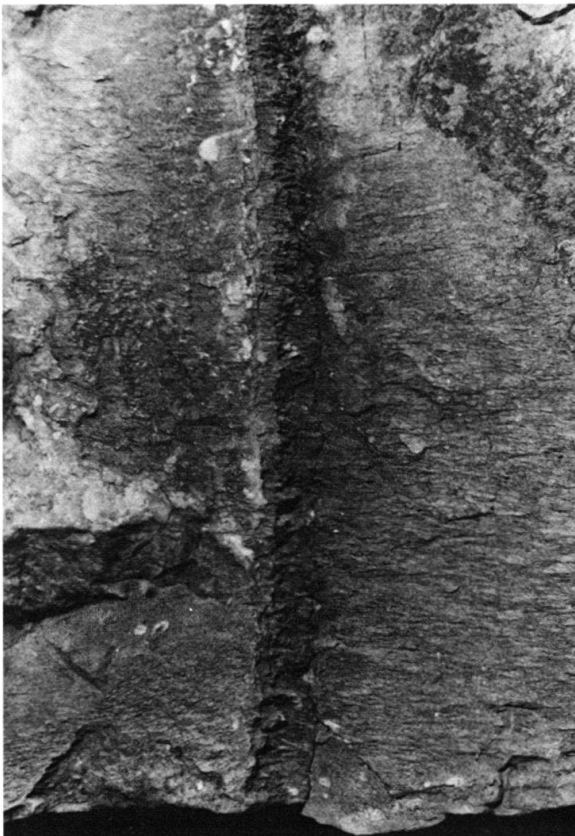

Fig. 5. Stylolite tiers on sinistral obstacle in  $S_d$ , slightly northdipping fine-grained limestones south of Seewen (Canton of Solothurn). For explanations see Figure 6 and the text.

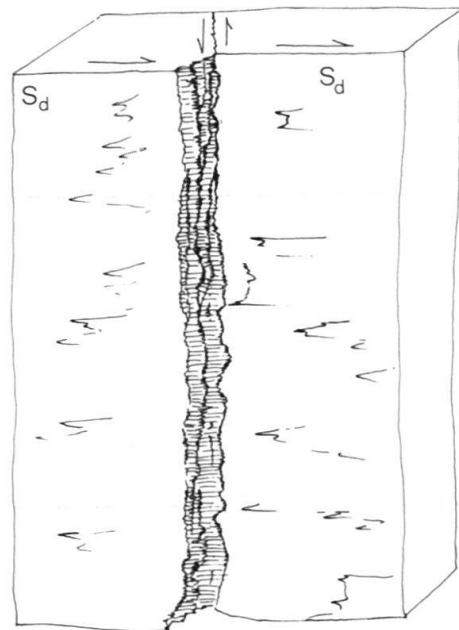

Fig. 6. Schematic drawing of a block containing Figure 5. The tectoglyphs on  $S_d$  are low angle dextral stylolites which are sometimes confused with calcite steps (compare Fig. 1) and then give the wrong sense of movement.

of that part exposed last. The staggered occurrence of the stylolite tiers would suggest episodic activation of the sinistral shear, followed by dextral shear and stylolitization. However, the mechanism for accomplishing this is not immediately transparent because of the superposition of dextral and sinistral stylolites. This circumstance calls for a somewhat more thorough exploration of possible mechanisms, see Figures 7 and 8.

Figure 7*a* shows the interference after the first episode of sinistral but before dextral slip. The dextral surface  $S_d$  is now dog-legged, and several things may happen at the obstacle. In Figure 7 only pressure solution is assumed but there are instances – see Figure 13 – where fracture was initiated.

In Figure 7*b* solubility of blocks I and II on opposite sides of the obstacle is considered equal on the average, and maximum length of stylolites  $C_{st}$  is assumed, corresponding to the total amount of compression – an assumption already made for Figures 2, 3, and 4. These two ideal assumptions will not generally be realized in nature. Extreme cases are illustrated by the Figures 7*c* and 7*d*, where solubility of blocks II and I, resp., is zero. In Figure 7*e* solubility of I on average is less than that of II, but not zero, and there is partial interpenetration. In Figure 7*f* relative solubility of the two blocks varies from  $A$  to  $B$  in a regular way and this, without recourse to several alternating slip episodes, might conceivably result in staggered stylolites. Reasoning for this possibility runs as follows. Pressure solution can proceed only if dissolved matter may be removed as increasing concentration of the pore fluid increasingly slows down the rate of dissolution: the faster the removal of dissolved matter the greater the rate of dissolution. Avenues for removal are  $S_s$  and particularly  $S_d$  which is in an active and quite possibly somewhat dilatant episode. Points  $A$  and  $B$  will be the gates for escape of dissolved matter and the rate of solution will be greatest near them. Thus there will be a successive dextral shift of stylolites from  $A$  to  $B$ ; however, whether this be gradual or jerky is not predictable by such qualitative considerations.

Staggering of stylolites by episodically alternating shears might work as illustrated in Figure 8. A sinistral shear superposed on dextral stylolites would produce a situation approximately as shown in Figure 8*b/c*: The already stylolitized rock volume is invaded by films along which solution may proceed at a much faster rate than in the virginal rock; for simplicity it is assumed that the entire solution takes place in the previously stylolitized rock, preferably at the moving contact with the healthy rock, but this is not important. There is now a stepped solution front. Superposition of a dextral episode, using the same criteria for the rate of solution, results in stepped dextral stylolites comparable to those in Figure 5: equal penetration at healthy rock contacts; dissolution of already existing stylolites in the middle. These assumptions may be relaxed without changing the essential result: a staggered arrangement of the stylolites.

Complications multiply in the hinges and limbs of folds (compare LAUBSCHER 1976). A complex array of shear and tension surfaces appears, all of which are discontinuities which at one stage or another may promote pressure solution. The possible combinations are of too confusing a variety to be systematically and exhaustively treated here; instead a few real examples will be described and, to a certain point, analyzed.



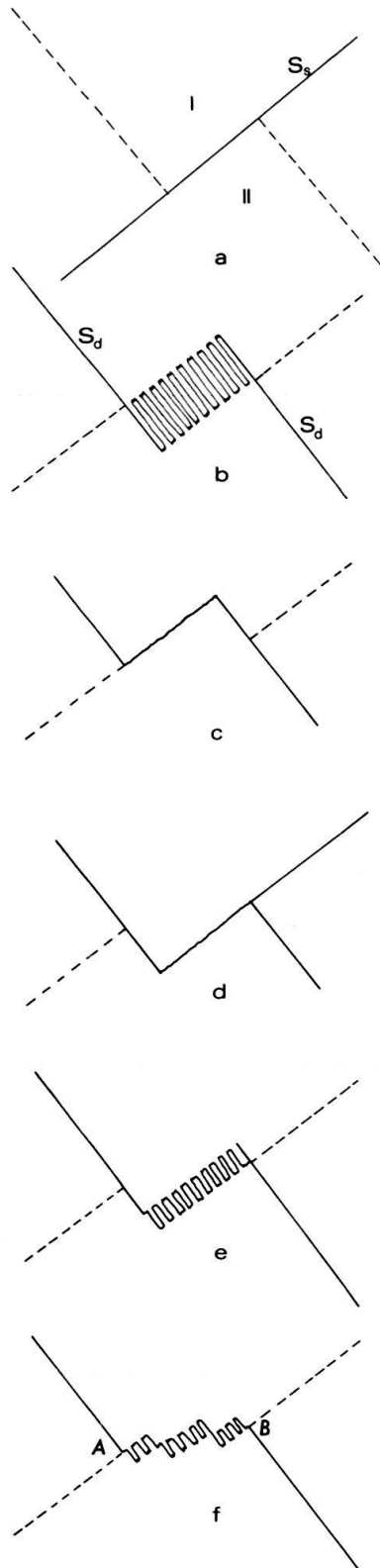

Fig. 7. Different possible modes of pressure solution on a sinistral obstacle in  $S_d$ . This scheme also applies to any shearing surfaces with obstacles. As shearing surfaces are never smooth to begin with, such phenomena are ubiquitous. They are particularly striking where bedding is slightly displaced along thrusts, reverse, or normal faults: pressure solution fronts move with the less soluble layers in the direction of the more soluble ones, and large surfaces of tiered stylolites develop. Explanations in the text.

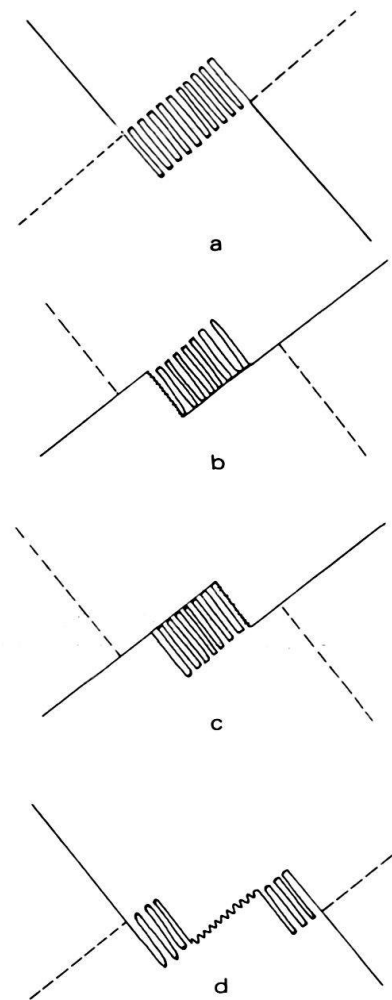

Fig. 8. A special mode of development of tiered stylolites by alternating activation of  $S_s$  and  $S_d$ , possibly applicable to Figure 5. Explanations in the text.

One of the earliest set of fractures sometimes observed in dense (micritic) limestones (Fig. 9) are often dense networks of very thin cracks. They show up on weathered surfaces but are hard to recognize on polished surfaces or in thin sections; they may be beautifully decorated by extremely thin films of organic material and oxides in specimens which have been buried in the soil. They look so different from the ordinary shear and tension fractures that for a while I have been tempted to associate them with diagenetic water-escape mechanisms, similar to those in turbidite sands (LOWE 1975). However, further observation has shown that by and large their geometry fits the Jura stress field and that they must be the result of one of the mechanisms of Jura folding. At the moment I can only speculate about their origin.

Density of the network, early appearance, and lack of noticeable displacement suggest an initial, rather ductile (distributed) deformation before the development of large-scale fractures. Taking the cue from experiments (review in PATERSON 1978)



Fig. 9. Compare also Figure 16 of LAUBSCHER (1976), which is the continuation in the right upper corner. The dense network of hair cracks is on the average fairly regular. There are two main sets intersecting at about  $30^\circ$ , with the bisectrix parallel to  $S_0$ . However, puzzling departures are common such as the circular pattern in the lower center. The cracks here seem to predate all other tectonic features. In other outcrops they have been found in micritic limestones of higher stratigraphic levels tilted no more than  $20^\circ$  which confirms early development. In one outcrop they were geometrically related with early tension cracks. In the particular case here illustrated they appear in the  $30^\circ$  to  $40^\circ$  dipping beds of a south-facing kink band but continue across the upper hinge into the very gently dipping north limb which suggests that they preceded kinking. Further explanations in the text.

one would conjecture a late stage of dilatant microcrack formation possibly associated with a sudden increase in brittleness, converting the microcracks into a dense network of fractures. Under the specific geologic conditions at hand this might correspond to the following situation. Initial compression of the stratigraphic sequence has different effects on different members. In the porous, particularly the shaly ones a reduction of primary pore space, an increase of pore pressure, and squeezing out of pore fluid is implied, whereas in the dense limestones, which are stress guides, disseminated dilatant microcracking would be expected. At a certain point the system of presumably low-pressure microcracks is opened to the high-pressure pore fluid and this entails a sudden increase of brittleness and in some cases the explosive fragmentation well-known from confining pressure experiments at failure of the sample jacket.

Next there are the elements already described (Fig. 1 and 5), though sometimes with altered functions associated with folding (cf. LAUBSCHER 1976). For instance, of the two complementary thrust fractures one is often used as an extension crack due to bed slippage.

Bed slippage, and finite shear on other surfaces, create a series of additional features (see WEGMANN & SCHAER 1956). Indentation of one bed into the other and subsequent ploughing assumes a variety of aspects. Very curious yet of simple geometry are the indentation holes in a thrust plane near Choindez, Jura Canton

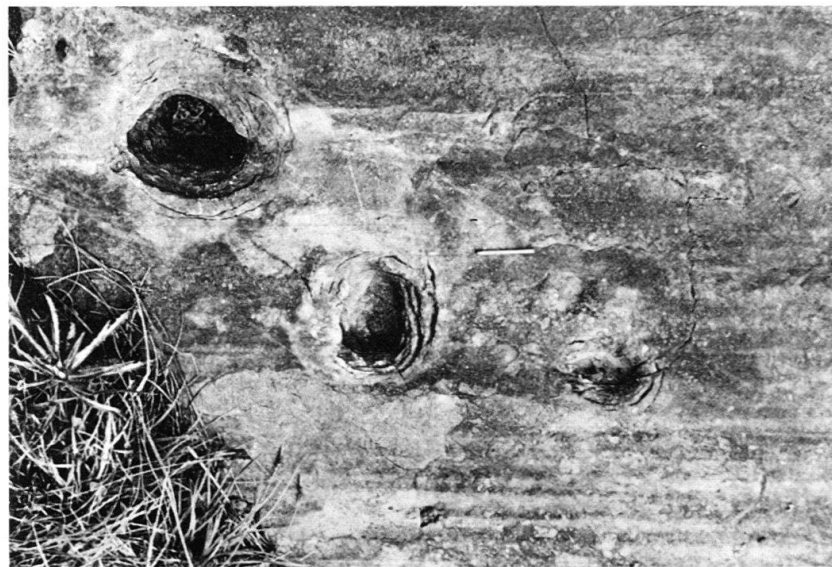

Fig. 10. Indentation and initial ploughing in a thrust zone near Vellerat (Canton of Jura). Shown is the footwall in cataclastic Oxfordian limestones. The main direction of thrusting is given by the striations (tip of match is head of the arrow). The actual indenters have been dissolved but remnants indicate irregularly bedded siliceous limestones from the base of the Oxfordian limestone section (Liesberg limestones): these also occur as a thin tectonic sliver in the thrust zone a few meters farther west and disintegrate into small fragments towards the place where the picture was taken. It is conjectured that such tectonic pebbles were impressed into the not yet recrystallized mobile cataclastic mass of the footwall, but that the hanging wall, consisting of incompetent Lower Oxfordian shales during the later stages of thrusting, was detached from the indenters which then were left as inert constituents of the footwall. The pattern of circular tension cracks suggests wobbly movement with a phase of lateral displacement. From WOHNLICH (1967).

(compare WOHNLICH 1967), see Figure 10. Somewhat less extreme examples of indentation with concentric and radial fracture patterns are often observed (for an example compare WOHNLICH 1967). They are transitional to the partial shearing off of portions belonging to one bed by the adjacent one with more or less extensional fragmentation of the resulting slice; sometimes this results in trails of tectonic breccia (review in PATERSON 1978, p. 95).

An early and incomplete stage is that of Figure 11. Here the extension cracks penetrate only the upper part of a bed which consequently has been sheared off from the rest though no well-defined shearing surface is visible. Figure 12 shows a more advanced stage. Lenticular volumes on the order of  $m^3$  are densely fractured by tensional cracks as they are caught between coalescing shear planes, one of which is usually a bedding plane. As seen on the bedding plane, the tension fractures are usually crescent-shaped, forward concave features comparable to those of Figure 10.

Figure 14 is the picture of a specimen from a severely deformed zone near Montsevelier (Jura Canton). Here a combination of several different features is concentrated in a small space.

First, there are structures due to a principal, and apparently very early, compressional system as implied by: 1. The orientation of the main stylolite surfaces. 2. The direction of the main calcite veins which intersect at 50 to 60 degrees, with the bisectrix about perpendicular to  $S_{sr}$ . They are evidently conjugate shears of the early compressional system, later used kinematically for lateral extension. 3. Radiating patterns ( $r$ ) of primary tension joints that seem to originate particularly at points where the shear fractures deviate from their functional orientation. This incipient

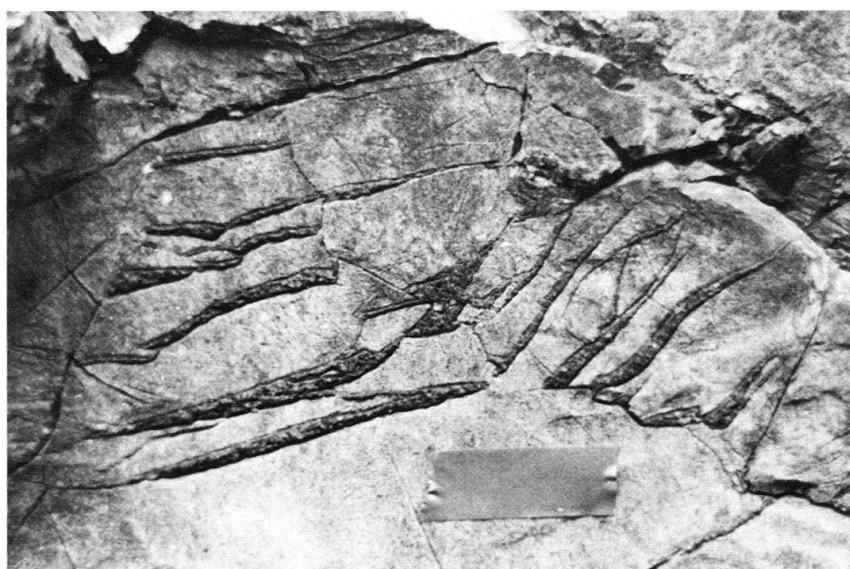

Fig. 11. Another detail from the south-facing kink band in Lower Oxfordian limestones south of Seewen, Canton of Solothurn, shown in LAUBSCHER (1976, Fig. 13 and 14 upper center). This and adjacent beds, in the surroundings of the figure, are characterized mainly by (a) numerous veins dipping at low angles with respect to bedding and considered static thrust joints kinematically converted to échelon gashes, and (b) vertical and  $S_0$  stylolite joints. The pattern of cracks shown in the figure is restricted to a domain near the surface of the bed and is interpreted as shown in Figure 12. Length of marker is 5 cm.

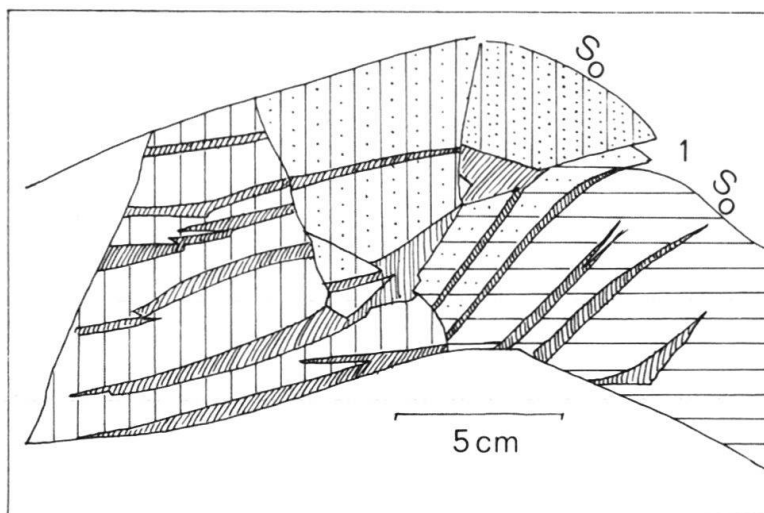

Fig. 12. Schematic drawing of Figure 11, suggesting the block kinematics of this particular domain. At (1) the upper bed plows into the lower one, breaking off, lifting, and rotating the subdomain marked by vertical ruling. The partial subdomains additionally marked by rows of dots are wedged out of the bed by the horizontally ruled subdomain which is dragged along by the upper bed and pushed by frictional transmission of its movement into the gap opening below the escaping wedges; in the process this subdomain is broken into fragments by tension gashes. The lower boundary of this subdomain is jagged with partial stylolitization. The boundaries in the left of the figure apparently have initially been joints of unknown static origin, probably converted into stylolites in a first prefolding phase (compare Fig. 1), then kinematically used for shearing adjustment of unequally extended subdomains during rotation of the beds and finally been stylolitized a second time. The 3-dimensional kinematics has not been explored.

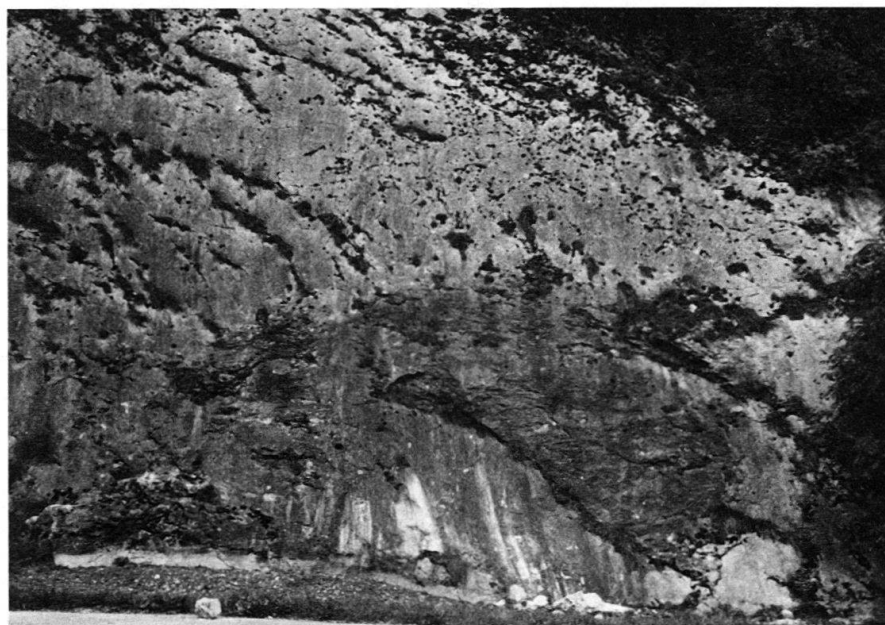

Fig. 13. South limb of Bueberg fold, Lower Oxfordian coral limestones, Birs valley at Bärschwil Station. The somewhat poorly developed bedding planes are supplemented by communicating shear planes. A lower shear plane is characterized by calcite lining and conspicuous striations; it is partly covered by lenticular masses dragged along by upper beds and drawn out and fragmented by tension gashes in the process – a phenomenon similar to that shown in its initial stages in Figures 11 and 12, but much farther developed. Compare also LAUBSCHER (1976, Fig. 17), which is from the left center of the picture.

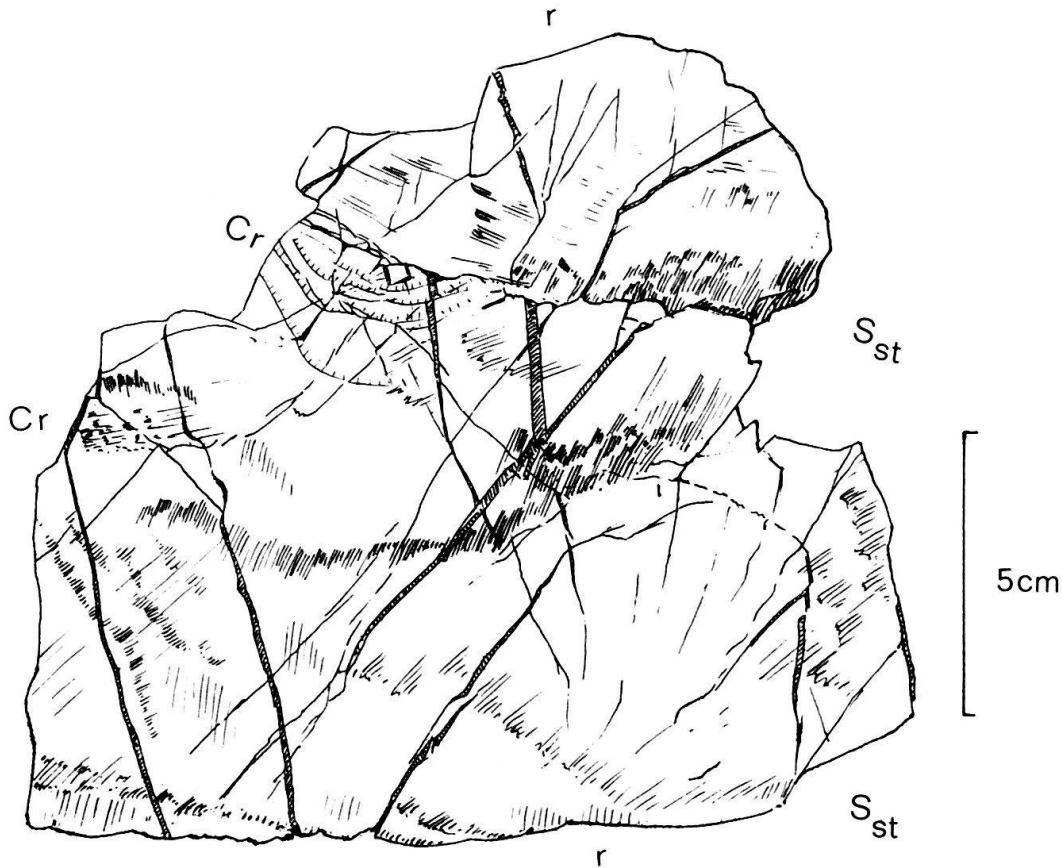

Fig. 14. Specimen of upper Jurassic limestone from severely deformed zone near Montsevelier (Canton Jura):  $S_{st}$  = main stylolite surfaces,  $Cr$  = crescent-shaped steps,  $r$  = radiating fracture patterns. Explanations in the text.

crushing is an alternative to pressure solution at an obstacle as shown by Figure 5. There is a certain tendency to develop concentric fractures orthogonal to the radiating pattern. 4. One set of striations with oblique stylolitic interpenetration on  $S_o$ , approximately bisecting the calcite veins, and in rough tiers approximately parallel to the main stylolites. Later features are: 5. Crescent-shaped tension steps in  $S_o$  implying upward slip of the upper (removed) bed in the direction of the principal striations; 6. several sets of oblique striations and stylolitic tiers implying variable components of lateral movement; 7. lateral extension on the shear fractures. This extension, though subsequent to initial fracturing, evidently took place during continued pressure solution on the main stylolites.

In steeply dipping to overturned beds which would be classified as "beyond the locking position" of the corresponding kink band there is a system of features emphasizing stretching of beds and strong compression perpendicular to bedding, see Figure 15 (compare also LAUBSCHER 1976, Fig. 18 and 19). The main phenomenon, colloquially referred to as "lensing", is associated with tension veins that are related to boudinage as known from metamorphic terrains. Boudinage occurs where in competent beds tensional stresses are set up by the ductile stretching of neighboring incompetent beds. In Figure 15 bed-normal compression is taken up to a considerable extent by pressure solution on sheared-off parts of the bed. These stylolites are sometimes hard to distinguish from originally stratigraphic ones.

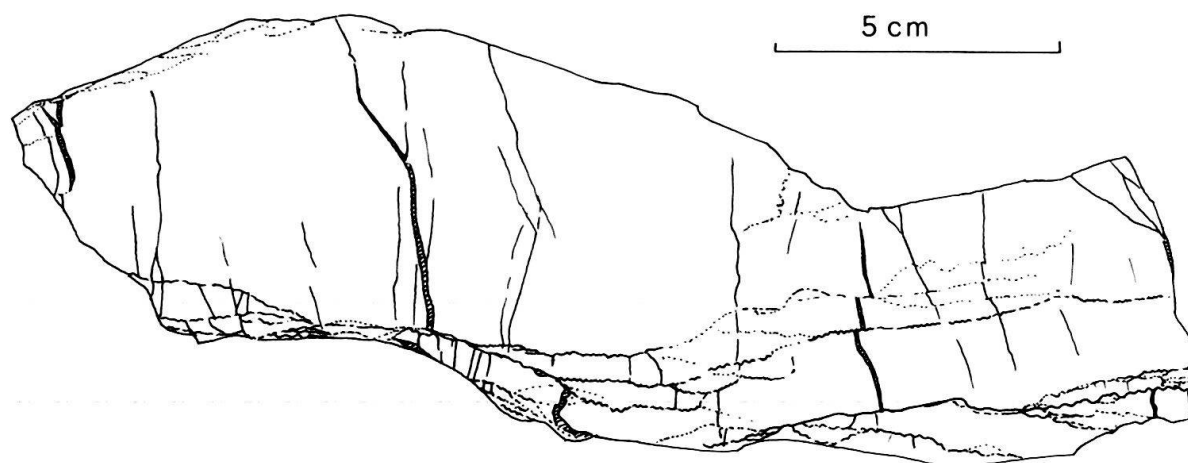

Fig. 15. Kimmeridgian, vertical to overturned north limb of Bueberg fold. Explanations in the text.

There is a hierarchy of such lenticular bodies, and particularly in shaly interlayers they may be small shards, with frequent small patches or veins of calcite, i.e. a geometry similar to that of Figure 15, probably implying a similar process. This process, however, is incompletely understood; a sort of cataclastic flow of calcite-clay systems with pressure-solution flow in the calcite and squeezing away of the shale, the whole stretched in the direction of bedding; an equivalent to limb thinning in slaty or schistose terrain but under much lower  $p$ - $T$  conditions. This stretching would entail formation of the tension veins in competent layers, resulting in a sort of rudimentary boudinage.

The behavior of shale is not frequently amenable to study because of the scarcity of unweathered outcrops; however, observations in the Belchen tunnel and those specimens we have collected there show individual slickensided shear surfaces which in places may form dense networks resembling those in micritic limestone (Fig. 9). Lenticular bodies of some tens of cm or more may be defined by major shearing surfaces which, however, fizzle out into a dense network where they coalesce, and in some places they are joined by glossily slickensided transverse shears which suggest transport of material, this time particulate shaly matter, into the gap arising because of stretching. In a general way, this capacity for diffuse shear in hierarchical patterns seems to be the reason for incompetent, "ductile" behavior of shaly intervals in the Jura; it is a kind of cataclastic flow.

### Deformation of the Triassic anhydrites

The intriguing deformational behavior of anhydrite in the Belchen tunnel has been described and analyzed, though far from exhaustively, in several publications (WOHNLICH 1967, LAUBSCHER 1967, 1975). Three sets of observations here are relevant:

1. Anhydrite has flowed at overburden pressures of less than 300 bars and temperatures hardly exceeding 50 °C, and probably at rates on the order of  $10^{-12}$  sec<sup>-1</sup>. This puts anhydrite deformation into the pressure solution field of the Ashby diagram as modified by RUTTER (1976). The results of the fine experiments

recently published by MÜLLER & BRIEGEL (1978) would confirm this view: anhydrite was found to possess a wide domain of superplasticity which, however, does not extend into the neighborhood of conditions that during Jura folding prevailed in the Jura itself.

2. There is a large number of anhydrite veins in tension gashes and extensional joints. Obviously deformation proceeded in the presence of water (no dry experiments by nature) and large quantities of anhydrite were dissolved and redeposited.
3. Interbedded mudstones may look quite healthy at first sight but in reality are criss-crossed by extremely thin anhydrite veins (WOHNLICH 1967), possibly preformed in the manner of those shown in Figure 9, which testify to a pervasive influence of pressure solution.

I think all this taken together is sufficiently conclusive for ascribing the observed anhydrite flow to a pressure solution mechanism, though not yet demonstrated in the laboratory. Participation of metastable hydrates may be postulated on the grounds of reaction kinetics (compare also HEARD & RUBEY 1966). The equivalent viscosity of this rate process should be similar to that of the flow of alabaster as found by GRIGGS (1940). In the Triassic of the Belchen tunnel pressure solution has worked in conjunction with shearing and cracking of the non-evaporitic layers much in the way described for the limestones, however with pressure solution the dominant process (for illustrations see WOHNLICH 1967 and LAUBSCHER 1975).

### **Folding**

Folds are not sinusoidal but often approach the form of single, complementary, or multiple kink bands with rounded hinges (LAUBSCHER 1977). There is a complex array of minor adjustments throughout such folds, and particularly at the hinges, that tend to keep the volume constant (or reduce volume changes) during rotation. The weight of the evidence shows that these Jura-type kink bands are due to external rotation rather than migrating hinges as those produced by WEISS (movie shown in Lausanne, 1978) in stacks of cards. External rotation of kink bands, while keeping the volume of the band constant by continuous adjustments is in effect the same as simple shear parallel to the band. It would be due to a bending moment because of shearing forces acting parallel to the kink band boundaries rather than to buckling because of bedding-parallel compression. Such moments due to shearing forces may occur within an inhomogeneous deforming body even though there is no external moment; the common example being drag at a fault. Related phenomena are probably en échelon belts of cracks, and externally rotated kink bands may be considered en échelon belts of elements consisting of lengths of beds and interbed joints.

### **Kinematics and dynamics of higher regionality**

When larger subsystems are the object of analysis new problems arise though smaller-scale phenomena must be kept in mind. It is hopeless to try to build up larger-scale models solely from the building blocks described in this article. Esti-



mates of transport vectors must be based on larger-scale information contained in maps and cross-sections, compare LAUBSCHER (1965).

The rules of block (plate) kinematics still apply, and source-transport-sink models based on estimates of material balance are of central importance in kinematics. They reveal, in my judgment unequivocally:

1. The Jura is a decollement nappe, with the main source south of the Molasse basin and its base in the Triassic evaporites.
2. The pressure solution phenomena, so important locally, are largely compensated locally: dissolved matter does not leave the Jura system in large quantities.

*ad 1:* Though slickensided surfaces are numerous north of the Jura, the important features of mass transport such as the wrench faults invariably bring matter from the south (the source) to the north (the sink) and stop at the northern margin of the Jura. Differential underthrusting from the north – the alternative possibility – should create compressions similar to those in the Jura at obstacles (curvature, doglegs in fault planes) north of the Jura, which are not observed; the importance of transcurrent faults should be at a maximum in the northern foreland and, as compressional features branch off on the western side of sinistral faults, decrease to the south – when, in fact, the opposite is true.

*ad 2:* Well-exposed folds and thrusts when straightened out (“curvilinear estimate of compression”) reveal – within the errors of observation – the same amount of compression as that obtained by measuring of squeezed-out volume on a cross-section (“volumetric estimate of compression”). This precludes transport of dissolved matter in large quantities out of these structures.

### Conclusions

Deformation in the Jura consisted of a combination of different types of mass transport.

The overwhelming process was movement of rigid blocks of different orders of magnitude impeded by friction on the bounding surfaces and shear zones: thrusts, dextral and sinistral wrench faults and kink bands. Friction was reduced by pressure solution in the limestones (stylolites) and evaporites wherever there were obstacles to the shearing movement. However, sources and sinks of pressure solution seem to be locally confined systems that do not contribute much to the overall mass transport. Otherwise friction produced systems of secondary shears and tension veins, and often features of interpenetration (ploughing). Boundary constellations changed continually in the course of events, and with them resistance to movement in the various directions. Diverging movements of a changing wobbly nature resulted between individual blocks and composite superblocks of different scales, and crossing striations, stylolitizations and conversion of shear planes into dilational veins or compressive stylolitic bands resulted. Lateral migration also took place on different scales.

Bounding surfaces and zones are usually asymmetrical; in particular, dextral wrench boundaries of larger masses are typically of a distributed, diffuse nature whereas the sinistral wrench boundaries as a rule are faults or narrow fault zones.

Frontal boundaries of smaller blocks may be stylolites but of more important blocks are either thrusts or kink bands with the thrusting ordinarily succeeded by kinking which results in folded thrusts. Kink bands in the Jura appear to be due to external rotation with geometrical adjustments that minimize volume change. They are thus equivalent to simple shear parallel to their boundaries and are apparently due to shearing forces acting in that direction: rotation of beds is due to bending as a result of transverse loading rather than to buckling as a result of axial loads.

## REFERENCES

- BYERLEE, J. D., & WYSS, M. (Eds.) (1978): *Rock Friction and Earthquake Prediction*. – Contr. current Res. Geophys. 6 (Birkhäuser, Basel/Stuttgart).
- GLAUSER, A. (1960): *Kluftsysteme im Malm der Lägern in der Umgebung von Baden*. – *Eclogae geol. Helv.* 52/2 (1959), 853–873.
- GRIGGS, D. T. (1940): *Experimental flow of rocks under conditions favoring recrystallization*. – *Bull. geol. Soc. Amer.* 51, 1001–1022.
- HEARD, H. C., & RUBENY, W. W. (1966): *Tectonic implications of gypsum dehydration*. – *Bull. geol. Soc. Amer.* 77, 741–760.
- HECKENDORN, W. (1974): *Zur Tektonik der Vellerat-Antiklinale (Berner Jura)*. – *Beitr. geol. Karte Schweiz [N.F.]* 147.
- LAUBSCHER, H. P. (1961): *Die Fernschubhypothese der Jurafaltung*. – *Eclogae geol. Helv.* 54, 221–282.
- (1965): *Ein kinematisches Modell der Jurafaltung*. – *Eclogae geol. Helv.* 58, 231–318.
- (1967): *Geologie und Paläontologie: Tektonik*. – *Verh. natf. Ges. Basel* 78, 24–34.
- (1972): *Some overall aspects of Jura dynamics*. – *Amer. J. Sci.* 272, 293–304.
- (1975): *Viscous components in Jura folding*. – *Tectonophysics* 27, 239–254.
- (1976): *Geometrical adjustments during rotation of a Jura fold limb*. – *Tectonophysics* 36, 347–365.
- (1977): *Fold development in the Jura*. – *Tectonophysics* 37, 337–362.
- LOWE, D. R. (1975): *Water escape structures in coarse-grained sediments*. – *Sedimentology* 22, 157–204.
- MCKENZIE, D. (1972): *Active Tectonics of the Mediterranean Region*. – *Geophys. J. r. astron. Soc.* 30, 109–185.
- MOLNAR, P., & TAPPONNIER, P. (1975): *Cenozoic Tectonics of Asia: Effects of a Continental Collision*. – *Science* 189/4201, 419–426.
- MÜLLER, W. H., & BRIEGEL, U. (1978): *The rheological behaviour of polycrystalline anhydrite*. – *Eclogae geol. Helv.* 71, 397–407.
- PATERSON, M. S. (1978): *Experimental Rock Deformation—The Brittle Field*. – Springer, Berlin/Heidelberg.
- RUTTER, E. H. (1976): *The kinetics of rock deformation by pressure solution*. In: *A discussion on natural strain and geological structure, organized by Ramsay, J. G., and Wood, D. S.* (p. 203–220). – *Phil. Trans. r. Soc. London (A)*, 283.
- WEGMANN, C. E., & SCHAER, J. P. (1957): *Lunules tectoniques et traces de mouvements dans les plis du Jura*. – *Eclogae geol. Helv.* 50, 491–496.
- WOHNLICH, H. M. (1967): *Kleintektonische Bruch- und Fliegsdeformationen im Faltenjura*. – Unpubl. Diss. Basel.

