

# Structural geology of the Cordillera Darwin - collisional-style orogenesis in the southernmost Chilean Andes

Autor(en): **Nelson, Eric P. / Dalziel, Ian W. D. / Milnes, Alan G.**

Objektyp: **Article**

Zeitschrift: **Eclogae Geologicae Helvetiae**

Band (Jahr): **73 (1980)**

Heft 3

PDF erstellt am: **21.07.2024**

Persistenter Link: <https://doi.org/10.5169/seals-164987>

## **Nutzungsbedingungen**

Die ETH-Bibliothek ist Anbieterin der digitalisierten Zeitschriften. Sie besitzt keine Urheberrechte an den Inhalten der Zeitschriften. Die Rechte liegen in der Regel bei den Herausgebern.

Die auf der Plattform e-periodica veröffentlichten Dokumente stehen für nicht-kommerzielle Zwecke in Lehre und Forschung sowie für die private Nutzung frei zur Verfügung. Einzelne Dateien oder Ausdrucke aus diesem Angebot können zusammen mit diesen Nutzungsbedingungen und den korrekten Herkunftsbezeichnungen weitergegeben werden.

Das Veröffentlichen von Bildern in Print- und Online-Publikationen ist nur mit vorheriger Genehmigung der Rechteinhaber erlaubt. Die systematische Speicherung von Teilen des elektronischen Angebots auf anderen Servern bedarf ebenfalls des schriftlichen Einverständnisses der Rechteinhaber.

## **Haftungsausschluss**

Alle Angaben erfolgen ohne Gewähr für Vollständigkeit oder Richtigkeit. Es wird keine Haftung übernommen für Schäden durch die Verwendung von Informationen aus diesem Online-Angebot oder durch das Fehlen von Informationen. Dies gilt auch für Inhalte Dritter, die über dieses Angebot zugänglich sind.

## Structural geology of the Cordillera Darwin – collisional-style orogenesis in the southernmost Chilean Andes<sup>1)</sup>

By ERIC P. NELSON<sup>2)</sup>, IAN W. D. DALZIEL<sup>2)</sup> and ALAN G. MILNES<sup>3)</sup>

### ABSTRACT

Recent cruises of the U.S. National Science Foundation's Research Vessel *Hero* in the fjords of southern Tierra del Fuego (Chile) have allowed preparation of the first relatively detailed geologic and structural maps of the Cordillera Darwin, the southernmost, E–W trending, mountain range of the Andes. The Cordillera Darwin represents a structural culmination, unique in the southern Andes, where pre-Late Jurassic basement rocks mainly of sedimentary origin, but now strongly deformed and regionally metamorphosed, are exposed. They are stratigraphically overlain by a cover of Upper Jurassic silicic-intermediate volcanic rocks (Tobifera Formation) and Lower Cretaceous clastic sedimentary rocks, occurring north and south of the main range. Basement and cover are cut by an early suite of granitic plutons (now gneisses) intersected by swarms of basic dikes (now amphibolites). Earlier work has shown that, during the Early Cretaceous, the area lay on the passive continental margin of an opening marginal basin of western Pacific type, i.e. in an extensional geotectonic environment. In the mid-Cretaceous this changed to compressional and the basin terrain (oceanic crust and thick flysch cover) became deformed and thrust against the continental margin to the north, which in turn suffered intense deformation and metamorphism. The effects of this "early Andean" orogeny are well documented in the Cordillera Darwin and are described in detail. Three phases of penetrative ductile deformation can be distinguished, all predating a second period of granite intrusion (isotopically dated at 80–90 my). Major fold structures developed during phases  $D_1$  and  $D_2$ , together with parasitic minor folds, extension and intersection lineations, and axial planar and transposition foliations in complicated patterns similar to those found in the deeper zones of the Alps and other collision-type orogens. Although the basement was completely remobilized, relict pre-Late Jurassic structures were found in places. During  $D_1$ – $D_2$ , metamorphic grades locally reached high amphibolite facies in basement and cover rocks alike. Tectonic evolution during this period shows an initial strong northward vergence ( $D_1$ ) changing through a complicated conjugate zonal geometry ( $D_2$ , with large recumbent south-facing folds in places) to a weak southward vergence ( $D_3$ ). Comparisons with the Central Alps and with the western North American Cordillera reveal some striking similarities but also significant differences in structural style and tectonic evolution.

### ZUSAMMENFASSUNG

Geologische Aufnahmen während zweier Kreuzfahrten des US-amerikanischen Forschungsschiffs *Hero* (1977, 1978) in den Fjorden und Kanälen von Süd-Feuerland (Chile) haben die Zusammenstellung der ersten detaillierten strukturgeologischen Karten der Region ermöglicht. Das Gebiet ist von der Cordillera Darwin, der südlichsten, E–W verlaufenden Hochgebirgskette der Anden, dominiert. Die Cordillera Darwin stellt eine Kulmination dar, wo als einzige Region in den südlichen Anden das präjurassische Grundgebirge über ein grösseres Gebiet aufgeschlossen ist. Dieses Grundgebirge besteht

---

<sup>1)</sup> Lamont-Doherty Geological Observatory contribution No. 3021.

<sup>2)</sup> Lamont-Doherty Geological Observatory of Columbia University, Palisades, New York 10964, USA.

<sup>3)</sup> Geologisches Institut, ETH-Zentrum, CH-8092 Zürich.

aus stark deformierten und metamorphen Para-Serien und wird von einer oberjurassischen bis unterkre-tazischen Bedeckung überlagert. Die Bedeckung ist im unteren Teil aus mächtigen sauren bis intermediären Vulkaniten (Tobifera-Formation), im oberen Teil aus klastischen Sedimenten aufgebaut, die heute in zwei Zonen nördlich und südlich der Hauptkette aufgeschlossen sind. Vor Beginn der Anden-Orogenese waren alle Serien zuerst durch eine Reihe von granitischen Plutonen und dann Scharen von basischen Gängen intrudiert. Während der Unterkreide befand sich das Gebiet am passiven Kontinentalrand eines Randbeckens, ähnlich den Randbecken im heutigen westliche Pazifik.

In der Mittleren Kreide wechselte das geotektonische Regime von krustaler Ausdehnung zu Kompression, wobei die Beckenunterlage (ozeanische Kruste und Flysch) gegen und über den im Norden liegenden Kontinentalrand geschoben wurde. Dieser (heute die Cordillera Darwin) wurde dabei stark deformiert, metamorphisiert und in ein Gebirge vom «Kollisionstypus» umgewandelt. Hauptge-wicht dieser Arbeit liegt bei der Beschreibung dieser – für die Anden sehr uncharakteristischen – Orogenese. Drei Phasen penetrativer duktiler Verformung  $D_1$ – $D_3$  können unterschieden werden, alle früher angelegt als eine zweite Generation von Granitplutonen mit radiometrischen Altern von 80 bis 90 Mio. Jahren. Grossräumige Strukturen (Überschiebungen, liegende Falten) entwickelten sich nur während der Phasen  $D_1$  und  $D_2$ , zusammen mit parasitären Kleinfalten, Lineationen und verschiedenen Schieferungstypen. Trotz dieser intensiven Überprägung bleiben stellenweise Anzeichen von noch früheren – präjurassischen – Strukturen im Grundgebirge erhalten. Während  $D_1$ – $D_2$  erreichte die Metamorphose in gewissen Gebieten obere Amphibolitfazies. Eine Rekonstruktion der tektonischen Entwicklung zeigt während  $D_1$  eine starke nordvergente Bewegung, während  $D_2$  eine komplizierte Kinematik in konjugierten Zonen und während  $D_3$  eine schwache südvergente Tendenz. Vergleiche mit den Zentralalpen und dem Westen von Nordamerika ergeben teils auffallende Ähnlichkeiten, teils auch bedeutende Unterschiede im strukturellen Stil und in der tektonischen Entwicklung.

### Introduction

The Cordillera Darwin is the highest part of the E–W trending Andean cordil-lera in Tierra del Fuego. It is situated in the southwestern part of Isla Grande de Tierra del Fuego, adjacent to the Argentine frontier (Fig. 1). The Cordillera Darwin has several peaks over 2000 m, notably Monte Darwin (2438 m) and Monte Shipton, the highest (2469 m). An extensive ice cap, which covers the high peaks, limits rock exposure and makes access on foot difficult. The region is also completely uninhab-ited, so traversing by boat along the almost continuously exposed walls of an extensive network of fjords is at present the most efficient way to study the geology. For comparison of size, the area of the Cordillera Darwin is approximately the same as that of the combined Valais and Bernese Alps in Switzerland.

The first scientific studies were made by Charles Darwin in the course of the voyage of H.M.S. *Beagle* in 1836. While travelling by open boat along the fjord now known as the Canal Beagle (Fig. 1), Darwin recorded many accurate observations concerning the basic lithology and structure of the rocks (DARWIN 1890). The first extensive study of the geology of the Cordillera Darwin was not made until 1929 when E.H. Kranck visited southern South America with a Finnish expedition. Shortly afterwards he published an outstanding monograph containing detailed accounts of many outcrops, land traverses, and field relations, as well as petrograph-ic descriptions (KRANCK 1932). Both DARWIN and KRANCK noted that the metamor-phic grade of many of the rocks in the Cordillera Darwin, which in places contain garnet and amphibole, is considerably higher than that encountered elsewhere in the southern Andes. KRANCK called these high grade rocks the “Central Schists” of the Cordillera Darwin. He also noted that granitic rocks, both deformed and undeformed, are common in the Cordillera.

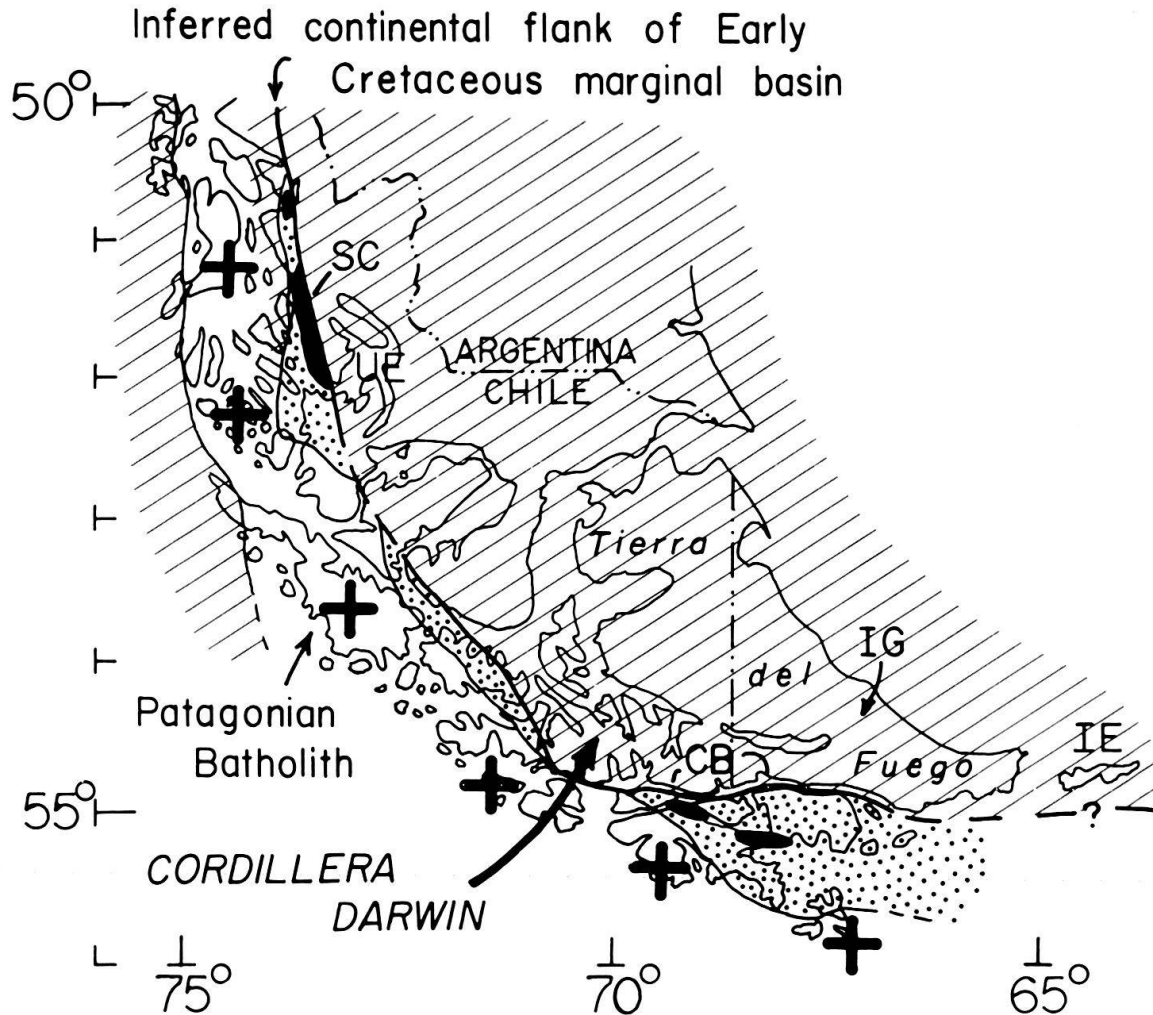

Fig. 1. Index map showing areas underlain by pre-Jurassic basement rocks (*lined*), early Cretaceous marginal basin rocks (*dotted*) with ophiolites (*black*), and the Patagonian Batholith. "Batholith" includes numerous individual plutons yielding radiometric ages between 150 and 10 my b.p. as well as some roof pendants of pre-Late Jurassic basement. UE=Ultima Esperanza area; SC=Sarmiento ophiolite complex; IE=Isla de los Estados; IG=Isla Grande de Tierra del Fuego; CB=Canal Beagle.

In the past twenty years reconnaissance studies have been undertaken by geologists from the Empresa Nacional del Petroleo and the Instituto de Investigaciones Geológicas of Chile, and also by scientists from various Australian, British, Japanese and United States institutions (DALZIEL & CORTÉS 1972; HALPERN 1973; KATZ 1973). In the course of two recent cruises with the United States National Science Foundation's Research Vessel *Hero*, we have spent a total of ten weeks studying the Cordillera Darwin (NELSON et al. 1977 and in press). We have mapped virtually all the coastlines with the exception of an area in the southwest restricted by the Chilean authorities. In addition we have made some inland traverses, and one of us (EPN) has spent several weeks making a detailed study of the inner part of Bahia Parry in the northeastern part of the Cordillera (Plate). The mapping, at a scale of 1:100,000 using base maps supplied by the Empresa Nacional del Petroleo, has resulted in preparation of the first relatively detailed geologic and structural maps and cross sections of the Cordillera Darwin.



The purpose of this paper is to give an account of the geologic structure and history of the Cordillera, to relate it to the tectonic setting of the southern Andes as a whole, and to comment briefly on the nature and significance of the overall tectonic style in comparison with other orogenic belts, notably the Central Alps and the cordillera of western North America.

### **Geologic and geotectonic setting**

The Cordillera Darwin is a structural culmination that exposes a large area of pre-Late Jurassic basement rocks. These rocks are almost entirely surrounded by younger Mesozoic volcanic and sedimentary rocks. A complex history of deformation and metamorphism and at least three episodes of igneous intrusion are recorded. These events reflect the interaction of lithospheric plates along the evolving Pacific continental margin of Gondwanaland and, later, of South America over the past 200–300 million years (Table). The following is a summary of the geologic history of events in the region in chronological order as they pertain to the evolution of the Cordillera Darwin.

#### *Late Paleozoic to Early Mesozoic*

The western portion of the basement complex south of 49° S latitude appears to represent an accretionary prism that was developed along a convergent segment of the Late Paleozoic to Early Mesozoic Pacific margin of Gondwanaland (BARKER, DALZIEL et al. 1976; DE WIT 1977; FORSYTHE 1978; DALZIEL & FORSYTHE 1978; FORSYTHE & MPODOZIS 1979). The presence of volcanic rocks in the basement terrain of the Cordillera Darwin indicate that this region was near the Late Paleozoic to Early Mesozoic arc. The basement complex throughout southern South America underwent at least one phase of deformation prior to uplift and erosion in the Triassic or Early Jurassic (DALZIEL & CORTÉS 1972; DALZIEL & ELLIOT 1973; FORSYTHE & MPODOZIS 1979).

#### *Mid-Mesozoic (Late Jurassic to Early Cretaceous)*

Following uplift and erosion of the basement complex, silicic to intermediate volcanism and plutonism occurred in the Late Jurassic throughout much of southern South America. This igneous activity was associated with widespread normal faulting and thus BRUHN et al. (1978) have compared the Late Jurassic tectonics of the region with the Cenozoic Basin and Range tectonics of western North America. However we believe that this comparison represents only one possible analogy, and that the origin of the Late Jurassic volcanism remains problematic. Jurassic isotopic ages in the Patagonian Batholith (Fig. 1.; HALPERN 1973) along the Pacific margin do, however, suggest subduction of Pacific ocean floor at this time.

In latest Jurassic and earliest Cretaceous time, a marginal basin of uncertain width developed within this volcanic terrain and separated an active calc-alkaline peninsular or insular arc to the west from the rest of the continent (KATZ 1973; DALZIEL et al. 1974a). The marginal basin was floored in part by oceanic crust and received detritus from the volcanic arc on the Pacific side and from the continent on

Table: Comparative chart of geologic events in the Cordillera Darwin and in the Scotia Arc region.

REGIONAL		CORDILLERA DARWIN	
	Lithology/Event	Interpretation	Interpretation
Cenozoic	Flysch-like and molasse-like sedimentation in foredeep; development of foreland fold and thrust belt; uplift of Cordillera; arc and back-arc magmatism; strike-slip faulting; glaciation.	Continuation of subduction; development and migration of Chile rise-Chile trench triple junction; development of South American-Scotian-Antarctic plate triple junction.	Continuation of subduction; development and migration of Chile rise-Chile trench triple junction; development of South American-Scotian-Antarctic plate triple junction.
Late Cretaceous	Widespread intrusion of calc-alkaline plutons; flysch-like sedimentation in foredeep.	Continuation of subduction.	Continuation of subduction with possible change in configuration of subduction zone.
mid-Cretaceous	Deformation of variable intensity and style in marginal basin and adjacent continental margin; inception of uplift of arc and marginal basin terrains; downward of Magallanes basin ("foredeep") in foreland.	Increase in convergence rate and/or change (flattening) in configuration of subduction zone.	Deformation and metamorphism of continental margin associated with uplift and destruction of marginal basin.
Early Cretaceous (see Fig. 1)	Calc-alkaline arc magmatism; back arc flysch-like sedimentation; black shale sedimentation to N & E on continental margin.	Infilling of marginal basin behind active arc and adjacent to shallow marine continental shelf.	Infilling of marginal basin in south changing to shelf sedimentation in north.
Late Jurassic	Localized extension and subsidence together with ophiolite emplacement within magmatic arc.	Inception of marginal basin; Pacificward shift of arc locus.	?Fringe of marginal basin ophiolitic complex to south.
Late Jurassic	Widespread normal faulting and siliceous volcanism; calc-alkaline magmatism along Pacific margin.	Regional extension and continuation (or resumption) of subduction, and anatexis of crust.	Anatexis of crust and subduction(?) related magmatism.
?Late Triassic to Middle or Late Jurassic	Uplift and erosion.	?Cessation of subduction or change in configuration of subduction zone.	?Cessation of subduction or change in configuration of subduction zone.
?Late Triassic or Early-Middle Jurassic	Pelagic, flysch-like and ophiolitic rocks Pacificward of calc-alkaline igneous rocks along craton margin.	Fore-arc and arc rocks related to subduction of Pacific ocean floor beneath Gondwanaland.	?Deformation related to subduction.
Late Paleozoic			?Arc and fore-arc rocks, cherts.

the Atlantic side (DALZIEL et al. 1975; WINN 1978). The southern edge of the Cordillera Darwin is a major crustal boundary (herein called the Canal Beagle line) separating the southernmost exposures of pre-Late Jurassic basement rocks from the northernmost exposures of Lower Cretaceous ophiolitic rocks that formed the basement of the marginal basin. Thus the present Cordillera Darwin lay at the passive continentward flank of the marginal basin during the Early Cretaceous.

#### *Late Mesozoic–Cenozoic*

During the mid-Cretaceous both the marginal basin and the adjacent continental margin were uplifted and deformed. This deformation is most intense along the continental flank of the marginal basin, decreases in intensity toward the magmatic arc, and is probably absent in the arc itself. Calc-alkaline plutons in the Patagonian batholith pacificward of the marginal basin terrain (Fig. 1) range in age from Late Jurassic to Neogene (HALPERN 1973) and probably indicate continuation of subduction throughout this time. Lack of systematic geochronology on the rocks of the batholith, however, precludes precise definition of this subduction in time and space.

Mid-Cretaceous deformation and uplift of the southern Andean cordillera was accompanied by the development of a foreland basin (or foredeep), known as the Magallanes basin, on the Atlantic side of the Cordillera (SCOTT 1966; URIEN & ZUMBRANO 1973; NATLAND et al. 1974). Coarse detritus derived from the uplifted terrain arrived in the Magallanes basin earlier in the north (Coniacian to Campanian in the Ultima Esperanza area) than in the south (Maestrichtian in the Tierra del Fuego area) (M.A. WINSLOW, pers. comm.). Deposition continued in the Magallanes basin throughout most of the Cenozoic. Deformation in the foreland occurred from Late Cretaceous through Neogene affecting progressively younger foreland sediments and migrating atlanticward from the Cordillera (WINSLOW, in press).

Beginning in the mid-Tertiary, the region south of 49° S latitude was dissected by left-lateral transcurrent faults. These faults appear to have developed to accommodate the complex Cenozoic to Recent evolution of plate boundaries in the Scotia Sea region (BARKER & GRIFFITHS 1972; FORSYTH 1975; HERRON et al. 1977).

Tertiary deformation on the Atlantic (foreland) side of the Andes has been classically referred to as “Andean” (GROEBER 1952). DALZIEL & CORTÉS (1972), however, used the term to refer to all the tectonic events occurring since mid-Cretaceous and related to the building of the present mountain chain. In keeping with this usage, the mid-Cretaceous deformation in the Cordillera Darwin will be referred to here as “early Andean”.

#### **General geology of the Cordillera Darwin**

A general description of the geology of the area based on our recent mapping will be given first. The deformation associated with closure of the marginal basin will then be analyzed in more detail. Finally an interpretation of the tectonic evolution of the region will be presented.

A major unconformity separates an Upper Jurassic and younger volcanic and sedimentary cover sequence from an older basement terrain. This unconformity has

been recognized elsewhere in the Andes south of 49°S latitude and is also exposed in the Cordillera Darwin (KRANCK 1932; CESPEDES, unpubl. report of the Empresa Nacional del Petroleo; DALZIEL et al. 1970; DALZIEL & ELLIOT 1971, 1973). A major problem in the Cordillera Darwin has been the distinction between basement and cover rocks because of their similar lithologies, and because both have been strongly affected by various periods of Andean deformation and metamorphism. Nonetheless, in the northern slopes of the Cordillera Darwin, we have been able to recognize the basement-cover contact as a clear unconformity at four localities. The contact along the southern edge of the Cordillera can be distinguished only on the basis of lithologic correlation because the degree of deformation and metamorphism is more intense here than in the north.

In addition to the variably metamorphosed basement and cover terrains, two felsic plutonic suites and a suite of mafic dikes are exposed in the Cordillera Darwin.

#### *Basement complex (rock unit 1, see Plate)*

The basement complex is exposed only in the central portions of the Cordillera, and is completely surrounded by cover rocks (Plate). The basement lithology is predominantly graphitic phyllite and schist. These rocks are gneissic and occasionally migmatitic where local metamorphic grade attains amphibolite facies. The predominantly pelitic rocks contain variable concentrations of silicic layers a few millimeters to a few centimeters thick. The silicic layers are of two types: a) metasiltstone and metatuff and b) irregular pods and lenses of vein-type quartz of secondary origin. The prominence of secondary quartz veins in the basement complex and their absence in the cover complex helps distinguish the two complexes.

The basement complex also includes lesser but significant amounts of quartzitic schist and greenstone, probably representing quartz sandstone or chert and intermediate or basaltic volcanic protoliths respectively. A preliminary Rb/Sr whole rock isochron on pelitic and quartzitic schists from Bahia Plüschow (Plate) gives a minimum age of  $224 \pm 38$  my for the basement complex (HERVÉ et al., in prep.).

The volcanic horizons suggest that the original sediments of the basement complex were probably deposited near a magmatic arc. The lithologies present in the basement complex are similar to those in other pre-Jurassic basement terrains in southern South America. Taken together these basement terrains can be interpreted as representing part of the Late Paleozoic to Early Mesozoic Pacific margin of Gondwanaland (DU TOIT 1937; DALZIEL, in press).

#### *Cover complex (rock units 3 and 5, see Plate)*

The cover complex consists of a predominantly volcanic sequence overlain by a clastic sedimentary sequence. The predominantly volcanic unit is generally referred to as the Tobifera Formation in English literature (THOMAS 1949; see DALZIEL et al. 1974b and WINSLOW 1980 for discussion). It is extensively present in outcrops and in the subsurface in the Tierra del Fuego region (NATLAND et al. 1974, Fig. 25). The clastic sedimentary sequence in the Cordillera Darwin was originally named the Monte Buckland Series for exposures along Seno Keats in the north (Plate), and the

Yahgan Formation for exposures just south of the Cordillera (KRANCK 1932). There is considerable variation in thickness of the cover sequence both along and across generally E-W regional lithologic trends. The cover rocks from northern and southern exposures in the Cordillera are described separately because the lithologies and the degree of deformation and metamorphism are most variable transverse to the range.

*Northern cover rocks:* There are two main cover units on the northern side of the Cordillera Darwin. The lower unit consists of dominantly silicic volcanic rocks usually characterized by a thin sedimentary sequence near the base. This sedimentary sequence usually includes a basal conglomerate horizon which varies from a diamictite to a very coarse, clast-supported conglomerate. The conglomerate clasts are predominantly volcanic, but some basement components (with clear deformational fabrics) are intermixed in places. The main part of the volcanic unit is highly variable and consists of well-bedded tuff, flow-banded rhyolite, massive rhyolite, very coarse volcanic (vent?) breccia, and scoriaceous flows. Fine-grained to very coarse-grained clastic intercalations are occasionally found. The lithology is very similar to that found on Isla de los Estados along strike to the east (DALZIEL et al. 1974b, see Fig. 1).

The upper cover unit is comprised of fine to coarse-grained clastic sedimentary rocks with a high component of volcanic detritus. The contact between the upper and lower units was conformable where it was observed. Metamorphic grade in the northern cover nowhere exceeds lower to middle greenschist facies.

*Southern cover rocks:* The southern cover rocks contain a greater proportion of intermediate volcanic rocks than the northern cover rocks. These volcanic rocks, now greenschists, are interlayered with a silicic volcanic unit, and occur mainly in a zone separating the silicic unit and a clastic sedimentary unit (see Plate). The greenschists are strongly deformed and volcanic breccias and occasional pillow structures are the only primary textures preserved. These greenschists were previously interpreted as part of the ophiolitic complex of the marginal basin terrain (KATZ 1973; DALZIEL et al. 1974a). However the intermediate, rather than tholeiitic, appearance of these rocks belies an ophiolitic association. As an alternative, we suggest that the greenschists in the southern cover sequence could be subduction-related calc-alkaline volcanic rocks, as suggested for similar rocks farther east by BRUHN et al. (1978). Some contribution of more basic magmas related to tholeiitic volcanism in the marginal basin cannot be ruled out.

The clastic sedimentary sequence in the southern cover is lithologically similar to that in the north, except for exhibiting a generally higher metamorphic grade (up to amphibolite facies in places) and stronger deformation.

#### *Intrusive rocks*

KRANCK (1932) recognized two distinct felsic plutonic suites in the Cordillera Darwin. A third intrusive suite, consisting of a swarm (or swarms) of mafic dikes, intrudes the older of the two felsic suites and the basement complex, and is itself intruded by the younger felsic suite. Because the older felsic suite and the mafic dikes are both deformed whereas the younger felsic suite is undeformed, the



relationship of these three suites to other rocks helps constrain the timing of deformational events in the Cordillera.

*Deformed plutonic suite (rock unit 2, see Plate):* Felsic orthogneisses are exposed in the central and southern portions of the Cordillera, and are usually surrounded by basement rocks of medium to high metamorphic grade. The country rocks intruded near the mouth of Seno Ventisquero, however, are possibly part of the cover sequence (see Plate).

The orthogneisses consist of biotite granites and granodiorites (modal quartz > 20%). Minor phases consist of garnet and occasionally muscovite and amphibole. Myrmekite and accessory allanite are common in these rocks. The gneisses are weakly foliated to nearly mylonitic. The plane of foliation is defined by parallel alignment of micas and, in more strongly deformed rocks, by the dimensional preferred orientation of flattened feldspar and quartz grains.

The orthogneisses have yielded an Rb/Sr whole rock isochron date of  $157 \pm 7$  my and an initial  $^{87}\text{Sr}/^{86}\text{Sr}$  ratio of  $0.70875 \pm 0.0019$  ( $2\sigma$ ) (HERVÉ et al., in prep.). The Middle to Late Jurassic isotopic date on these plutons is consistent with the interpretation that they are the subvolcanic, plutonic equivalents of the volcanic rocks of the Upper Jurassic Tobifera Formation in the cover complex. The silicic (and probably peraluminous) nature of the orthogneisses together with their high initial  $^{87}\text{Sr}/^{86}\text{Sr}$  ratios are compatible with an origin either by crustal anatexis (CHAPPELL & WHITE 1974) or by crustal contamination.

*Mafic dike swarm:* The characteristic sheeted appearance of the orthogneiss bodies is produced by the alternation of gneiss and abundant mafic dikes. The dikes are concentrated in the central and southern portions of the Cordillera and are characteristically regularly spaced sheets 1–4 m thick. Although apparently concentrated within the orthogneisses (only one gneiss body, at Bahia Plüschow, seemed to lack dikes), similar mafic sheets were also observed in the basement complex, where they are generally concordant to compositional layering.

The basaltic dikes are now amphibolites composed of 60–80% amphibole, 20–40% plagioclase, with minor amounts of biotite, opaque oxides, sphene, and garnet. The foliation of these rocks is defined by the preferred orientation of amphibole and plagioclase, and is usually, but not always, parallel to the dike margins.

The dikes were intruded after the Upper Jurassic granitic rocks (orthogneiss complex) and before the mid-Cretaceous deformation recorded in the Cordillera Darwin. The dikes may have been intruded during an episode of crustal extension linked to the formation of the marginal basin. Alternatively, the mafic dikes could represent mafic magmas that were cogenetic with the orthogneiss complex as evidenced by their close association with it, or even as feeders, associated with the intermediate volcanics present in the southern cover complex. More petrologic and geochemical data are needed to distinguish between these hypotheses.

*Undeformed plutonic suite (rock unit 6, see Plate):* Undeformed plutonic rocks are restricted to the central and southern portions of the Cordillera Darwin. The rocks are biotite or occasionally hornblende tonalites and granodiorites, commonly with minor muscovite. Isotopic whole rock and mineral ages from various plutons from within this suite indicate that they range in age (minimum) from about 70 to 90 my



old (HALPERN 1973, p. 2416). As the plutons discordantly intrude all formations and  $D_1$ - $D_2$  structures (see below), their age indicates that the main deformation in the Cordillera Darwin occurred in the mid-Cretaceous (see DALZIEL & PALMER 1979).

Undeformed plutons were not observed intruding  $D_3$  structures, although a few plutonic rocks of probable Late Cretaceous age along the Canal Beagle have  $D_3$  or younger deformation fabrics.

### Structural geometry and sequence

Four generations of structures have been recognized in the Cordillera Darwin. These are designated  $D_B$ ,  $D_1$ ,  $D_2$  and  $D_3$  in order of decreasing age. The earliest ( $D_B$  or pre-Andean) structures are restricted to basement rocks and the younger three ( $D_1$ ,  $D_2$  and  $D_3$  or early Andean) are found in both basement and cover rocks. The early Andean structures are more strongly developed in the south than in the north and hence the basement structures ( $D_B$ ) are best preserved in the north.

Distinction and correlation of structural fabrics is based on contrasts in structural style and orientation, as well as their relative structural age. Structural style is generally distinctive for a given phase, but can change with lithology or can vary because of local conditions accompanying deformation. It is also possible that the absolute timing of structural phases varies along or across regional structural trends even though the relative age of structural events remains the same at any given locality.



Fig. 2.  $D_1$  folding of amphibolite sheet (originally a mafic dike) with axial plane foliation ( $S_1$ ) visible in granitic gneiss: northern Bahia Pia (lens cap for scale).



a

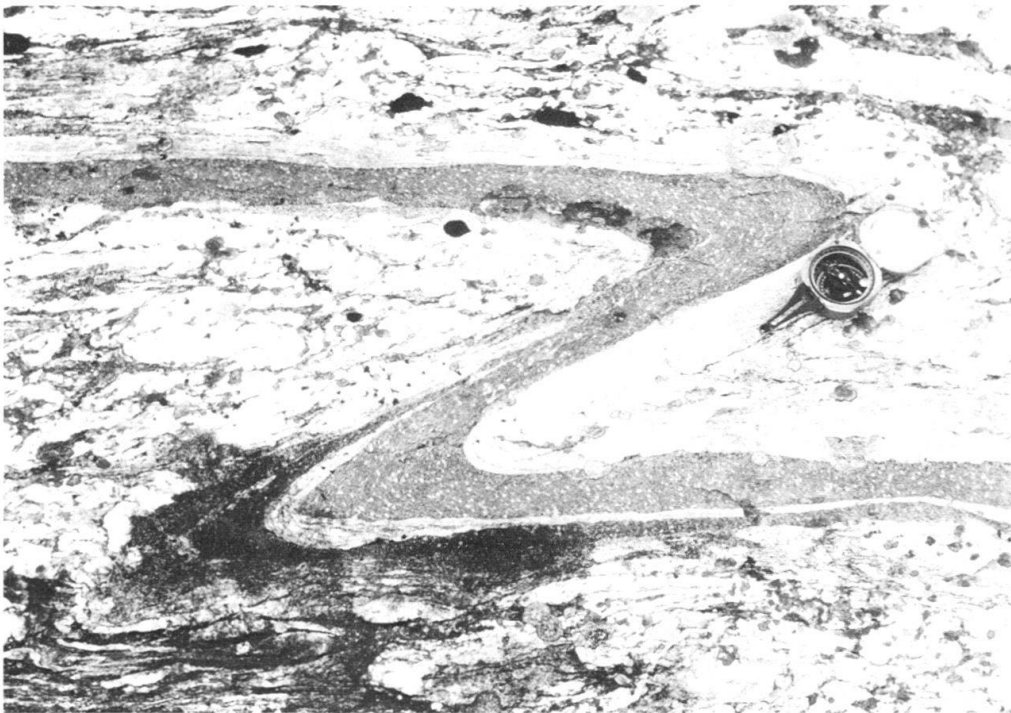

b

Fig. 3.  $D_2$  structures. a)  $S_2$  crenulation cleavage in basement phyllite; Seno Agostini. b)  $D_2$  fold in garnet-bearing amphibolite (originally a mafic dike) within a granitic gneiss (note shape of garnets in hinge zone); Bahia Pia.

*D<sub>B</sub> structures:* Pre-Late Jurassic structures have previously been recognized elsewhere in the southern Andean Cordillera (KRANCK 1932; FERUGLIO 1949; DALZIEL 1970; DALZIEL & CORTÉS 1972; FORSYTHE & ALLEN, in press). In the Cordillera Darwin intense, pervasive, early Andean deformation and metamorphism have almost completely obscured any pre-existing (*D<sub>B</sub>*) fabric in the basement rocks. Rare pre-*D<sub>1</sub>* isoclinal folding of compositional layering (bedding?) and pre-*D<sub>1</sub>* secondary vein-like quartz layers are the only remaining evidence of this earlier basement deformation and metamorphism, except for the pre-depositional structures in components of the basal cover conglomerate mentioned above.

*D<sub>1</sub> structures:* The first phase of early Andean structures is characterized by a strongly developed foliation (*S<sub>1</sub>*). *S<sub>1</sub>* varies markedly in character from south to north; it is generally schistose and locally mylonitic in the southern cover rocks, but in contrast, it is a slaty cleavage in the northern cover rocks. In the south the foliation is subparallel to compositional layering and axial planar to isoclinal folds. In the north the foliation is usually at a high angle to bedding and is axial planar to open mesoscopic and macroscopic folds.

*S<sub>1</sub>* in the basement, usually consists of a phyllitic or schistose foliation in pelitic lithologies, and in places it is a layering produced by quartz veins that are axial planar to tight and isoclinal folds in more siliceous rocks. In the orthogneiss complex and associated mafic dikes, *S<sub>1</sub>* is generally characterized by the mesoscopic alignment of fine-grained micas and coarse-grained feldspars and amphiboles. It is usually parallel to the contacts of the mafic dikes but in places cuts across them, indicating the presence of mesoscopic and macroscopic *D<sub>1</sub>* folds (see Fig. 2 and Plate, section EE').

A pervasive lineation (*L<sub>1</sub>*) is commonly associated with *S<sub>1</sub>* in both basement rocks, cover rocks, and deformed intrusive rocks. This lineation is usually an elongation lineation defined by the parallel alignment of mineral grains, but in places it is also an intersection lineation formed by the intersection of *S<sub>1</sub>* and pre-*S<sub>1</sub>* surfaces. Small scale *D<sub>1</sub>* intrafolial fold hinges often parallel *L<sub>1</sub>*, which, although reoriented somewhat by *D<sub>2</sub>* and *D<sub>3</sub>*, is usually at a high angle to regional lithologic trends (compare Fig. 1 and Fig. 7).

*D<sub>2</sub> structures:* *D<sub>2</sub>* structures, like *D<sub>1</sub>* structures are generally more penetrative in the southern portion of the Cordillera Darwin. In the south-central portion of the Cordillera macroscopic, tight, recumbent or near recumbent south-facing and south-verging *D<sub>2</sub>* structures fold *D<sub>1</sub>* structures (see Plate, section CC'). Associated with these nappe-like folds are tight to isoclinal, asymmetric parasitic folds. The parasitic folds exhibit an axial planar crenulation cleavage (*S<sub>2</sub>*), and an intersection or crenulation lineation (*L<sub>2</sub>*) that is subparallel to major *D<sub>2</sub>* fold hinges. In areas of higher metamorphic grade, amphibole up to 1 cm long has grown subparallel to *D<sub>2</sub>* axial planes and sometimes subparallel to *L<sub>2</sub>*.

Within the southern basement complex, *S<sub>2</sub>* is characterized by a crenulation or strain-slip cleavage (Fig. 3a). In some places this cleavage completely overprints *S<sub>1</sub>* (Fig. 4). In the northern part of the basement complex, *S<sub>2</sub>* intersects *S<sub>1</sub>* at a low angle forming an anastomosing phyllitic cleavage similar to shear fracture cleavages (SF-tectonite fabrics, RAYMOND 1975). The main foliation along the north side of the Cordillera is thus a combined *S<sub>1</sub>/S<sub>2</sub>* structure.

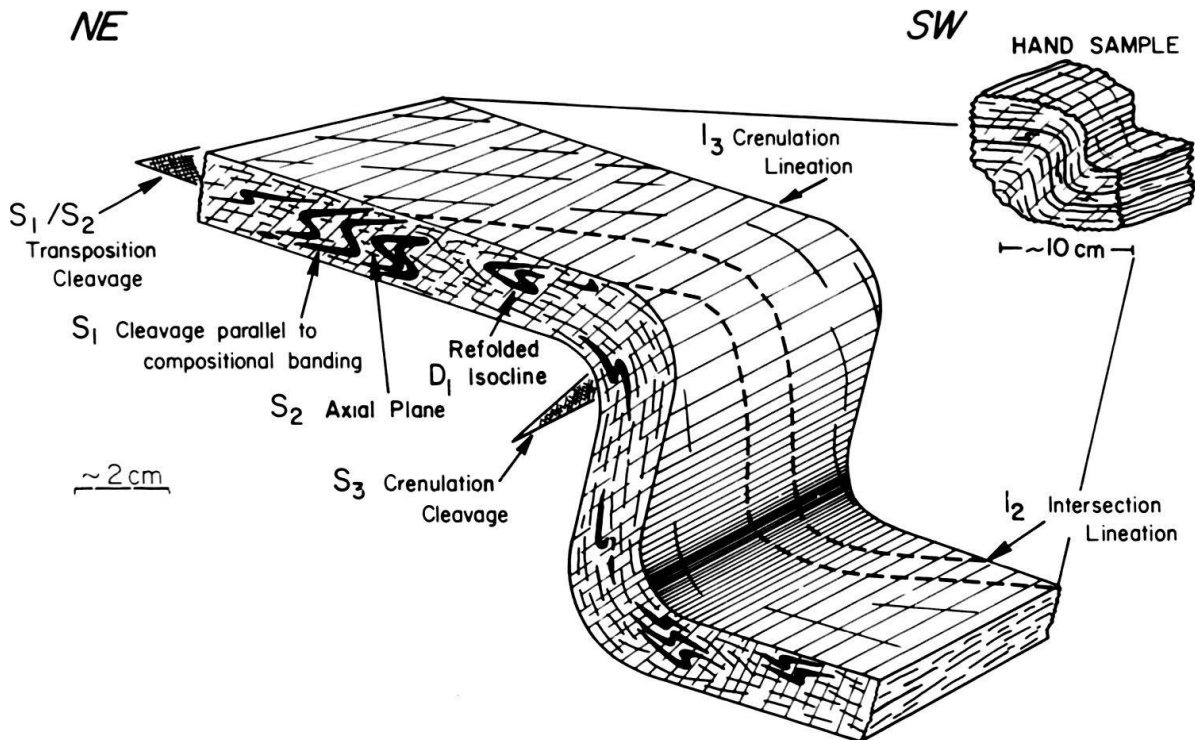

Fig. 4. Sketch of  $D_3$  fold in basement phyllite showing fabric elements of all three early Andean deformation phases: Seno Contralmirante Martinez.

The interlayered orthogneiss–mafic sheet masses show mesoscopic folds of this generation in the central and southern portion of the Cordillera (Fig. 3b). One steeply plunging macroscopic  $D_2$  fold was observed in Bahia Pia (Plate, section FF'), and can be traced for approximately 15 km to the north shore of the Canal Beagle.

**$D_3$  structures:** Third phase early Andean structures were recognized mainly in basement rocks, being less well developed in cover rocks. These structures consist of open crenulation style folds with axial planes that dip consistently northeast, with locally a crenulation cleavage  $S_3$ , and subhorizontal fold hinges. These structures are developed in a distinct zone in the west central portion of the Cordillera (Fig. 7). In the southern areas,  $D_3$  structures are not easily separated from  $D_2$  structures because of the near parallelism of  $S_3$  and  $S_2$  or of  $S_3$  and the axial planes of  $D_2$  folds (compare  $S_1/S_2$  in the north).

As mentioned above some  $D_3$ (?) or younger fabrics were observed in plutonic rocks along the Canal Beagle. Also, there is stratigraphic evidence of post-Cretaceous deformation in the foreland adjacent to the Cordillera Darwin (WINSLOW, in press). Thus it is possible that post- $D_3$  deformation could have affected the Cordillera Darwin and that these fabrics could be younger in the north than in the south.

**Faulting:** KRANCK (1932) and KATZ (1973) envisioned major north-vergent, south-dipping thrust faults along the northern margin of the Cordillera that juxtaposed basement rocks over cover rocks. We found no conclusive evidence for major thrust faults in the northern Cordillera, but we do believe that major northward tectonic transport of basement has occurred as evidenced by overturned ( $D_1/D_2$ )



folding of the cover with concomitant shearing and shortening in the basement (Plate, sections AA', DD', FF' and Fig. 8). This is suggested by the SF-tectonite fabric ( $S_1/S_2$ ) and regionally pervasive elongation lineation ( $L_1$ ) present in the northern basement rocks. This does not preclude the possible existence of early Andean thrust faulting further north, because our observations relate only to the southernmost margin of the foreland. Also the basement-cover contact is coincident with, or cut by major lineaments parallel to, transcurrent faults active in Late Cenozoic time (HERRON et al. 1977). The lineaments could represent old thrust faults reactivated during the Late Cenozoic, another structural style recognized within the foreland (WINSLOW, in press).

In the southern part of the Cordillera Darwin, south-directed thrust faulting appears to have been associated with major south-facing  $D_2$  folds (Plate, sections BB', CC'). Mylonitic  $S_1$  foliations in the southern cover rocks possibly indicate major regional simple shear during  $D_1$ , but kinematic analysis is hindered due to reorientation of  $D_1$  structures by later folding.

Transverse, post- $D_2$  high angle faults (see Plate) have offset, sheared, and reoriented earlier structural trends in places (for example along Seno Martinez and possibly along Bahia Yendegaia). Longitudinal high angle faults also effect earlier structures, but these may have had a longer and more significant history (see discussion of the Canal Beagle line below).

### Structural analysis and interpretation

As mentioned above, the Cordillera Darwin is a structural culmination that is unique in the southern Andes. It exposes deeper crustal levels in its central portions and thus records localized uplift since the mid-Cretaceous. This uplift is documented by the deposition of schistose and granitic detritus derived from the Cordillera in the foreland basin beginning in the Late Cretaceous (FERUGLIO 1949; KATZ 1964). The uplift may in part be the result of an important orogenic episode involving considerable crustal shortening and thickening due to the three local phases ( $D_1$  to  $D_3$ ) of early Andean deformation. Such a process has been documented along strike to the east on Isla de los Estados (Fig. 1; DALZIEL & PALMER 1979). Further uplift probably occurred on faults bounding the Cordillera to the north and south, although the precise time of movement of these faults is unknown. The history of Cenozoic uplift is still obscure.

The structural data in the Cordillera Darwin have been separated into fabric domains within which mesoscopic structures are traceable and statistically homogeneous in orientation throughout the domain. Figure 5 presents orientation data from domains where each set of structures is best developed. Figure 6 summarizes visual means of point maxima of this data. The degree of homogeneity of structures of each phase is variable for different domains depending on the amount of reorientation by younger phases of deformation. Analysis of orientation data and structural cross sections leads to an interpretation of the kinematic history of the early Andean deformation in this area (Fig. 8).

Strains associated with  $D_1$  structures are greatest in the south and decrease in intensity to the north. Where  $S_1$  is not transposed or reoriented by later deforma-

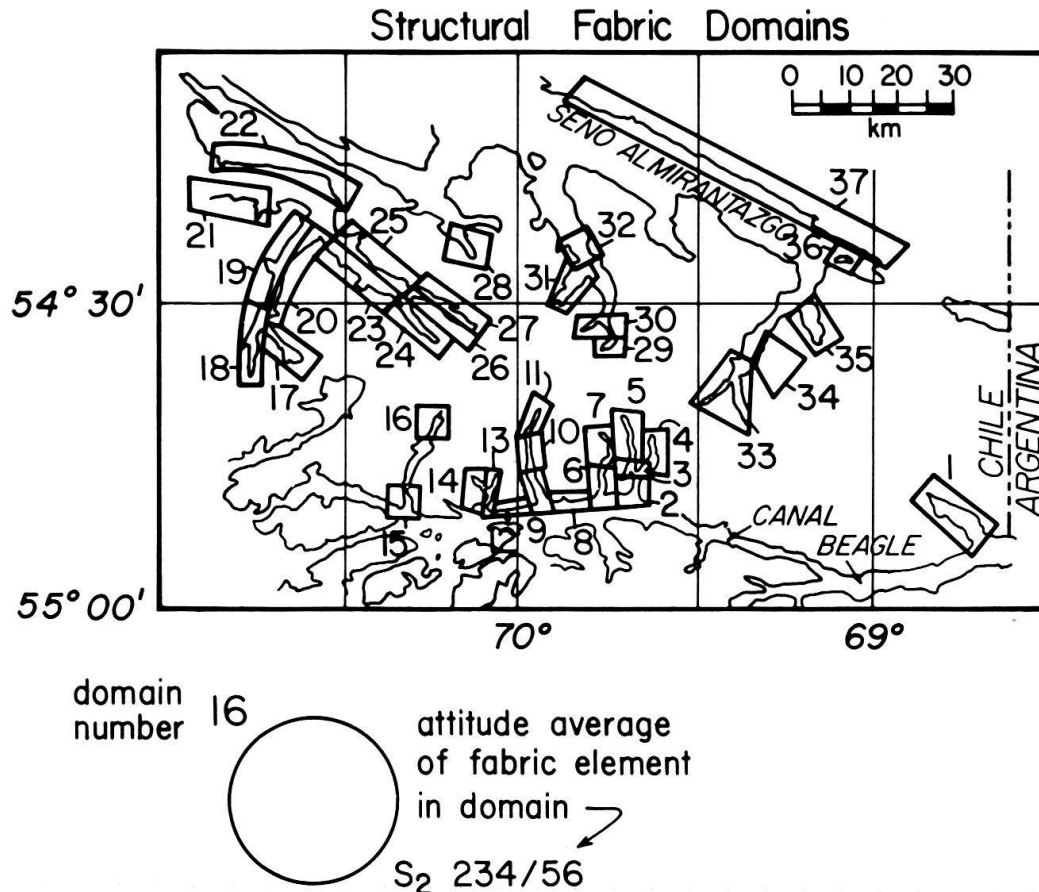

Fig. 5a. Mesoscopic fabric data from the Cordillera Darwin. Fabric domains: southern domains 1-16, northern domains 17-37 (for stereograms, see Fig. 5b-d).

tional phases it dips predominantly south or southwest and commonly contains a down-dip mineral elongation lineation (Fig. 5).  $D_2$  phase strains are also greater in the south than in the north, and display a conjugate geometry of  $D_2$  fold axial surfaces and foliations (Plate, sections CC', DD'). Figure 5 shows that  $S_2$  foliations and  $D_2$  axial planes dip north or northeast in the southern domains and south or southwest in the northern domains. Central domains generally have steeper to subvertical  $D_1$  and  $D_2$  structures (Plate).  $D_3$  strains are weakest and have affected a more restricted area than earlier phases (Fig. 7).  $D_3$  axial planes and crenulation cleavages have a very consistent northwest strike and northeast dip (Plate) which approximately coincides with the attitude of  $S_2$  in some southern areas.

Figure 8 illustrates a tectonic interpretation of the three phases of early Andean deformation. A generally northward vergence during the  $D_1$  phase, with strain intensity increasing southward, is consistent with BRUHN's (1979) "main phase" deformation immediately to the east in Argentina and also with the  $D_1$  and  $D_2$  phases of DALZIEL & PALMER (1979) still farther to the east on Isla de los Estados. BRUHN interpreted his main phase as the beginning of obduction of the marginal basin onto the continental margin. Generally this phase probably resulted in uplift and relative northward translation of the marginal basin terrain with respect to the stable craton, with strain concentrated near the boundary with, or in, the continental



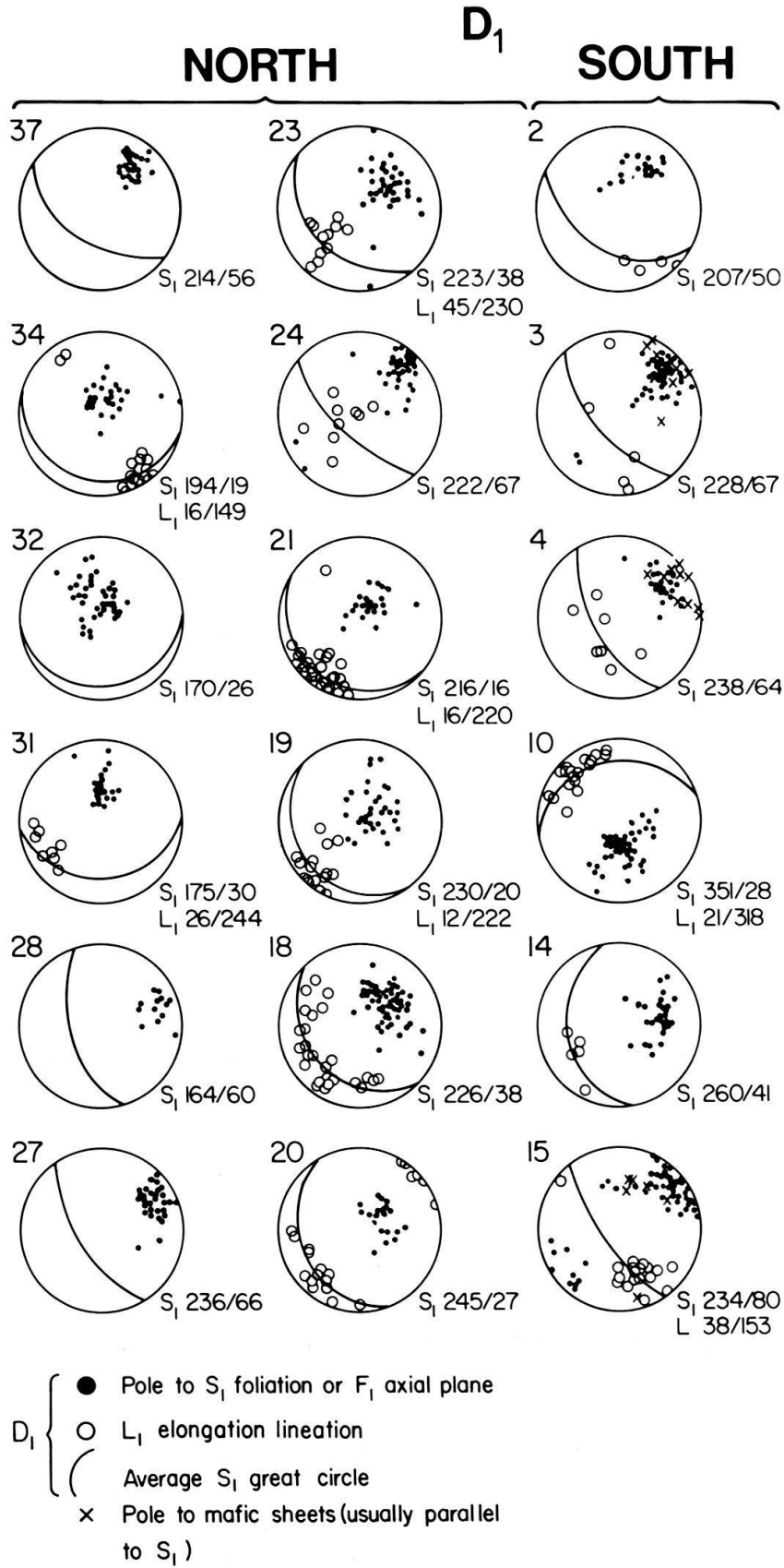

Fig. 5b. Mesoscopic fabric data from the Cordillera Darwin. First phase structures.

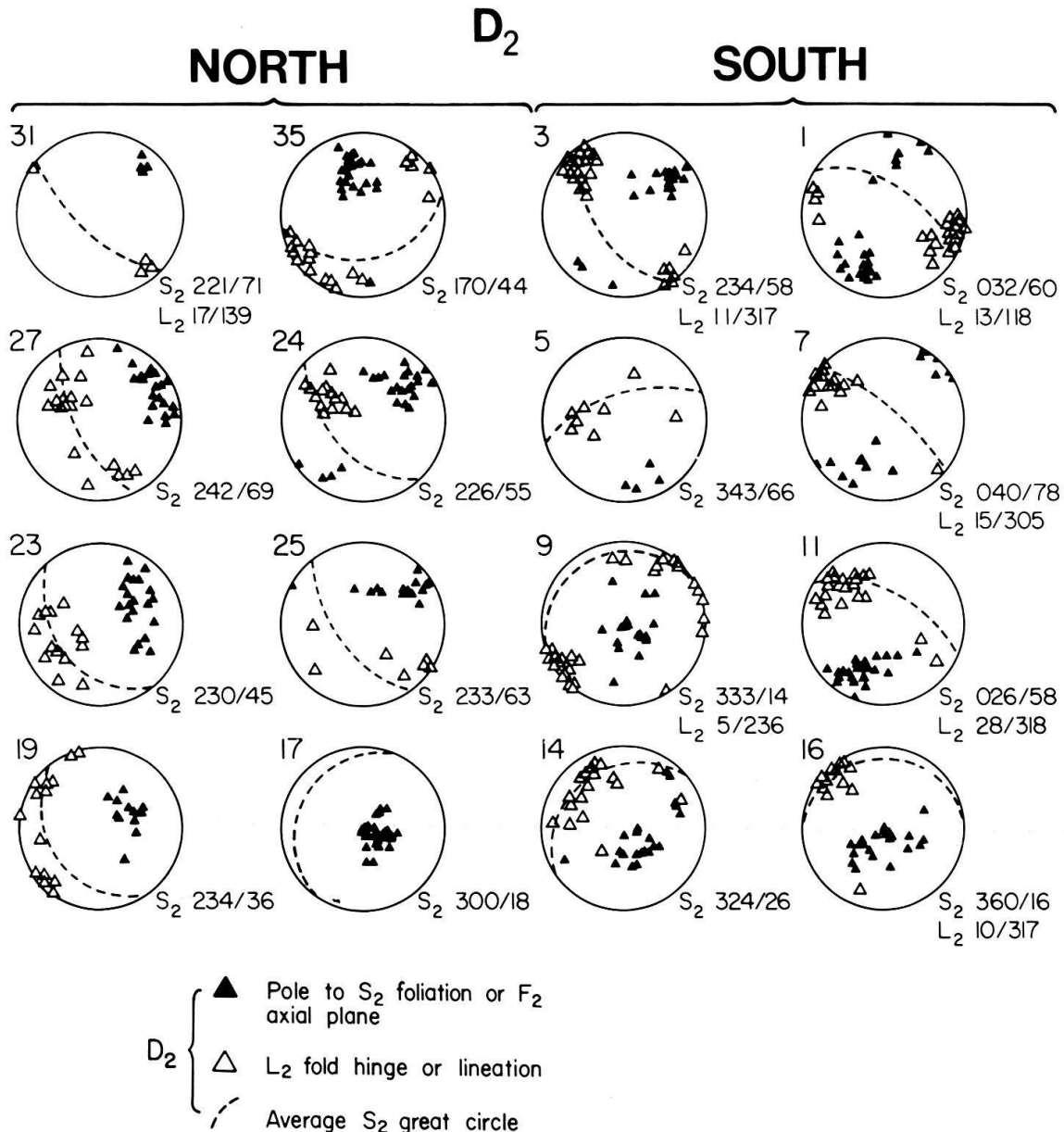

Fig. 5c. Mesoscopic fabric data from the Cordillera Darwin. Second phase structures.

margin. In most domains the  $L_1$  elongation lineation was usually down-dip within  $S_1$  and at a high angle to regional geologic trends (Fig. 7). We cautiously suggest that this lineation can be related to the direction of tectonic transport when regional tectonics are considered.

Large scale  $D_2$  folding resulted in refolding of  $D_1$  structures in the south and a parallelism of  $D_1$  and  $D_2$  structures in the north (Fig. 8). This fan-like or conjugate geometry possibly resulted in some uplift of the Cordillera Darwin relative to both the foreland region and the marginal basin, although the rocks now exposed were clearly quite deep during the  $D_2$  phase. Garnet-staurolite grade metamorphism, in part synchronous with the  $D_2$  phase, indicates that the central portion of the Cordillera was at depths of 10–20 km during this phase (GANGULY 1972).

A southward vergence of folds during the  $D_3$  phase indicates continued compression at a late stage, resulting in uplift of the craton relative to the deformed marginal basin terrain. This was probably related to movement along a zone following the Canal Beagle (the Canal Beagle line) as indicated by structural and metamorphic features discussed below.

A pattern of strain broadly similar to that in the Cordillera Darwin has been reported in the Porcupine Creek fan structure of the southern Canadian Rockies by PRICE & GARDNER (1979). In both cases the reversal of regional vergence may be in part related to a buttressing effect by the adjacent craton.

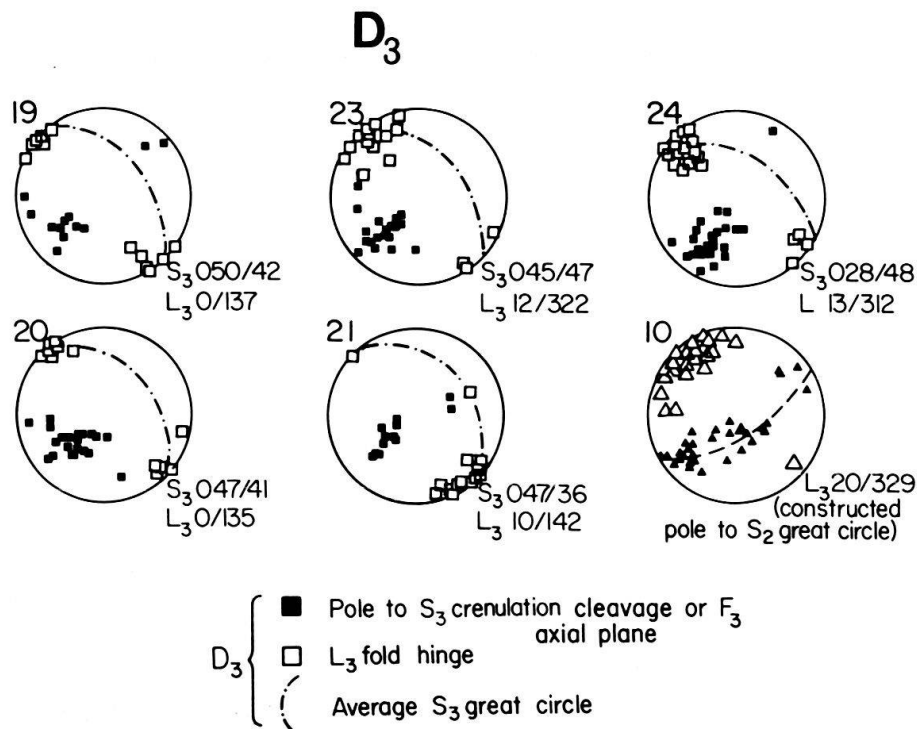

Fig. 5d. Mesoscopic fabric data from the Cordillera Darwin. Third phase structures.

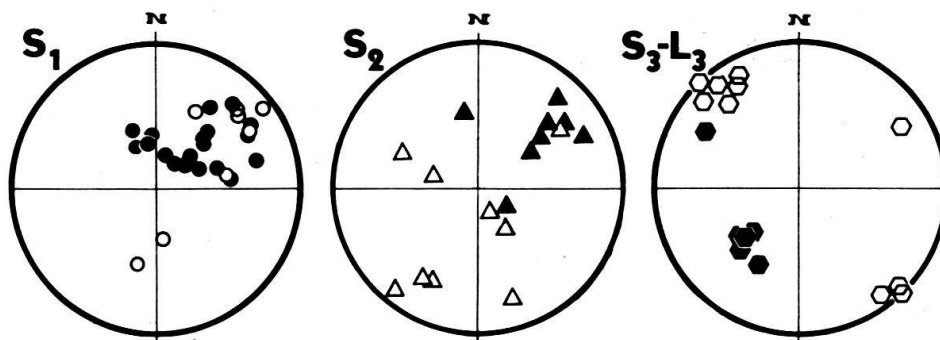

Fig. 6. Summary of fabric data from Figure 5. Symbols represent attitude averages (visual estimates) of point maxima of poles to foliation ( $S_1$ =circles,  $S_2$ =triangles,  $S_3$ =closed hexagons) and of lineation  $L_3$  (open hexagons). For  $S_1$  and  $S_2$ , closed symbols represent northern domains, open symbols represent southern domains. In the stereogram for  $S_3$ - $L_3$ , the one symbol plotting away from the rest represents the domain in which rotation of  $D_3$  fabrics along a younger fault has occurred.

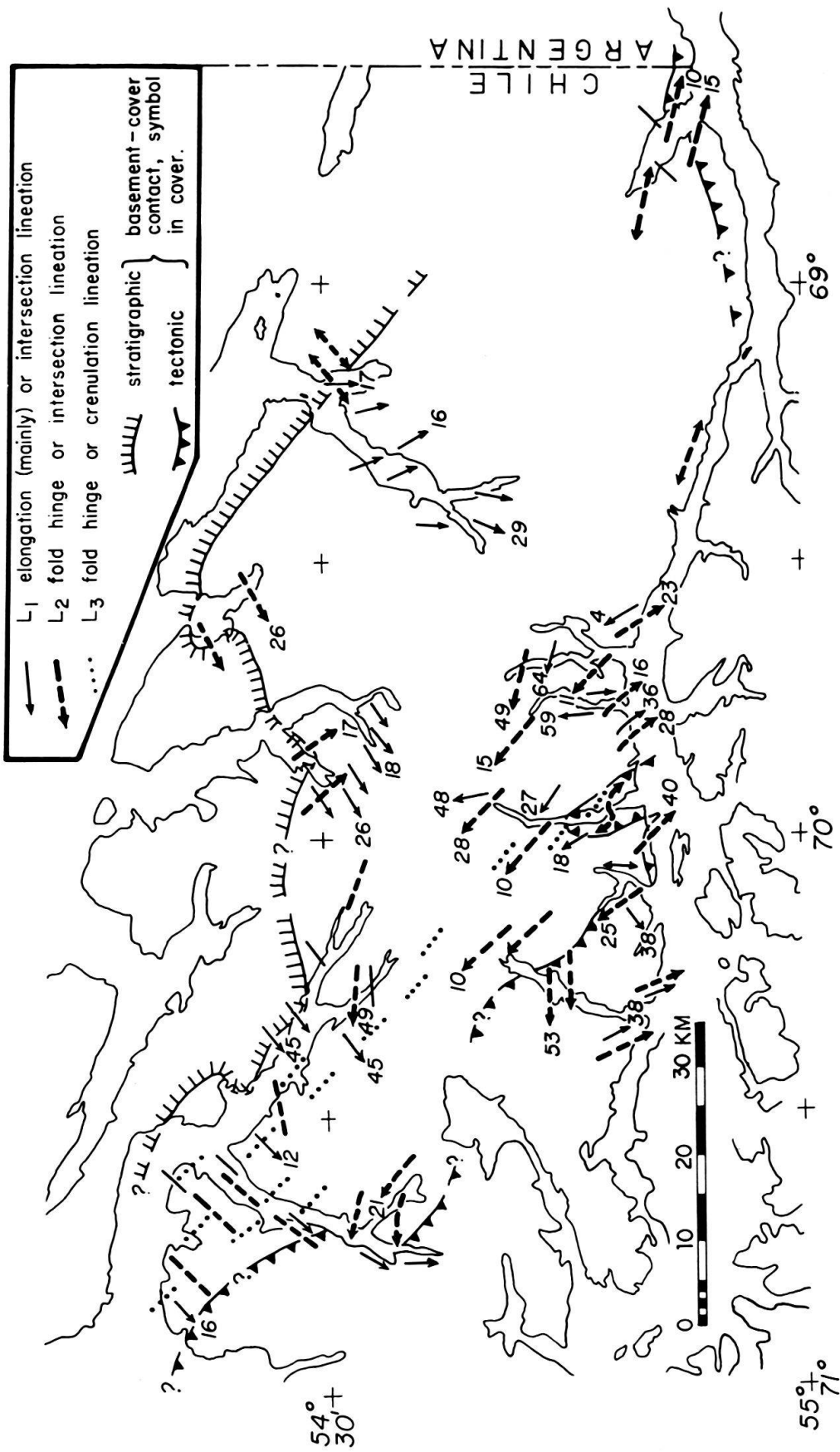

Fig. 7. Lineation trend map of the Cordillera Darwin. Arrows indicate direction of plunge of lineations where relevant.

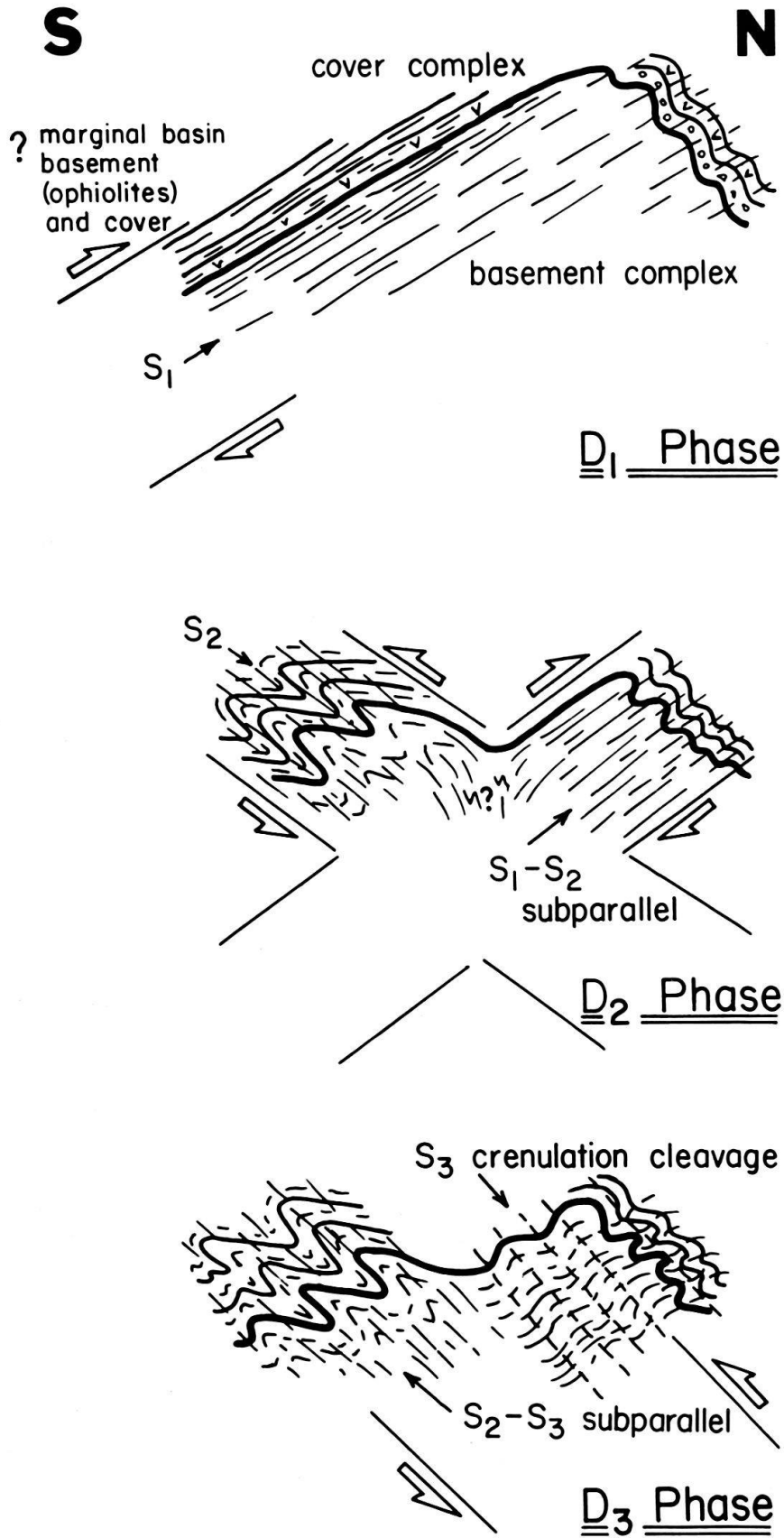

Fig. 8. Tectonic interpretation of the three phases of early Andean deformation in the Cordillera Darwin: diagrammatic cross sections of the mountain range at different stages.

The Canal Beagle forms the southern boundary of the Cordillera Darwin, here called the Canal Beagle line, and obscures a zone of long-lived crustal weakness and a major boundary separating different crustal types. It follows the present northern margin of the marginal basin terrain (based on crustal type), separating the southernmost exposures of *in situ* continental basement from the northernmost exposures of ophiolitic marginal basin crust. Thus the Canal Beagle line probably represents a zone along which major normal faulting and rifting occurred during the Early Cretaceous extensional formation of the marginal basin. Subsequently, during and after the early Andean deformation (particularly  $D_1$  and  $D_2$  phases), strain was concentrated along this same junction between marginal basin (partly ophiolitic) and continental crust. This is evidenced by the variation in intensity of strain within the Cordillera, and the close juxtaposition of schists with amphibolite grade ( $D_1$  to  $D_2$ ) mineralogy to the north against greenschist and lower grade rocks across the Canal to the south. Also,  $D_1$  and  $D_2$  structures are warped downwards into the Canal Beagle zone, indicating strong post- $D_2$  (? $D_3$ ) movement along the line (Plate). Post- $D_2$  uplift of the Cordillera relative to the marginal basin terrain has occurred, representing a reversal of relative movement along this zone. Reactivation of this fundamental boundary during Cenozoic time is also likely, although the evidence for this is equivocal. The Canal Beagle line is subparallel to major faults along which post-Miocene movement has been documented in Tierra del Fuego (HERRON et al. 1977). The Canal Beagle line also marks the southern edge of a present-day high mountain range, possibly indicating significant Quaternary differential movement (? glacial rebound).

### Discussion

Because the Cordillera Darwin exposes deeper crustal levels than surrounding areas, this study of its geologic structure and history adds significantly to our knowledge of the geotectonic setting and history of the Scotia Arc region as a whole. The Late Mesozoic tectonics exhibited in the southern Andes (analogous to present day Western Pacific tectonics) seem to be unique in the Andes except perhaps for the extreme north (GANSSE 1973). The mid-Cretaceous reactivation (penetrative deformation) of basement rocks that accompanied strong deformation and metamorphism of the cover rocks in the Cordillera Darwin has been as yet unrecognized elsewhere in the Andes. Although the presence of basement rocks and their possible reactivation has previously been suggested (KRANCK 1932; KATZ 1964), this is the first detailed study delimiting the extent of exposed basement and the degree of reactivation.

The identification of basement lithologies in this study places important constraints on paleogeographic reconstructions of the Pacific margin of Gondwanaland. Significant amounts of volcanic rocks in the basement complex, together with the presence of other basement lithologies that are similar to latest Paleozoic–Early Mesozoic fore-arc deposits west of the Patagonian Batholith (Fig. 1; see DALZIEL et al. 1975; FORSYTHE & MPODOZIS 1979), place the area of the Cordillera Darwin in a near-arc (probably fore-arc) tectonic setting prior to the widespread (?) subduction-related Late Jurassic volcanism. It is hoped that ongoing, more detailed study of the lithologic and stratigraphic relations in and around the Cordillera will thus



give a greater insight into the geological history of the southern Andes *prior* to the opening of the Early Cretaceous marginal basin.

Our observations on the deformation and metamorphism of the rock suites in the Cordillera Darwin have resulted in a fairly complete picture of events *subsequent* to formation of the marginal basin, during which the marginal basin was destroyed. The overall structural style (thick-skinned tectonics, polyphase ductile deformation, high-grade regional metamorphism, post-tectonic granite intrusion) is common to many other orogenic belts, particularly ones resulting from continent/continent collision. It is thus interesting to compare the Cordillera Darwin with one of the best known of these collision belts, the Central Alps (DIETRICH 1976; MILNES 1978). Indeed the scales and structures of the two chains are similar. From the point of view of structural style there seem to be two main differences between the two belts, but it is difficult to decide whether these merely reflect differences of degree (that is overall intensity of orogenic movement) or differences due to the fundamentally different geotectonic settings. Firstly, the remnants of ocean floor and thinned continental crust in the Central Alpine collision zone (the Pennine zone, see MILNES 1978) were completely shredded and dismembered, and interleaved with cover rocks, before, or at an early stage, in the main phase of penetrative/ductile deformation. Even in areas where the pre-Triassic basement must have had similar mechanical properties to the post-Triassic cover, thrust sheets developed which later suffered polyphase deformation. In contrast, the Cordillera Darwin seems to show no such mixing of basement and cover rocks prior to the main phases of ductile deformation  $D_1$ - $D_2$ . Basement and cover rocks were folded together, sometimes with the development of large recumbent folds and ductile thrust faults of Alpine character, but the surfaces affected were essentially stratigraphic, including the major pre-Late Jurassic unconformity. Secondly, the relation in space and time of the three early Andean fold systems leads to a tectonic synthesis (Fig. 8) which is remarkably un-Alpine. Particularly the conjugate zonal arrangement during  $D_2$  lacks even approximate Alpine equivalents. It may be, however, that this reflects an overall lower intensity of strain in comparison to the Alps, since a reversal of vergence similar to our  $D_1$ - $D_3$  relationship is now well documented (the late stage "back folding" of the Western Alps, see STECK et al. 1979, HOMEWOOD et al. 1980).

The southern Andean cordillera is not, however, a collision orogen between major continental plates. Rather it represents a magmatic arc-marginal basin-continental margin system whose tectonic elements have been heterogeneously deformed and uplifted. The Antler and Sonoma orogens of the western North American Cordillera are two deformed belts representing analogous magmatic arc-marginal basin (or ocean) systems which have been closed out against the western margin of the North American craton (BURCHFIEL & DAVIS 1972; SILBERLING 1973). However, the deformation associated with these orogenic events, although not well-known in detail, is quite different in style. In general these orogens represent deformed marginal basin or oceanic sequences juxtaposed against relatively undeformed continental shelf rocks. This juxtaposition occurred along narrow, low-angle thrust zones (Roberts Mountains thrust, Golconda thrust) and involved no known deformation of the underlying continental basement rocks (thin-skinned tectonics).

If a comparison is to be drawn with western North America it could be with what have now been termed the "metamorphic core complexes" (ARMSTRONG & HANSON 1966; CONEY 1979; DAVIS & CONEY 1979). These are localized regions in which cover and basement rocks have been involved in ductile deformation and regional type high grade metamorphism, as in the Cordillera Darwin, to a much greater extent than surrounding areas. The core complexes of North America are scattered over a distance of 2800 km (CONEY 1979, Fig. 1) along the Cordillera in various tectonic settings (including both arc and back-arc situations). It is a major point of debate, we believe, whether they form in a regional extensional tectonic environment (CONEY 1979; DAVIS & CONEY 1979) or in a compressional regime. The orogenic phase in Cordillera Darwin was certainly compressional but it took place at the end of a period of marked crustal extension (marginal basin formation). It seems, therefore, that the different metamorphic core complexes could have had different modes of origin and that the tendency to ascribe them all to the same causes should be avoided. Indeed, increasingly abundant evidence seems to indicate complex histories and variable modes of origin for different complexes of this type (SNOKE 1979; KIETH et al., in press).

In summary, the ductile deformation and associated medium to high grade metamorphism localized in the Cordillera Darwin occurred as a result of the closure of an arc-marginal basin-continental margin system. The thick-skinned style of ductile polyphase deformation involving both basement and cover, accompanied by high grade metamorphism is broadly similar to the Alpine continental collision zone, although significant differences exist. It is not, however, similar to the thin-skinned tectonics of the Sonoma and Antler orogens, which represent closure of analogous tectonic systems. The Cordillera Darwin is perhaps akin to metamorphic core complexes, whose origins are enigmatic at best.

### Acknowledgments

Our thanks are due to Captain P. Lenie and the entire crew of Research Vessel *Hero* and to the Chilean Empresa Nacional del Petroleo for the fine logistic support. The field work was assisted by D. Elthon, P. Nelson, R. Nelson, P. Uribe, I. Ridley and, for short periods, by numerous other Chilean and American geologists and students, too many to list separately. We appreciated helpful discussions with D. Elthon, R. Forsythe, F. Hervé, R. Schweickert, M. Suárez and M. Winslow. The manuscript was reviewed by R. Schweickert and W. Snyder. The financial support supplied by the Division of Polar Programs of the U.S. National Science Foundation under grants DPP-74-21415 and DPP-78-20629 and, for one of us (AGM), by the ETH Zürich is gratefully acknowledged.

### REFERENCES

- ARMSTRONG, R.L., & HANSEN, E.C. (1966): *Metamorphic infrastructure in the eastern Great Basin*. - Amer. J. Sci. 264, 112-127.
- BARKER, P.F., & GRIFFITHS, D.H. (1972): *The evolution of the Scotia Ridge and Scotia Sea*. - Phil. Trans. r. Soc. London 271, 151-183.
- BARKER, P.F., DALZIEL, I.W.D., et al. (1976): Init. Rep. Deep Sea Drill. Proj. 36, U.S. Government Printing Office, Washington.
- BRUHN, R.L. (1979): *Rock structures formed during back-arc basin deformation in the Andes of Tierra del Fuego*. - Bull. geol. Soc. Amer., Part I, 90, 998-1012.

- BRUHN, R. L., STERN, C. R., & DE WIT, M. J. (1978): *Field and geochemical data bearing on the development of a Mesozoic volcano-tectonic rift zone and back-arc basin in southern-most South America*. - Earth and planet. Sci. Lett. 41, 32-46.
- BURCHFIELD, B. C., & DAVIS, G. A. (1972): *Structural framework and evolution of the southern part of the Cordilleran orogen, western United States*. - Amer. J. Sci. 272, 97-119.
- CHAPPELL, B. W., & WHITE, A. J. R. (1974): *Two contrasting granite types*. - Pac. Geol. 8, 173-174.
- CONEY, P. J. (1979): *Tertiary evolution of cordilleran metamorphic core complexes*. In: ARMENTROUT, J. M., COLE, M. R., & TERBEST, H. (Ed.): *Cenozoic Paleogeography of the Western United States* (p. 14-28). - Pacific Sect., Soc. Econ. Paleont. Mineral.
- DALZIEL, I. W. D. (1970): *Structural studies in the Scotia arc: the Patagonian and Fuegian Andes*. - Antarctic J. U.S. 5, 99-100.
- (in press): *The pre-Jurassic history of the Scotia Arc: a review and progress report*. In: CRADDOCK, C. (Ed.): *Antarctic Geoscience*. - Univ. Wisconsin Press, Madison.
- DALZIEL, I. W. D., CAMINOS, R., PALMER, K. F., NULLO, F., & CASANOVA, R. (1974): *Southern extremity of Andes: geology of Isla de los Estados, Argentine Tierra del Fuego*. - Bull. amer. Assoc. Petroleum Geol. 58, 2502-2512.
- DALZIEL, I. W. D., & CORTÉS, R. (1972): *Tectonic style of the southernmost Andes and the Antarcandes*. - 24<sup>th</sup> Int. Geol. Congr., Montreal, Canada, sect. 3, 316-327.
- DALZIEL, I. W. D., DE WIT, M. J., & PALMER, K. F. (1974): *A fossil marginal basin in the southern Andes*. - Nature 250, 291-294.
- DALZIEL, I. W. D., DOTT, R. H., WINN, R. D., & BRUHN, R. L. (1975): *Tectonic relations of South Georgia Island to the southernmost Andes*. - Bull. geol. Soc. Amer. 86, 1034-1040.
- DALZIEL, I. W. D., & ELLIOT, D. H. (1971): *Evolution of the Scotia Arc*. - Nature 233, 246-252.
- (1973): *The Scotia Arc and Antarctic margin*. In: NAIRN, A. E. M., & STEHLI, F. G. (Ed.): *The Ocean Basin and Margins. I. The South Atlantic* (p. 171-245). - Plenum, New York, London.
- DALZIEL, I. W. D., & FORSYTHE, R. D. (1978): *Du Toit's "Samfrau Geosyncline" and plate tectonics*. - Abstr. geol. Soc. Amer. (with programs) 7, 385 (as per correction in 1979 Abstracts).
- DALZIEL, I. W. D., & PALMER, K. F. (1979): *Progressive deformation and orogenic uplift at the southern extremity of the Andes*. - Bull. geol. Soc. Amer. 90, 259-280.
- DALZIEL, I. W. D., PRICE, D. P., & STIREWALT, G. L. (1970): *Structural studies in the Scotia arc: Elephant Island, Gibbs Island, Hope Bay and Livingston Island*. - Antarctic J. U.S. 5, 100-101.
- DARWIN, C. (1890): *On the structure and distribution of coral reefs; geological observations on the volcanic islands and parts of South America visited during the voyage of H.M.S. Beagle*. - Ward, London.
- DAVIS, G. H., & CONEY, P. J. (1979): *Geologic development of the Cordilleran metamorphic core complexes*. - Geology 7, 120-124.
- DE WIT, M. J. (1977): *The evolution of the Scotia Arc as a key to the reconstruction of southwestern Gondwanaland*. - Tectonophysics 37, 53-81.
- DIETRICH, V. J. (1976): *Plattentektonik in den Ostalpen. Eine Arbeitshypothese*. - Geotekt. Forsch. 50, 1-84.
- DU TOIT, A. L. (1937): *Our Wandering Continents*. - Oliver & Boyd, Edinburgh.
- FERUGLIO, E. (1949): *Descripcion geologica de la Patagonia* (vol. 1-3). - Direccion Generale Yacimientos Petroliferas Fiscales, Buenos Aires.
- FORSYTH, D. W. (1975): *Fault plane solutions and tectonics of the south Atlantic and Scotia Sea*. - J. Geophys. Res. 88, 1429-1443.
- FORSYTHE, R. D. (1978): *Geologic reconnaissance of the pre-Jurassic basement, Patagonian Andes*. - Antarctic. J. U.S. 13, 10-12.
- FORSYTHE, R. D., & ALLEN, R. B. (in press): *The basement of Peninsula Staines, Region XII, Province of Ultima Esperanza, Chile*. - Rev. Geol. Chile.
- FORSYTHE, R. D., & MPODOZIS, A. C. (1979): *El Archipiélago Madre de Dios, Patagonia occidental, Magallanes: rasgos generales de la estratigrafía y estructura del "basamento" pre-Jurásico superior*. - Rev. Geol. Chile 7, 13-29.
- GANGULY, J. (1972): *Staurolite stability and related paragenesis: theory, experiments and applications*. - J. Petrol. 13, 335-365.
- GANSSER, A. (1973): *Facts and theories on the Andes*. - J. Geol. Soc. (London) 129, 93-131.
- GROEBER, P. (1952): *Mesozoico*. In: *Geografía de la Republica Argentina* (vol. 11). - Soc. argent. Estud. Geogr. Gaea., Buenos Aires.

- HALPERN, M. (1973): *Regional geochronology of Chile south of 50° latitude*. – Bull. geol. Soc. Amer. 84, 2407–2422.
- HERRON, E. M., BRUHN, R., WINSLOW, M., & CHUAQUI, L. (1977): *Post-Miocene tectonics of the margin of southern Chile*. In: TALWANI, M., & PITMAN, W. C. (Ed.): *Island Arcs, Deep Sea Trenches and Back-arc Basins* (p. 273–283). – Amer. Geophys. Union, Washington D.C.
- HERVÉ, F., NELSON, E., & SUÁREZ, M. (1979): *Edades radiométricas de granitoides y metamorfitas provenientes de Cordillera Darwin, Región XII, Chile*. – Rev. Geol. Chile 7, 31–40.
- HERVÉ, F., NELSON, E., KAWASHITA, K., & SUÁREZ, M. (in prep.): *New isotopic dates and their bearing on timing of events in the Cordillera Darwin, southernmost Chilean Andes*.
- HOMEWOOD, P., GOSSO, G., ESCHER, A., & MILNES, A. G. (1980): *Cretaceous and Tertiary evolution along the Besançon–Biella traverse (Western Alps)*. – Eclogae geol. Helv. 73/2, 635–649.
- KATZ, H. R. (1964): *Some new concepts on geosynclinal development and mountain building at the southern end of South America*. – Proc. 22<sup>nd</sup> Int. Geol. Congr., New Delhi 4, 241–255.
- (1973): *Contrasts in tectonic evolution of orogenic belts in the south-east Pacific*. – J. r. Soc. New Zealand 3, 333–362.
- KIETH, S. B., DAMON, P. E., REYNOLDS, S. J., SHAFIQUILLAH, M., LIVINGSTON, D. E., & PUSHKAR, P. D. (in press): *Evidence for multiple intrusion and deformation within the Santa Catalina–Rincon–Tortolita metamorphic core complex*. In: CRITTENDEN, M. D., CONEY, P. J., & DAVIES, G. H. (Ed.): *Tectonic Significance of Metamorphic Core Complexes of the North American Cordillera*. – Mem. geol. Soc. Amer. 153.
- KRANCK, E. H. (1932): *Geological investigations in the Cordillera of Tierra del Fuego*. – Acta geogr., Helsinki.
- MILNES, A. G. (1978): *Structural zones and continental collision, Central Alps*. – Tectonophysics 47, 369–392.
- NATLAND, M. L., GONZALES, P. E., CANON, A., & ERNST, M. (1974): *A system of stages for correlation of Magallanes basin sediments*. – Mem. geol. Soc. Amer. 139.
- NELSON, E., DALZIEL, I. W. D., & RIDLEY, I. (in press): *Geological studies in Cordillera Darwin, R/V HERO Cruises 77-4 and 78-2*. – Antarctic J. U.S.
- NELSON, E., FORSYTHE, R., HERVÉ, F., SUÁREZ, M., VALENZUELA, E., & WILSON, T. (1977): *Observaciones estructurales en la Cordillera Darwin, provincias Antártica y de Tierra del Fuego: Crucero 77-4 del R/V HERO*. – Notas cient. Univ. Chile, p. 32–35.
- PRICE, R. A., & GARDNER, D. A. C. (1979): *Porcupine Creek fan structure – tectonic significance of a reversal in regional structural vergence in the southern Canadian Rockies*. – Abstr. geol. Soc. Amer. 11, 499.
- RAYMOND, L. A. (1975): *Tectonite and mélangé – a distinction*. – Geology 3, 7–9.
- SCOTT, K. M. (1966): *Sedimentology and dispersal pattern of a Cretaceous flysch sequence, Patagonian Andes, southern Chile*. – Bull. amer. Assoc. Petroleum Geol. 50, 72–107.
- SILBERLING, N. J. (1973): *Geologic events during Permian–Triassic time along the Pacific margin of the United States*. In: LOGAN, A., & HILLS, L. V. (Ed.): *The Permian and Triassic Systems and their Mutual Boundary* (p. 345–362). – Mem. canad. Soc. Petroleum Geol. 2.
- SNOKE, A. W., MCKEE, E. H., & STERN, T. W. (1979): *Plutonic, metamorphic, and structural chronology in the northern Ruby Mountains, Nevada: a preliminary report*. – Abstr. geol. Soc. Amer. 11, 520–521.
- STECK, A., RAMSAY, J. G., MILNES, A. G., & BURRI, M. (1979): *Compte rendu de l'excursion de la SGS et la SSMP en Valais et en Italie nord du 2 au 5 octobre 1978*. – Eclogae geol. Helv. 72, 287–311.
- THOMAS, C. R. (1949): *Geology and petroleum exploration in Magallanes province, Chile*. – Bull. amer. Assoc. Petroleum Geol. 33, 1553–1568.
- URIEN, C. M., & ZAMBRANO, J. J. (1973): *The geology of the basins of the Argentine continental margin and Malvinas Plateau*. In: NAIRN, A. E. M., & STEHLI, F. G. (Ed.): *The Ocean Basins and Margins. I. The South Atlantic* (p. 135–170). – Plenum, New York, London.
- WINN, R. D. (1978): *Upper Mesozoic flysch of Tierra del Fuego and South Georgia Island: a sedimentological approach to lithosphere plate restoration*. – Bull. geol. Soc. Amer. 89, 533–547.
- WINSLOW, M. A. (1980): *Mesozoic and Cenozoic tectonics of the fold and thrust belt in southernmost South America and stratigraphic history of the cordilleran margin of the Magallanes basin*. – Ph.D. thesis, Columbia Univ.
- (in press): *Neotectonics and Cenozoic sedimentation in southernmost South America: Late Tertiary transcurrent faulting and the foreland fold and thrust belt of southern Chile*. In: CRADDOCK, C. (Ed.): *Antarctic Geoscience*. – Univ. Wisconsin, Madison.





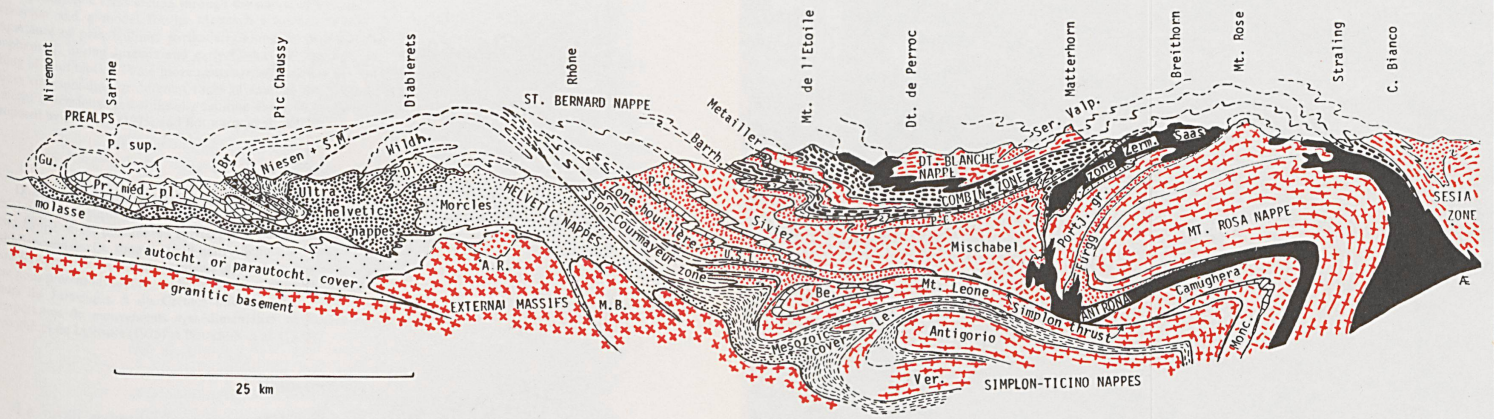

Diagrammatic cross section through the central part of the Western Alps

Compiled by A. Escher, A. Baud, M. Burri, C. Caron, G.V. Dal Piaz, G. Gosso, M. Grelller, P. Homewood, H. Masson, A.G. Milnes, R. Müller, R. Plancherel, B. Savary, J.P. Schaer, A. Steck, M. Weidmann.