

# Genetic-ecological investigations in "Biscutella levigata L." = Genetisch-ökologische Untersuchungen von "Biscutella levigata" L.

Autor(en): **Gasser, Max**

Objektyp: **Article**

Zeitschrift: **Veröffentlichungen des Geobotanischen Institutes der Eidg. Tech. Hochschule, Stiftung Rübél, in Zürich**

Band (Jahr): **86 (1986)**

PDF erstellt am: **23.07.2024**

Persistenter Link: <https://doi.org/10.5169/seals-308757>

## **Nutzungsbedingungen**

Die ETH-Bibliothek ist Anbieterin der digitalisierten Zeitschriften. Sie besitzt keine Urheberrechte an den Inhalten der Zeitschriften. Die Rechte liegen in der Regel bei den Herausgebern.

Die auf der Plattform e-periodica veröffentlichten Dokumente stehen für nicht-kommerzielle Zwecke in Lehre und Forschung sowie für die private Nutzung frei zur Verfügung. Einzelne Dateien oder Ausdrucke aus diesem Angebot können zusammen mit diesen Nutzungsbedingungen und den korrekten Herkunftsbezeichnungen weitergegeben werden.

Das Veröffentlichen von Bildern in Print- und Online-Publikationen ist nur mit vorheriger Genehmigung der Rechteinhaber erlaubt. Die systematische Speicherung von Teilen des elektronischen Angebots auf anderen Servern bedarf ebenfalls des schriftlichen Einverständnisses der Rechteinhaber.

## **Haftungsausschluss**

Alle Angaben erfolgen ohne Gewähr für Vollständigkeit oder Richtigkeit. Es wird keine Haftung übernommen für Schäden durch die Verwendung von Informationen aus diesem Online-Angebot oder durch das Fehlen von Informationen. Dies gilt auch für Inhalte Dritter, die über dieses Angebot zugänglich sind.

**Genetic-ecological investigations  
in *Biscutella levigata* L.**

Genetisch-ökologische Untersuchungen von *Biscutella levigata* L.

by

Max GASSER

1986



Nothing in biology makes sense  
except in the light of evolution.

TH. DOBZHANSKY

## CONTENTS

1. Introduction	7
2. The study area	12
2.1. General description	12
2.2. Characteristics of the local sectors studied	14
2.2.1. Dolomite	15
2.2.2. Serpentine	21
2.2.3. Acidic silicate	25
3. Studies on reproductive behaviour	26
3.1. Methods	26
3.1.1. Experimental pollinations	26
3.1.2. Germinating behaviour and early life phases	27
3.1.3. Transplantations in the field	30
3.2. Results	32
3.2.1. Experimental pollinations	32
3.2.2. Germinating behaviour and early life phases	33
3.2.3. Transplantations in the field	44
4. Demographic studies	47
4.1. Methods	47
4.1.1. Spatial distribution	49
4.1.2. Temporal distribution	50
4.2. Results	52
4.2.1. Spatial distribution	52
4.2.2. Temporal distribution	62
5. Discussion	75
Summary - Zusammenfassung	81
References	82



## 1. INTRODUCTION

Variation in plants is an expression of adaptation to particular environmental conditions. Differences in gene pool of the population, controlled not only by external but also by physiological isolation mechanisms (e.g. GRANT 1981, WHITE 1978), may represent various degrees of evolutionary divergence.

Speciation in plants is very complex and comprises numerous processes; its course may also vary from one group to another. VALENTINE (1962) distinguished principally between progressive and abrupt speciation; progressive or gradual speciation was defined as a differentiation process taking place by degrees, whereas abrupt speciation was characterised by a sudden change in number or structure of chromosomes. On the other hand, GRANT (1981) distinguished between primary speciation and hybrid speciation, emphasizing the degree of evolutionary divergence rather than the actual speed of evolution. The starting point of the primary speciation is a single genetically polymorphic population, whereas hybrid speciation is preceded by hybridization of two different taxa. Primary speciation is further subdivided into (i) geographical, (ii) quantum, and (iii) sympatric speciation.

The geographical speciation is the best known form of primary speciation. The first step in this process is the formation of local races. The increasing spatial isolation of populations may lead to the formation of geographical races. The beginning of reproductive isolation sets in at this stage. Reproductive isolation mechanisms which develop during the period of spatial isolation of two or more populations enable them to coexist without interbreeding even if they are brought together again. Formation of semi-species and species can be considered as an extension of these processes.

Quantum speciation leads from a local race to a new species, the intermediate stage being a small isolated or semi-isolated peripheral population. The variation-fixing forces in the process are selection and genetic drift, resulting in essential alternations of the genome. Quantum speciation is frequently accompanied by a drastic reduction in the size of the population.

Sympatric speciation so far remains a theoretical possibility (GRANT

1981). It postulates a short pathway from polymorphism to species within one single population by way of disruptive selection, no intermediate stage of racial differentiation being involved. In an ecologically very heterogeneous environment of high selective value, divergence to the species level might take place, especially if a small neighbourhood and/or partly asexual reproduction limit the gene-pool of a given sector of the population.

The genetical polymorphism in plant populations is influenced by various factors, reproductive behaviour and selection being of particular importance. Genetic variability is promoted by an open recombination system and reinforced by a wide dispersal of pollen and seed, but it decreases when selective pressures are strong. Pronounced differences in ecological conditions can lead to a strong differentiation even within a limited area (e.g. ANTONOVICS 1971) and races may be formed rapidly (e.g. WU and ANTONOVICS 1976).

Natural selection is a demographic process. Adaptation may thus be operationally definable in terms of mortality and fecundity, because particular individuals in a given population may show differences in survival and reproduction (ANTONOVICS 1976). Demographic parameters such as e.g. population size, density, and age structure seem to be useful in assessment of ecological and/or genetical differences between as well as within populations.

Plant demography is a rather young discipline issued from zoology; however, there are important differences in demographic behaviour between animals and plants. On account of their sedentary life, populations of plants may in some aspects be easier to study (HARPER 1977). On the other hand, plants may vary enormously in form and size. In plants with extensive clonal growth, identification of genotypes (genets) is sometimes virtually impossible because the clonal units (ramets) may be connected below ground. The seed dormancy may also make the demographic studies quite difficult. The specific aspects of plant life were taken into consideration in some concepts recently proposed in plant demography. For instance, HARPER and WHITE (1974) introduced the term of meta-population considered as a sum of modules viz. buds, shoots, or leaves; in our opinion, ramets could also be treated as modules.

A correct assessment of age is rather difficult in many plants, herbs being a particularly complex material. Precise life tables have been

established so far only for a few perennial herbs (KERSTER 1968, LEVIN 1973). To deal with these difficulties RABOTNOV (1978) proposed the term of "coenopopulation". RABOTNOV who developed the original idea of PETROVSKII (1961) determined coenopopulation as a sum of specimens representing various age groups per unit area, the buried seeds included.

The classification of RABOTNOV (1978) relates to age-state rather than to the actual chronological age; it is based on four main periods in the life of plants reproducing by seeds:

- 1) The period of primary dormancy when individuals exist as viable seeds under natural conditions.
- 2) The virginal period lasting from germination to flowering.
- 3) The generative period - reproduction by seeds.
- 4) The senile period.

Demographic investigations are usually carried out in permanent plots; however, the methods used are, for the time being, far from being coordinated. For instance, SARUKHAN and HARPER (1973) adapted a pantograph to produce plant distribution maps on the scale of 1:5. TAMM (e.g. 1948, 1972 a,b) used for the same purpose a wire screen of 50 cm by 50 cm. DICKENMANN (1982) located the place of each individual of two Ranunculus taxa in a coordinate grid system. URBANSKA and LANDOLT (1978) showed the distribution pattern of reproducing plants in Cardamine spp. in form of a simplified raster map. The fidelity of such investigations depends e.g. on the size of the fine wire squares or exactness of the pantograph. Frequent controls are necessary in order to recognize all the specimens in the plot studied.

The raw census data serve to calculate recruitment of new plants, deaths, survivorship curves, and depletion curves. Also half lives and mean life expectancy can be estimated (e.g. DEEVEY 1947, HARPER 1967, 1977, 1978). The fate of plants can be followed directly in long-term studies (e.g. TAMM 1948-1972).

Demographic studies in high-altitude ecosystems have not been carried out to date. On account of the extreme life conditions and strong selective pressures occurring in the alpine vegetation belt, an area above the timberline was chosen for the present study.

Development of alpine soils frequently being not much advanced, edaphic factors may promote formation of local races (see e.g. LANDOLT 1971,



URBANSKA and SCHWANK 1980, DICKENMANN 1982). Taxa occurring on various alpine substrata are thus particularly interesting for study of a possible racial differentiation. Biscutella levigata s.str. chosen for the present study, grows in the Swiss Alps on carbonate, serpentine, and sometimes also on acidic silicate. Another reason for choosing Biscutella levigata was its complex reproductive strategy. B. levigata reproduces sexually and also forms ramets from adventitious root buds; the specialized form of clonal growth has a potential for vegetative multiplication, clone fragmentation being enhanced by alpine soil movements.

The classical studies of MANTON (1934, 1937) revealed the existence of diploid, tetraploid, and hexaploid races. The hexaploid race is known from only one locality in Spain. The tetraploid B. levigata s. str. has a continuous distribution throughout the Alps. The diploids form a series of disjunct populations in the lowlands north, east, and south of the Alps and occur as well in the Bernese Oberland (HESS et al. 1977). The geographical and ecological distribution of the diploids and tetraploids, when compared to the geological past of the area, suggests that the lowland diploid populations are relicts of an interglacial flora. The alpine tetraploid B. levigata, on the other hand, occurs in an area that was covered by ice during the last glacial period, and therefore appears to be a post-glacial immigrant (MANTON 1934).

Our preliminary observations (GASSER 1981) revealed that the demographic behaviour of Biscutella levigata occurring in high altitude sites on dolomite and serpentine followed two different patterns. In dolomite grassland the taxon occurred in a low density; on the other hand, a relatively high density was observed on dolomite scree slopes and in open serpentine vegetation (GASSER 1983). Racial differentiation in B. levigata was reflected in the germinating behaviour and in the pattern of seedling establishment, although no differences were observed in the morphological or cytological characteristics (GASSER 1981). The present study deals with further aspects of microdifferentiation and demography in alpine populations on the two substrata.

#### **ACKNOWLEDGEMENTS**

The autor is indebted to Professor Dr K. Urbanska for her advice, encouragement, and criticism throughout the course of the investigations and the preparation of the manuscript. Thanks are due to Professor Dr E. Landolt who followed the study with constructive criticism.

I am grateful to HR. Binz and Dr O. Wildi who helped with mathematical analysis and computer programs and U. Glanzmann who typed the demographic data. R. Graf made copies of the photos, Mrs S. Türler made many suggestions on style and use of the English language, Mrs E. Wohlmann drew the figures, H.P. Ackermann and F. Müller cultivated the plants. My sincere thanks are addressed to these persons as well as to numerous colleagues from the Geobotanical Institute and the "Alpine Group" in Davos who occasionally helped throughout the course of the work.

The financial support of the Swiss National Science Foundation grant 3.094-0.81 is gratefully acknowledged.

## 2. THE STUDY AREA

### 2.1. GENERAL DESCRIPTION

The study area is located north of Davos in the Eastern Central Alps (Grisons, E Switzerland). The control plots are situated above the timberline, between 2200 m and 2600 m a.s.l. on slopes generally oriented to the south (Fig. 1, Table 1).

The climate in the study area is characterized by a precipitation of about 1100 mm/y. The mean temperature is about  $-1^{\circ}\text{C}$  and the mean duration of the snow cover is from October to June; snowfall and frost are possible during the whole year (Fig. 2).

The study area is geologically very heterogeneous (Fig. 1), three main substratum types viz. dolomite, serpentine, and acidic silicate being quite distinct. For further information about the geological structure and tectonic layers see the Geological Map of the Grisons, 1:25000, part B (CADISCH et al. 1929). More details concerning vegetation and soil properties on dolomite and acidic silicate in the research area are given by GIGON (1971), the corresponding data on serpentine by EGGER (in prep.).

The ecological conditions within the study area are very variable: dense grassland, open scree slopes, and intermediate niches alternate on slopes of varying gradient. The duration of snow cover also varies: in wind-exposed areas the snow is often blown away in winter, while in sheltered depressions the snow cover is deeper and melts more slowly in spring.

Grazing animals occur frequently in some parts of the study area. The dolomite grassland is usually grazed by sheep and seldom cattle, but wild animals (Capra ibex, Marmota marmota, Rupicapra rupicapra, Lagopus mutus) occur within the whole area.

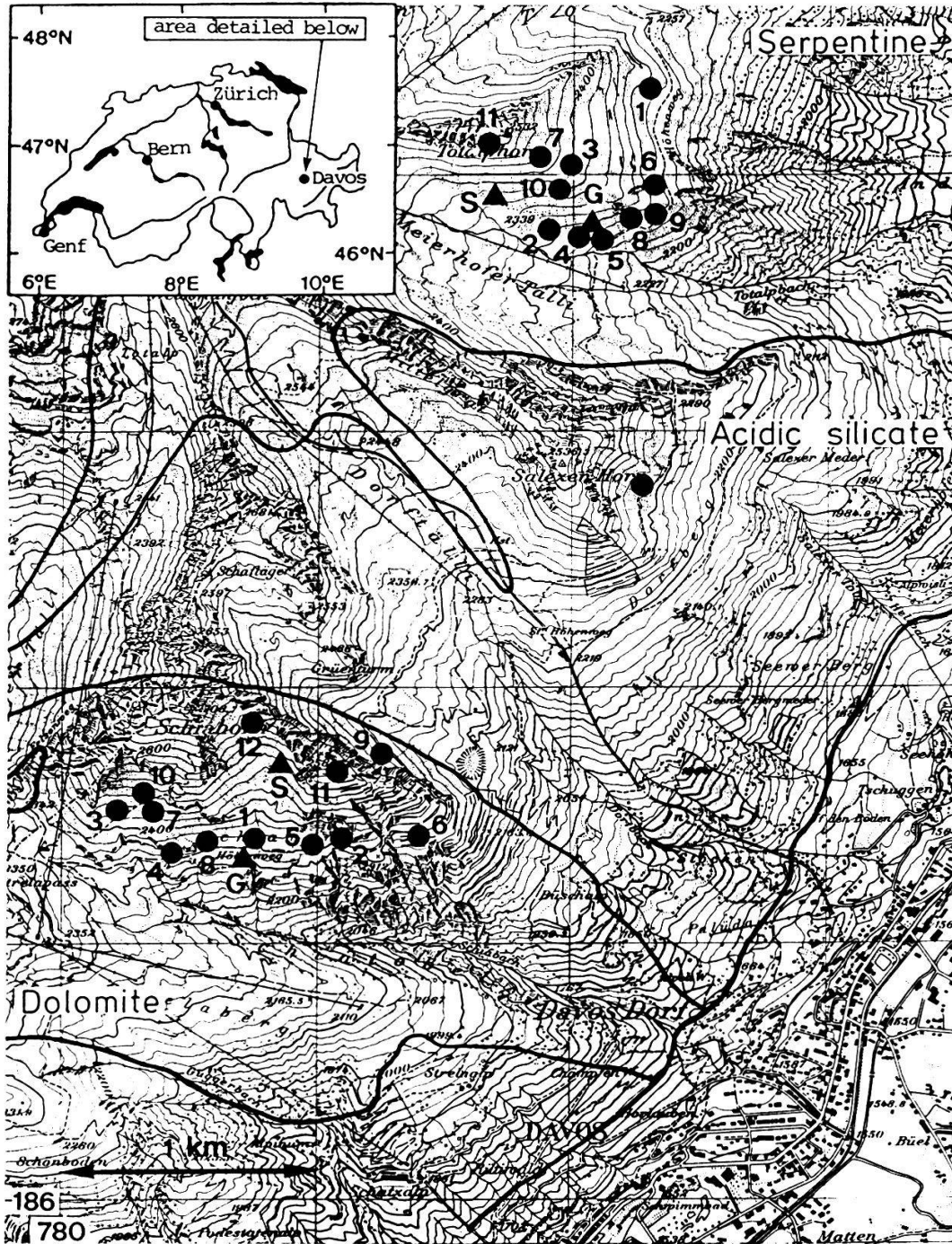

Fig. 1. Location of the study areas and the boundaries of the geological substrata; inset the relationship to other places in Switzerland. (Reproduced by permission of the Swiss Federal Office of Topography, 30 Oct. 1984).

Abb. 1. Lage des Untersuchungsgebietes und Grenzen des geologischen Substrates.

- ▲ = experimental plots G = on grassland, S = on scree.
- = natural subpopulations used in the demographic studies.

2.2. CHARACTERISTICS OF THE LOCAL SECTORS STUDIED

Biscutellia levigata occurs in various niches; the local sectors selected for the present study are accordingly situated upon various substrata and also support various types of vegetation (Table 2). The development

Table 1. Characteristics of the local sectors.

Tab. 1. Charakterisierung der Untersuchungsflächen.

- = not covered by stones, (+) = scarcely covered, + = moderately covered, ++ = scree slope

DOL = dolomite, SER = serpentine, SIL = acidic silicate

Plot code	Altitude a.s.l. (m)	Exposition	Slope %	Vegetation cover %	Surface rock cover	Remarks
DOL 1	2350	S	35	95	(+)	grassland
DOL 2	2340	S	75	70	(+)	grassland
DOL 3	2430	S	40	80	(+)	grassland
DOL 4	2330	S	35	70	+	intermediate
DOL 5	2340	S	50	60	+	intermediate
DOL 6	2300	S	50	50	(+)	intermediate
DOL 7	2440	S	50	60	+	intermediate
DOL 8	2360	S	60	40	++	scree slope
DOL 9	2320	E	60	30	++	scree slope
DOL 10	2460	S	50	20	++	scree slope
DOL 11	2560	S	55	20	+	highest site
DOL 12	2540	S	60	70	(+)	highest site
SER 1	2290	S	30	60	-	dense vegetation
SER 2	2300	S	35	60	(+)	dense vegetation
SER 3	2400	ESF	25	70	-	dense vegetation
SER 4	2280	S	45	25	(+)	intermediate
SER 5	2270	S	50	35	(+)	intermediate
SER 6	2280	E	30	20	(+)	intermediate
SER 7	2430	SSE	30	30	+	intermediate
SER 8	2280	SW	50	20	++	sparse veg.
SER 9	2280	SE	40	15	(+)	sparse veg.
SER 10	2380	S	50	10	+	sparse veg.
SER 11	2510	S	70	5	++	highest site
SIL	2320	E-S	30-60	70	-	grassland

of grazing. It should be noted that even the limited surfaces are frequently heterogeneous and comprise numerous microniches.

### 2.2.1. Dolomite

#### Grassland (DOL 1, DOL 2, DOL 3, Figs 3,4)

The sectors studied represented rather dense alpine meadow grassland with a plant height of 15-30 cm; the vegetation corresponded to the Seslerio - Caricetum sempervirentis association or to transitions between Seslerio - Caricetum and Caricetum firmae (Table 2). The sector DOL 2 was a well-developed terraced grassland ("Treppenrasen", Fig. 4). The soils were rendzinas with a varying amount of organic matter. The sectors DOL 1 and DOL 3 were frequently grazed by cattle, sheep, and wild animals.

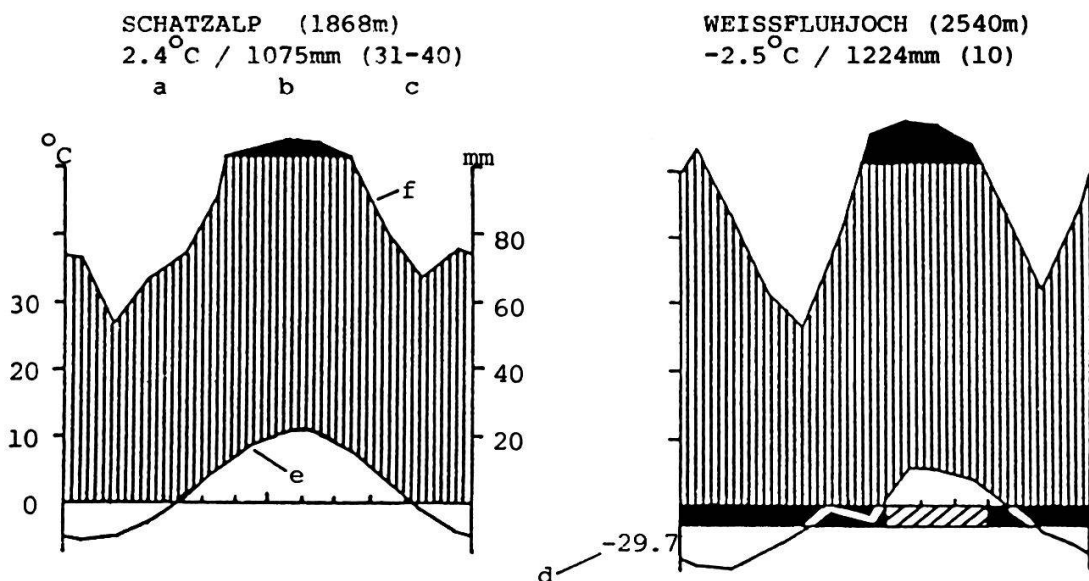

Fig. 2. Climatic diagram of Schatzalp (from WALTER and LIETH 1960-1967) and of Weissfluhjoch (from GIGON 1971).

Abb. 2. Klimadiagramm der Schatzalp und des Weissfluhjochs.

- |                              |                                |
|------------------------------|--------------------------------|
| a: mean annual temperature   | d: lowest temperature recorded |
| b: mean annual precipitation | e: curve of mean monthly temp. |
| c: duration of observations  | f: curve of mean monthly prec. |
| (left temp., right prec.)    |                                |

Ordinate: one division = 10°C or 20 mm rain, black 200 mm rain

Abscissa: months (January - December)

Table 2. Phytosociological relevés taken in the local sectors studied. Frequency according to BRAUN-BLANQUET (1964).  
Tab. 2. Vegetationstabelle der Untersuchungsflächen.

Taxon	DOL	SER	SIL
	111 123456789012	11 12345678901	
<i>Biscutella levigata</i>	++1+++1+211+	+11+1+1++++	+
<i>Campanula scheuchzeri</i>	+++++++ ++	+++++++ ++	+
<i>Minuartia verna</i>	+1+++ + 11+	+ +++ +++++	
<i>Silene willdenowii</i>	+ ++1++11	+ +1++++1+	
<i>Thymus polytrichus</i>	+++++ + +	++ ++++++	
<i>Festuca pumila</i>	1111 +1+ 11	11 11+++	
<i>Viola calcarata</i>	+ +++++ 11 +	++ +++++ ++	
<i>Anthyllis alpestris</i>	+1111 1+ 11	11 1 + +	
<i>Carex sempervirens</i>	3231212	112 1 +	1
<i>Gentiana campestris</i>	+++++ ++	+ + ++	
<i>Dryas octopetala</i>	++12 +31 1	+2 +	
<i>Carduus defloratus</i>	++ +11	+ + ++1+	
<i>Daphne striata</i>	++ ++ +	++ +	
<i>Euphrasia minima</i>	+1 ++	++ +	1
<i>Homogyne alpina</i>	+ 1 ++	+ ++	+
<i>Erica carnea</i>	1 ++	++ +1 +	
<i>Polygala chamaebuxus</i>	++ +	+ 1 + ++	
<i>Selaginella selaginoides</i>	++ +	+++ ++	
<i>Silene acaulis</i>	+ 1	++ ++ +	
<i>Bellidiastrum michelii</i>	+ + +	+ ++	
<i>Thesium alpinum</i>	+ +++	+ +	
<i>Leontodon hyoseroides</i>	+ 1 +	+++ +	
<i>Ligusticum mutellinoides</i>	+ 1	1 1	+
<i>Campanula cochleariifolia</i>	+ ++	+ ++	
<i>Carex ornithopoda</i>	+ +	1 1	
<i>Antennaria dioeca</i>	+ +	+ +	
<i>Gentiana nivalis</i>	+ +	+ +	
<i>Sesleria coerulea</i>	213+1+2++11+		
<i>Galium anisophyllum</i>	++++++1+ +1		
<i>Helianthemum alpestre</i>	112++ 1+ 2		
<i>Carex firma</i>	+1222 + + 2		
<i>Androsace chamaejasme</i>	++1++ 1+ 1		
<i>Scabiosa lucida</i>	+11++11+		
<i>Draba aizoides</i>	+1 ++ + 1+		
<i>Hieracium villosum</i>	+ ++1 + +		
<i>Myosotis alpestris</i>	+ + ++ +1		
<i>Ranunculus montanus</i>	+ + + ++ +		
<i>Polygonum viviparum</i>	+++ ++ +		
<i>Salix serpyllifolia</i>	+ 22 +11		
<i>Leontodon hispidus</i>	+ +++ +		
<i>Chrysanthemum adustum</i>	+ ++1		
<i>Poa alpina</i>	+ 111+		
<i>Hutchinsia alpina</i>	+ 11++		
<i>Gentiana clusii</i>	+++		





Table 2. (continued)

Species found only in one relevée (except for acidic silicate):

DOL 1:	<i>Ligusticum mutellina</i> (+)
DOL 2:	<i>Arctostaphylos uva-ursi</i> (+), <i>Globularia cordifolia</i> (1), <i>G. nudicaulis</i> (+), <i>Leontopodium alpinum</i> (+), <i>Nigritella nigra</i> (+), <i>Primula auricula</i> (+)
DOL 4:	<i>Carlina simplex</i> (+)
DOL 6:	<i>Botrychium lunaria</i> (+), <i>Helianthemum grandiflorum</i> (+)
DOL 7:	<i>Salix reticulata</i> (+), <i>Veronica aphylla</i> (+), <i>V. fruticans</i> (+)
DOL 9:	<i>Doronicum grandiflorum</i> (+), <i>Draba tomentosa</i> (+), <i>Hieracium bifidum</i> (+)
DOL 11:	<i>Elyna myosuroides</i> (2)
DOL 12:	<i>Draba carinthiaca</i> (+), <i>Gentiana verna</i> (+), <i>Saxifraga oppositifolia</i> (+), <i>Sedum alpestre</i> (+)
SER 2:	<i>Campanula barbata</i> (+), <i>Cardamine resedifolia</i> (+)
SER 3:	<i>Geum montanum</i> (1), <i>Potentilla aurea</i> (+)
SER 5:	<i>Calamagrostis villosa</i> (1), <i>Carex ericetorum</i> (+)
SER 7:	<i>Minuartia sedoides</i> (+)
SER 8:	<i>Lycopodium selago</i> (+)
SER 9:	<i>Larix decidua</i> (+)

DOL = dolomite, SER = serpentine, SIL = acidic silicate



Fig. 3. The local sector DOL 1, dolomite grassland.  
Abb. 3. Die Fläche DOL 1, Dolomitrasen.



Fig. 4. The local sector DOL 2, well-developed terraced grassland "Treppenrasen" on dolomite.  
Abb. 4. Die Fläche DOL 2, gut entwickelter Treppenrasen auf Dolomit.



Fig. 5. The local sector DOL 4, intermediate sector on dolomite.  
Abb. 5. Die Fläche DOL 4, intermediäre Fläche auf Dolomit.



Fig. 6. The local sector DOL 6, intermediate sector on dolomite; anti avalanche defense works.

Abb. 6. Die Fläche DOL 6, intermediäre Fläche auf Dolomit mit Lawinerverbauungen.



Fig. 7. The local sector DOL 8, dolomite scree slope.

Abb. 7. Die Fläche DOL 8, Dolomitschutthalde.

**Intermediate sectors** (DOL 4, DOL 5, DOL 6, DOL 7, Figs 5,6)

The open vegetation of the sectors corresponded rather to the same association as the grassland sectors (Table 2). Rock debris and fine earth material, brought down the slope by rockfall and snowmelt-runoff, occasionally covered the vegetation in all sectors. The soil was a slightly developed rendzina with only a small amount of fine soil. All sectors were grazed by wild animals, sectors DOL 4 and DOL 7 also by cattle.

**Scree slopes** (DOL 8, DOL 9, DOL 10, Fig. 7)

The open vegetation corresponded to transitions between Seslerion coeruleae and Thlaspietum rotundifolii (Table 2). The sectors were influenced by strong rockfall; with a possible damage to roots and stems of plants by the resulting debris. The undeveloped soil was liable to summer and autumn droughts. The sectors were seldom grazed.

**Highest sectors** (DOL 11, DOL 12, Fig. 8)

The vegetation of these two sectors corresponded to the same association as the scree slopes (Table 2). On account of the high altitude, the climatic conditions here were more extreme. The soil was a slightly developed rendzina; both sectors were very strongly grazed by ibex.

Most of the sectors described above were not directly influenced by man. The two sectors DOL 6 and DOL 11 are situated within barriers built to prevent avalanches and some mechanical damage of the turf could be observed.

2.2.2. Serpentine

**Sectors with dense vegetation** (SER 1, SER 2, SER 3, Fig. 9)

The vegetation of these sectors corresponded to the alliance Galio anisophyllo - Minuartion vernaе, but could not be assigned to any known association (Table 2). The soil was an alpine brown earth, and the sectors were occasionally grazed by cattle.

**Intermediate sectors** (SER 4, SER 5, SER 6, SER 7, Fig. 10)

The vegetation belonged more or less to the same alliance as in the sectors previously described (Table 2), but the soil was less developed and



Fig. 8. The local sector DOL 12, highest sector on dolomite.  
Abb. 8. Die Fläche DOL 12, höchste Fläche auf Dolomit.



Fig. 9. The local sector SER 1, dense vegetation on serpentine.  
Abb. 9. Die Fläche SER 1, hohe Vegetationsbedeckung auf Serpentin.



Fig. 10. The local sector SER 5, intermediate sector on serpentine.  
Abb. 10. Die Fläche SER 5, intermediäre Fläche auf Serpentin.



Fig. 11. The local sector SER 9, sparse vegetation on serpentine.  
Abb. 11. Die Fläche SER 9, niedrige Vegetationsbedeckung auf Serpentin.



Fig. 12. The local sector SER 11, highest sector on serpentine; the metallic frame used for demographic census is seen.

Abb. 12. Die Fläche SER 11, höchste Fläche auf Serpentin, der Metallrahmen für die demographischen Untersuchungen ist zu sehen.



Fig. 13. The local sector SIL, grassland on acidic silicate.

Abb. 13. Die Fläche SIL, Silikatrasen.

covered by more rock debris. Grazing was seldom observed and only wild animals viz. Rupicapra rupicapra and Lagopus mutus, were seen.

**Sectors with sparse vegetation** (SER 8, SER 9, SER 10, Fig. 11)

The vegetation of these sectors represented a pioneer stage on a virgin soil (Table 2). It did not correspond to any known association.

**Highest sector** (SER 11, Fig. 12)

The vegetation here was very scarce; only four species, viz. Biscutella levigata, Cerastium latifolium, Minuartia verna, and Silene willdenowii, occurred in the conditions of scree slopes and crevices.

**2.2.3. Acidic silicate** (SIL, Fig. 13)

The relatively low growing vegetation of the only sector studied on this substratum did not correspond to any described association (Table 2). The soil was an alpine brown earth. The sector was grazed by cattle and/or sheep.



### 3. STUDIES ON REPRODUCTIVE BEHAVIOUR

#### 3.1. METHODS

##### 3.1.1. Experimental pollinations

Material used in breeding experiments was sampled in 1978 (seeds only), 1980 and 1982 (rosettes). The samples originated from various local sectors within the research area (Table 3). The rosettes were chosen at random within their subpopulations and transferred to Zürich, where they were individually potted in garden soil and kept in the greenhouse of the Geobotanical Institute. Of about 60 specimens only 13 were flowering in spring 1983 and could be used for the experiments. Plants used in breeding experiments were tested for their polyploidy level. For this purpose, very young leaves were fixed for at least 24 hrs in a mixture of ethanol and acetic acid (3:1). The squashes were stained with lacto-propionic orcein according to DYER (1963); the same method was used in the previous cytological studies of the present author (GASSER 1981). All specimens studied proved to be tetraploid ( $2n=4x=36$ ). The results confirm the previous results of the author (GASSER 1981), obtained with the material from the same study area (Fig. 14).



Fig. 14. Metaphase of Biscutella levigata from serpentine (sector SER4), tetraploid level with  $2n=4x=36$  chromosomes, 1500x, (from GASSER 1981).

Abb. 14. Metaphase von B. levigata von Serpentin (SER 4). Tetraploide Stufe mit  $2n=4x=36$  Chromosomen.

Observations on breeding behaviour were carried out under the greenhouse conditions. Some plants were left for possible open pollinations, only a few individuals being isolated (control). Forced pollinations were carried out in three series:

- a) pollinations with the pollen of the same individual;
- b) pollinations with pollen from plants growing on the same substratum within the same and/or other subpopulations;
- c) pollinations with pollen from plants originating from other substrata.

The pollinations were made with a small brush, pollen from several flowers of the same plant being taken. In each series five flowers were pollinated and subsequently isolated with gauze. After 1 1/2 months the seeds were harvested and studied further in laboratory and greenhouse.

### 3.1.2. Germinating behaviour and early life phases

Three aspects were studied:

- a) Germinating behaviour under controlled laboratory conditions (Table 3).
- b) Germinating behaviour and development of young plants on alpine and garden soil in the greenhouse (Table 4).
- c) Germinating behaviour and development of young plants in the field (Table 5).

In the field, fruits were harvested in September 1980 (sectors DOL 6, SER 4, 5) and in September 1981 (sectors DOL 6, DOL 3, 7, 10, DOL 5, 8, SER 1, SER 4, 5, SER 3, 7, 10). Each sample consisted of fruits from several flowering shoots chosen at random.

Fruits, collected directly from plants, were dried at room temperature for several days and stored in paper bags also at room temperature, or in the refrigerator at 4°C. Prior to sowing, the pericarp was removed and well developed seeds were selected.

**Laboratory experiments** (Table 3). Seeds chosen at random were sown onto wet blotting paper in Petri dishes and incubated in a climatic chamber at a temperature regime of 20°C (Day, 13 hrs) and 10°C (Night, 11 hrs.). The relative air humidity was 80%. The samples were scored for germina-

tion in the light and in the dark, germination being defined as the stage where the radicle had penetrated the pericarp.

Table 3. Laboratory experiments; seeds sown on blotting paper.

Tab. 3. Klimakammerversuche; Samen ausgesät auf Fliesspapier.

DOL = dolomite, SER = serpentine.

Origin of seeds	N of seeds	Beginning of trial	Duration of trial	Aspect studied
DOL 6	100	10 Oct 80	45 days	germination in the light
SER 4,5	100			
DOL 3,7,10	50	6 Jan 83	67 days	germinating behaviour in the light
DOL 5,8	50			
DOL 6	50			
SER 1	50			
SER 3,7,10	50			
SER 4,5	50			
SIL	25			
DOL 6	10			
SER 1	10			

Table 4. Greenhouse studies.

Tab. 4. Gewächshausversuche.

DOL = dolomite, SER = serpentine, SIL = acidic silicate.

\* Seeds in these series were sown on blotting paper in the climatic chamber; young plants were subsequently potted into garden soil and transferred to the greenhouse.

\*\* Number of leaves was counted in 20 plants chosen at random.

\*\*\* Individual development was observed in all young plants developed.

Origin of seeds	N of seeds or plants	Beginning of trial	Duration of trial	Substratum	Aspect studied
DOL 6	100	18 Mar 81	177 days	dolomite soil	germinating behaviour
SER 4,5	100				
DOL 6	100	24 Mar 81	171 days	serpentine soil	N of leaves**
SER 4,5	100				
DOL 3,5,6,7,8,10	10	7 May 83	13 weeks	garden soil	leaf area
SER 1,3,4,5,7,10	10				
SIL	2				
DOL 6	8	3 Feb 81	22 months	garden soil*	weight of plant
SER 4,5	8				N of rosettes
experiment. pollination	159	18 Oct 83	9 months	garden soil*	germination individual*** development

Table 5. Field observations.

Tab. 5. Feldversuche.

DOL = dolomite, SER = serpentine.

\* number (N) of leaves, height, and diameter of rosettes were investigated in the best developed plants.

Origin of seeds	N of seeds	Beginning of trial	Duration of trial	Substratum	Aspect studied
DOL 6	100	7 Oct 80	4 years	DOL developed soil SER developed soil	N of plants N of leaves* height and diameter of rosettes*
SER 4,5	100				
DOL 6	100				
SER 4,5	100				
DOL 3,7,10	50	30 Sep 82	2 years	DOL scree	N of plants N of leaves* height and diameter of rosettes*
DOL 4,5	50				
DOL 6	50				
SER 1	50				
SER 3,7,10	50				
SER 4,5	50				
DOL 3,7,10	50				
DOL 4,5	50			SER scree	
DOL 6	50				
SER 1	50				
SER 3,7,10	50				
SER 4,5	50				

Observations on germinating behaviour of seeds developed after experimental pollinations were carried out under the same conditions. All seeds obtained were used.

**Greenhouse studies** (Table 4). Greenhouse trials were carried out in four series:

1) Seeds were sown in two trays (50 cm x 35 cm x 6 cm), one filled with dolomite soil and the other with serpentine soil brought from the study area. 100 seeds from dolomite and 100 seeds from serpentine in four rows per tray were sown in either tray. Seedlings and young plants were counted once a week; the number of leaves was counted once a week in twenty plants chosen at random.

2) In the second series flower pots (diameter 9 cm, height 9 cm) filled with garden soil were used. Two seeds each originating from dolomite, serpentine or acidic silicate were put into each pot. After germination, only one plant per pot was left for study of leaf area under competition-free conditions.

3) In the third series, 16 young plants obtained from seeds that origin-

ated from dolomite or serpentine were individually potted into garden soil. After 22 months they were taken out and washed; the number of rosettes per plant and the fresh weight of the whole plant were determined.

4) Young plants obtained from experimental pollinations were individually potted into garden soil and further development was studied.

**Field observations** (Table 5). In 1980, two experimental plots were established one on dolomite near the sector DOL 1 and one on serpentine within the sector SER 4 (Fig. 1). Prior to sowing, the existing vegetation was removed. In the serpentine plot, the soil was stabilised by burying wire netting perpendicular to the slope to a depth of 20 cm. A 1 m high wire fence was built to protect the trial surfaces from grazing animals. The experimental plot on dolomite was only marked with plugs and the seedlings were protected against grazing by wires laid loosely on the soil.

In 1982, two additional experimental plots were established on dolomite and on serpentine scree (Fig. 1). These trial surfaces were protected from rockfall and erosion by a light metal frame covered with wire netting.

The number of seedlings and young plants, the number of leaves, and the height and diameter of the rosettes in the field experiments were determined roughly once a month throughout a given vegetation period.

### 3.1.3. Transplantations in the field

At the beginning of September 1982, two additional experimental plots were set up near those established in 1980 (Fig. 1). They were protected from grazing animals by a wire fence. Material used in transplantations consisted of both reproducing and non-reproducing rosettes, but the inflorescences of reproducing rosettes were removed. In all, 200 specimens from the four local sectors DOL 7, DOL 8, SER 3, and SER 4 were planted in the two plots in block design (Fig. 15). Twice 50 rosettes originated from foreign substratum whereas 2 x 50 rosettes from the same substratum represented the control.

The transplantation plots were watered twice in September 1982. During 1983 and 1984 the reproducing and non-reproducing rosettes were scored once a month.

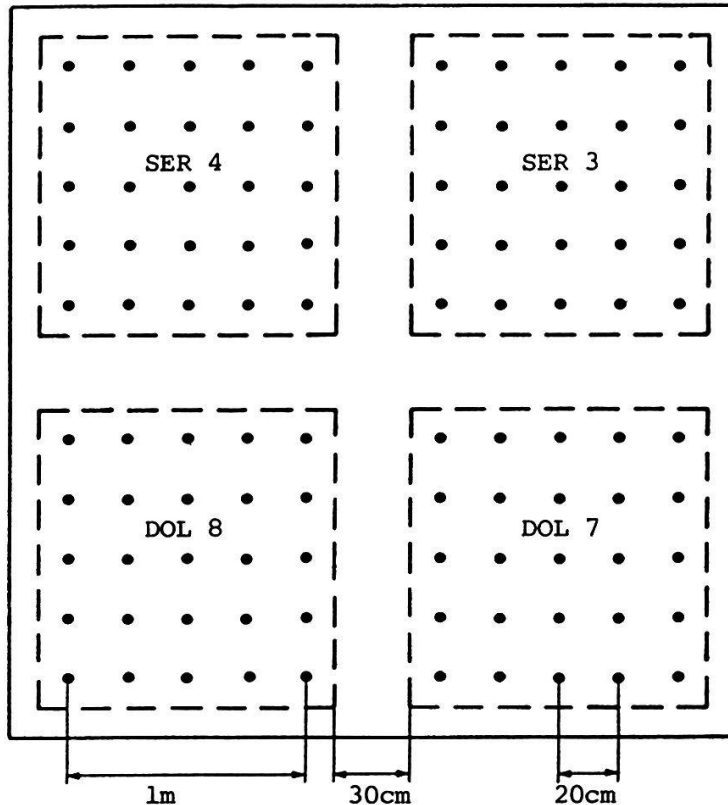

Fig. 15. Design of the transplantation experiments, marked with G in Fig. 1.

Codes (SER 4, SER 3, DOL 8, DOL 7) refer to the origin of the material used.

Abb. 15. Anordnung des Verpflanzungsexperiments, in Abb. 1 mit G markiert.

Abkürzungen beziehen sich auf die Herkunft des Materials.

Exemplified by the plot on serpentine:

upper squares = plants from the same substratum (control)

lower squares = plants from foreign substratum

obere Quadrate = Pflanzen vom gleichen Substrat

untere Quadrate = Pflanzen vom fremdem Substrat

### 3.2. RESULTS

#### 3.2.1. Experimental pollinations

**Selfings.** In open pollinations (control series), fruit and seed development was very seldom observed.

In forced selfings (Table 6), only two plants from dolomite, and a single one from serpentine developed fruit. The seeds obtained from

dolomite plants had a relatively low germination capacity whereas the only seed developed by the plant from serpentine did not germinate.

**Cross-pollinations.** All pollinated plants developed fruit and seeds; fruit and seed production was usually good (Table 7).

Crosses between plants originating from the same substratum resulted in a high fruit and seed output; the seeds germinated well. More complex results were obtained in crosses between plants from various substrata. When plants from dolomite were female parents and the pollen donors originated from serpentine, the crosses were very successful. In the reciprocal cross combination, however, both the fruit and seed output as well as the germination capacity of seeds were reduced (Table 7).

Table 6. Fruit and seed output in forced selfings.

Tab. 6. Früchte- und Samenproduktion bei den forcierten Selbstungen.

DOL = dolomite, SER = serpentine

Origin	N of pollinated plants	N of pollinated flowers	N of plants producing fruit	N of fruits	N of seeds	Germination
DOL	5	25	2	8 32%	7 14%	4 57%
SER	5	25	1	1 4%	1 2%	0 0%

Table 7. Fruit and seed output in cross pollinations.

(Female parent listed first).

Tab. 7. Früchte- und Samenproduktion bei den Kreuzbestäubungen.

(Weiblicher Elternteil zuerst aufgeführt).

DOL = dolomite, SER = serpentine

Cross combination	N of poll. shoots	N of poll. flowers	N of shoots producing fruit	N of fruits	N of seeds	Germination
DOL x DOL	4	20	4	17 85%	28 70%	28 100%
SER x SER	6	30	6	24 80%	43 72%	32 78%
DOL x SER	5	25	5	20 80%	35 70%	28 80%
SER x DOL	5	25	5	14 56%	23 46%	11 48%





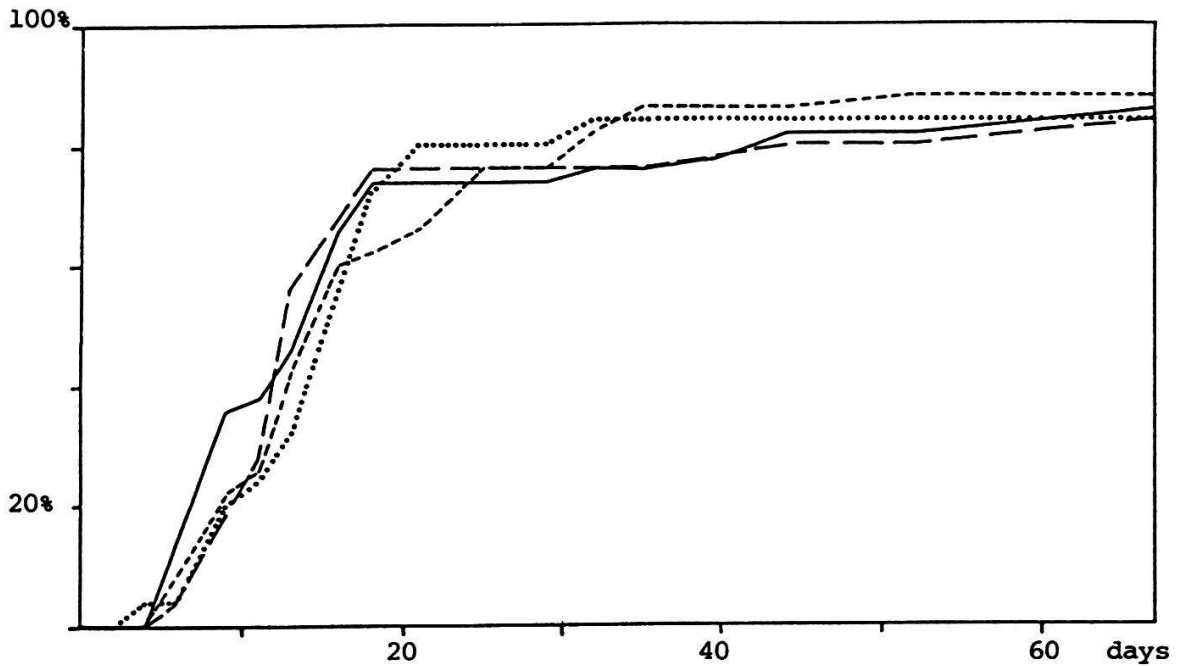

Fig. 17. Laboratory experiments: Germinating behaviour of Biscutella levigata from different local sectors on serpentine (50 seeds per series) and from acidic silicate (25 seeds per series).

Abb. 17. Klimakammerversuche: Keimungsverhalten von B. levigata aus verschiedenen Serpentinflächen und aus saurem Silikat.

SER 1: ——— SER 3, 7, 10: - - - SER 4, 5: - - - - SIL: .....

Table 8. Laboratory experiments: Seed germination.

Tab. 8. Klimakammerversuche: Samenkeimung.

DOL = dolomite, SER = serpentine, SIL = acidic silicate

\* Germination in the dark

Origin of seeds	N of seeds	Germination %
DOL 6	100	91
DOL 3,7,10	50	88
DOL 5,8	50	86
DOL 6	50	86
DOL 6	10	40*
SER 4,5	100	92
SER 1	50	86
SER 3,7,10	50	84
SER 4,5	50	88
SER 1	10	50*
SIL	25	84
Total:		
DOL	260	86.5
SER	260	86.9

**Greenhouse studies.** Seeds from dolomite and serpentine sown on dolomite and serpentine alpine soils began to germinate about one week after sowing. Germination percentages were lower than those obtained under laboratory conditions (Figs 18, 19, Table 9). The best germination (52%) was noted in seeds from dolomite sown on dolomite soil. On the other hand, seeds from serpentine sown on serpentine soil germinated only to 38%. Seeds from dolomite sown on serpentine soil and those from serpentine sown on dolomite soil had a germination rate of 36-38%.

The mortality rate of seedlings and very young plants studied in the same trial was mostly between 21% and 26%; only the plants from dolomite grown on serpentine soil showed a higher mortality viz. 40% (Table 9). Usually the plants died before reaching the age of 40 days (Fig. 18), but mortality of specific ages was not studied in detail.

The biomass accumulation at early life phases was assessed by the following parameters: number of leaves, area of leaf, fresh weight of plant, and number of rosettes.

The number of leaves was counted in twenty young plants chosen at random. The plants grown on dolomite soil showed good development regardless of the origin of seeds. The number of leaves increased continuously, the standard deviation being very high at an age of more than 100 to 120 days. On the other hand, the development of plants grown on serpentine soil was significantly slower and almost stopped at an age of more than 100 days (Figs 20, 21, Table 10). Also in this series, the actual origin of seeds had no significant effect on the behaviour of young plants.

Table 9. Greenhouse studies: Seed germination and mortality at early life phases (100 seeds per series).

Tab. 9. Gewächshausversuche: Samenkeimung und Sterblichkeit junger Lebensphasen.

Substrata	Dolomite		Serpentine	
	DOL	SER	DOL	SER
Seed origin				
Germination	52%	36%	38%	38%
Mortality	21%	22%	40%	26%

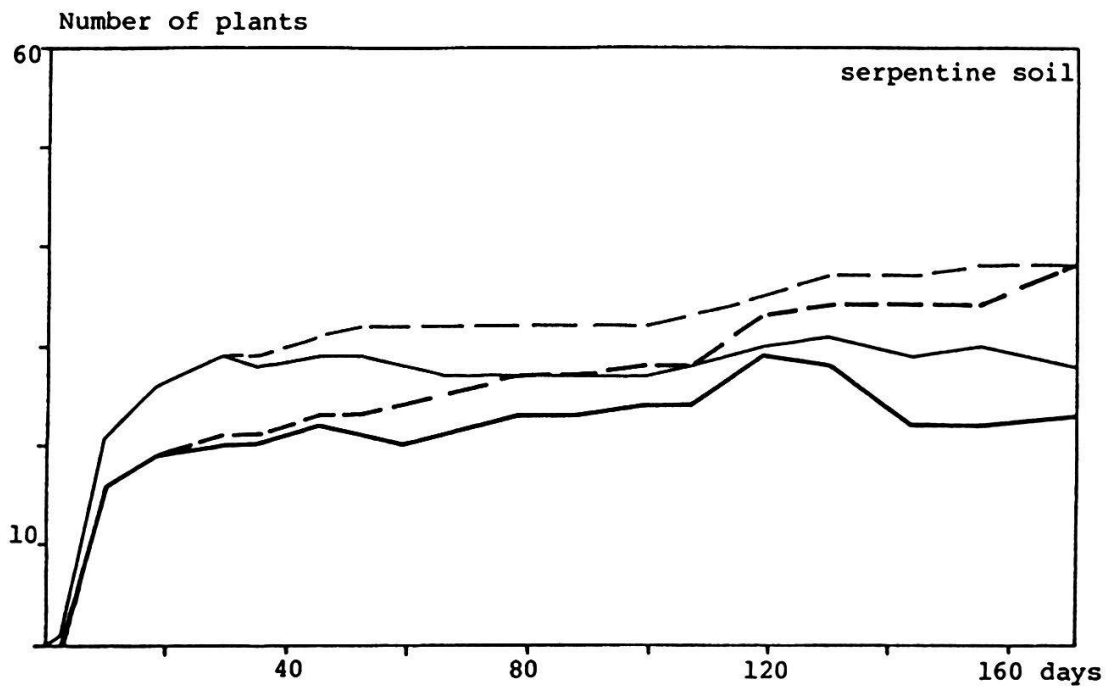
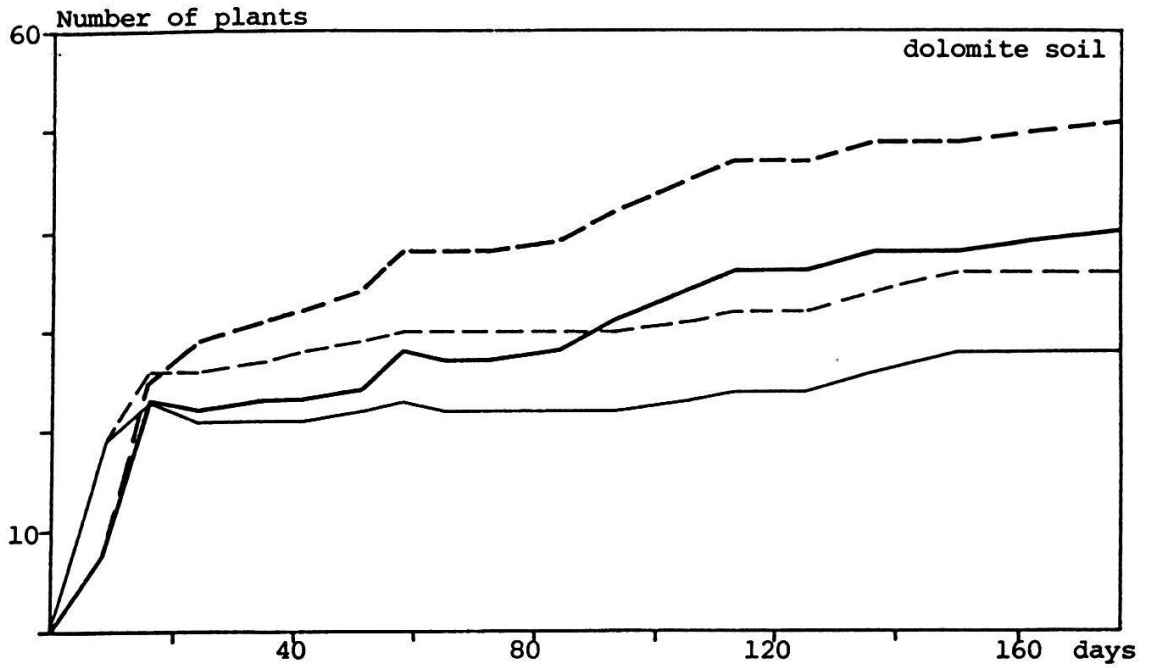

Figs 18,19. Greenhouse studies: Net number (solid line) and cumulative gains (dashed line) of seedlings / young plants on dolomite and serpentine soil (100 seeds per series).

Abb. 18,19. Gewächshausversuche: Nettoanzahl (ausgezogene Linie) und kumulativer Zuwachs (gestrichelte Linie) von Keimlingen / Jungpflanzen auf Dolomit- und Serpeninerde.

Plants from dolomite: ———— , ————  
Plants from serpentine: ———— , ————

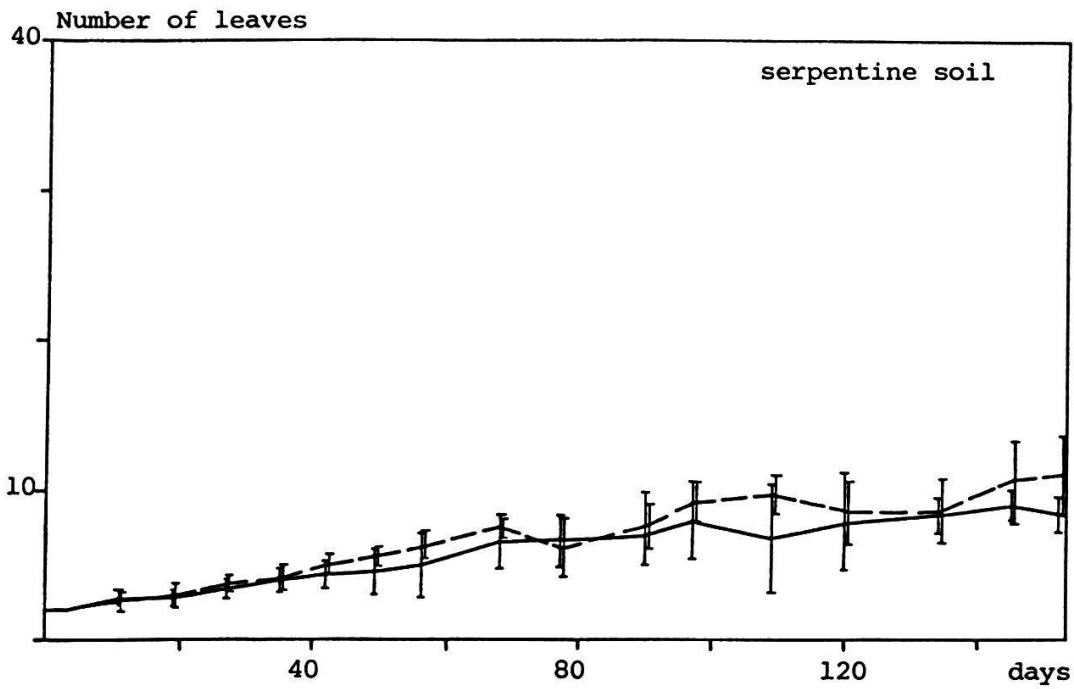
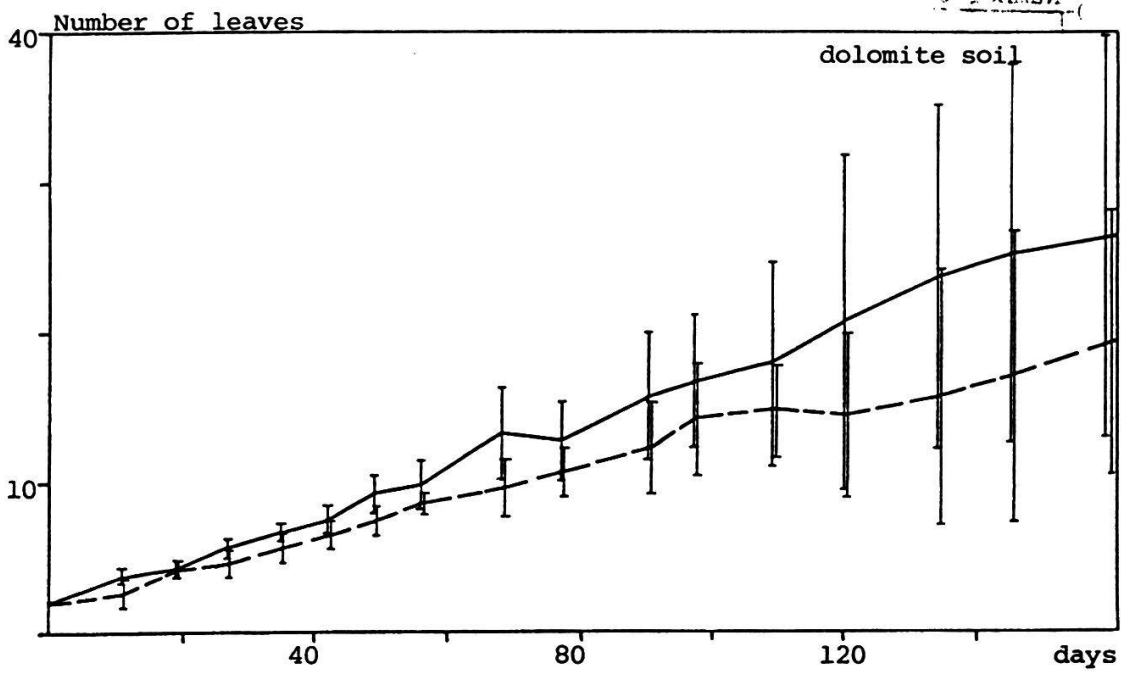

Figs 20,21. Greenhouse studies: Mean number of leaves ( $\pm$  S.D.) in 5 young plants from dolomite and from serpentine grown on dolomite and serpentine soil.

Abb. 20,21. Gewächshausversuche: Mittlere Anzahl Blätter ( $\pm$  s.) von 5 Jungpflanzen von Dolomit und von Serpentin gewachsen auf Dolomit- und auf Serpenterde.

dolomite ————— serpentine - - - - -

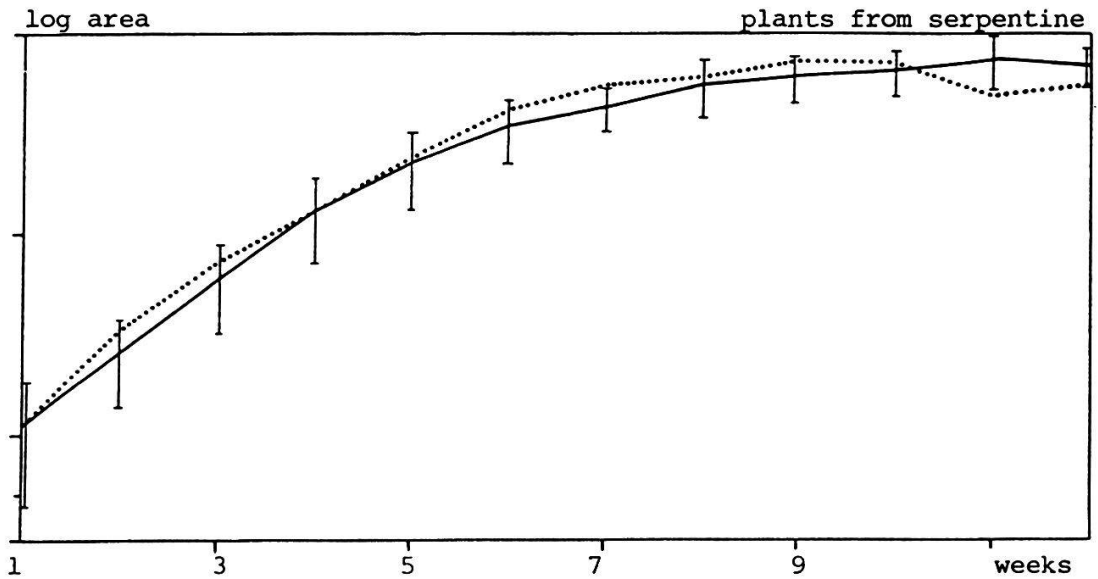
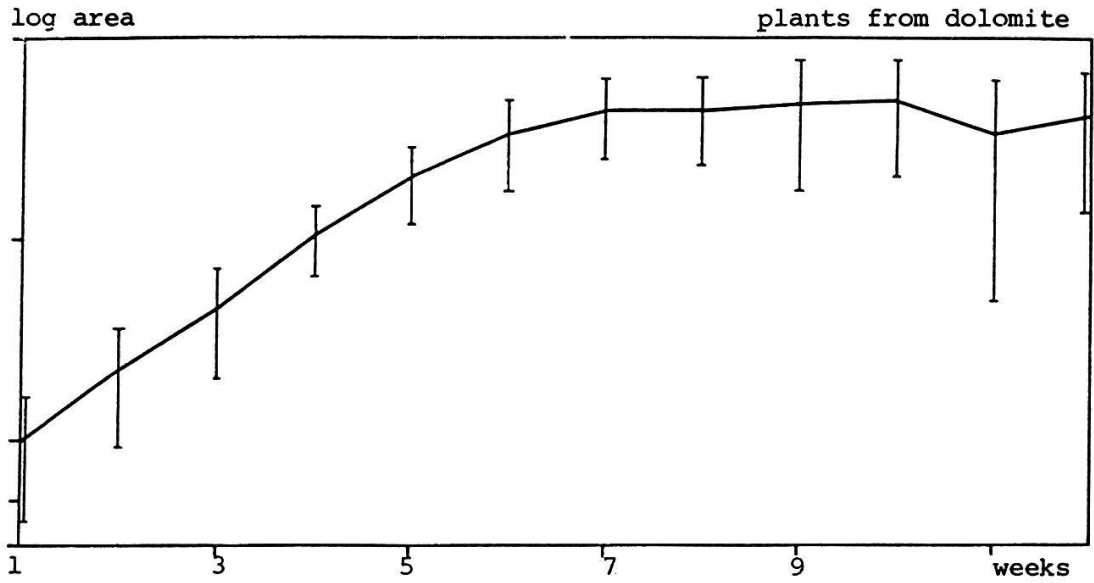

Figs 22,23. Greenhouse studies: Leaf area (length x width) ( $\pm$  S.D.) in 10 young plants from dolomite and from serpentine and in 2 plants from acidic silicate (dotted line) grown on garden soil.

Abb. 22,23. Gewächshausversuche: Blattfläche (Länge x Breite) ( $\pm$  s.) von 10 Jungpflanzen von Dolomit und von Serpentin und <sup>x</sup> von 2 Pflanzen von saurem Silikat gewachsen auf Gartenerde.

Table 10. Greenhouse studies: Development of young plants; analysis of variance of number of leaves.

Niveau of significance of differences between the substrata (dolomite and serpentine) used in the trials and origin of plants (dolomite and serpentine) are indicated.

Tab. 10. Gewächshausversuche: Entwicklung von Jungpflanzen, Varianzanalyse der Anzahl Blätter. Signifikanzniveau der Unterschiede zwischen den Substraten und den Herkünften sind angegeben.

- \*\* differences highly significant ( $P < .01$ )
- \* differences significant ( $.05 > P > .01$ )
- differences not significant ( $P > .05$ )

Days	0	11	19	27	35	42	49	56	68	77	90	109	120	134	145	153
Differences between substrata and origins	**	*	**	**	**	**	**	**	**	**	**	**	*	*	*	*
Differences between the substrata	-	-	**	**	**	**	**	**	**	**	**	**	**	**	**	**
Differences between the origins	**	-	-	-	-	-	-	-	-	-	-	-	-	-	-	-

The leaf area defined by length x width of leaves was determined in ten plants grown from seeds originating from dolomite, and in ten plants grown from seeds originating from serpentine. The leaf area in all series increased logarithmically during the first five to six weeks. Later on, the growth slowed down and eventually stopped (Figs 22,23); the mean leaf area of plants from dolomite even decreased. The pattern of development was quite similar in all series studied, no statistically significant differences being found in most cases. Two additional plants from acidic silicate showed the same tendencies.

Fresh weight of the whole plant (PW), and the number of rosettes (NR) were determined in 16 plants grown from seeds originated from dolomite and serpentine. 22-month-old plants grown from seeds originating from dolomite had a higher mean weight with a higher standard deviation than plants grown from seeds originating from serpentine. However, no statistically significant differences occurred between plants of different origins. Variation in the number of rosettes per plant and the ratio weight of plant / number of rosettes (PW/NR) followed the same pattern (Table 11).

Table 11. Greenhouse studies: Development of young plants grown on garden soil ( $\pm$  S.D.).

Tab. 11. Gewächshausversuche: Entwicklung der Jungpflanzen auf Gartenerde ( $\pm$  s<sub>x</sub>).

Origin of plants	DOL	SER
Weight of plant PW	15.8g $\pm$ 8.95g	12.6g $\pm$ 4.40g
N of rosettes NR	19 $\pm$ 17.2	8 $\pm$ 3.59
Ratio PW/NR	1.56 $\pm$ 1.25	1.71 $\pm$ .71

**Field observations.** The experimental plots were located both on developed soil as well as on scree. The percentages of germination on developed soil were nearly the same as those in the greenhouse. On dolomite soil, about 70% of the seeds from both dolomite and serpentine germinated within the first year, whereas on serpentine soil only about 35%

Table 12. Field observations: Minimal rates (%) of germination and mortality on developed soil. Beginning of trial: 7 Oct. 1980 (100 seeds per series) (substrata / origin of seeds).

Tab. 12. Feldversuche: Minimale Keimungsraten und Sterblichkeit auf entwickeltem Boden. (Substratum/Herkunft des Saatguts)  
DOL = dolomite, SER = serpentine

Year	DOL/DOL		DOL/SER		SER/DOL		SER/SER	
	germ.	dead	germ.	dead	germ.	dead	germ.	dead
1981	70	18.6	64	39.1	40	40.0	32	12.5
1982	84	33.3	71	66.2	41	63.4	34	17.6
1983	89	43.8	71	100	42	85.7	40	35.0
1984	89	58.4	71	100	42	95.2	41	39.0

Table 13. Field observations: Minimal rates (%) of germination and mortality on scree. Beginning of trial: 30 Sept. 1982 (50 seeds per series) (substrata / origin of seeds).

Tab. 13. Feldversuche: Minimale Keimungsraten und Sterblichkeit auf Schutt.  
DOL = dolomite, SER = serpentine

Year	DOL/DOL		DOL/SER		SER/DOL		SER/SER	
	germ.	dead	germ.	dead	germ.	dead	germ.	dead
1983	52.0	78.2	53.3	100	30.0	100	24.7	35.1
1984	57.3	75.6	53.3	100	30.0	100	28.7	74.4

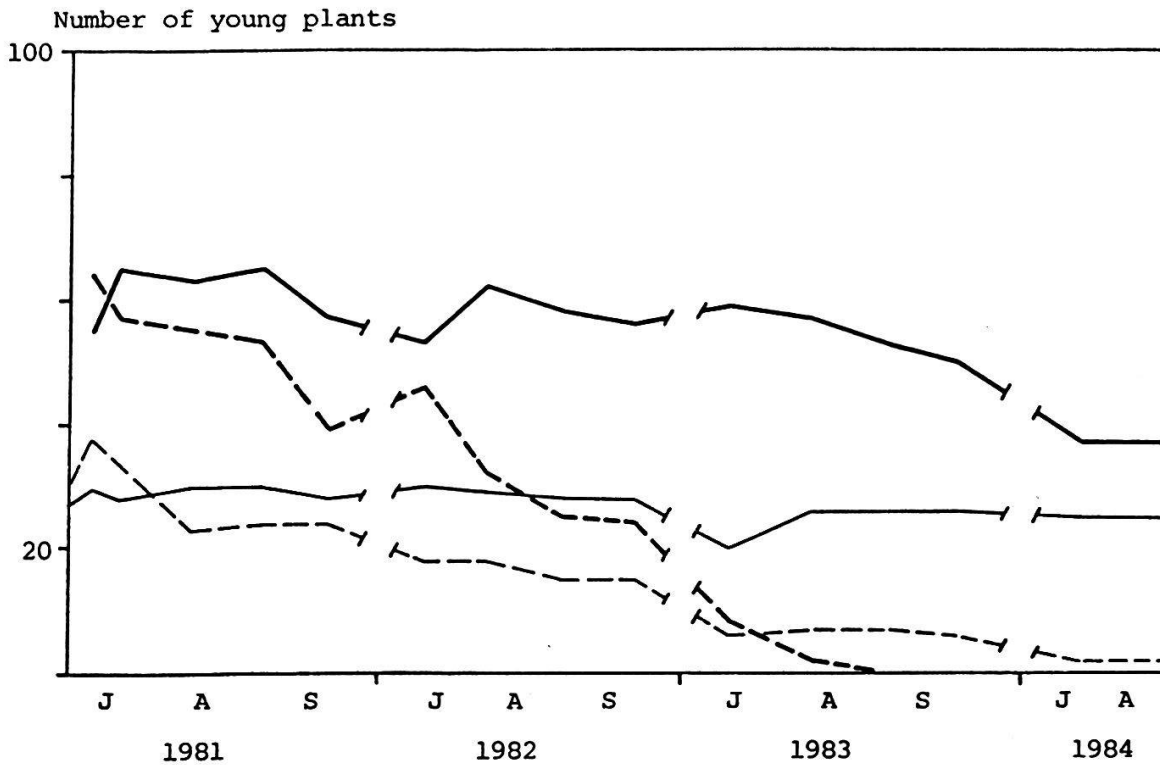

Fig. 24. Field observations: Net number of young plants from dolomite and serpentine grown on developed dolomite (solid line) and serpentine (dashed line) soil (100 seeds per series).

Abb. 24. Feldversuche: Nettoanzahl Jungpflanzen von Dolomit und Serpentin gewachsen auf entwickeltem Dolomit- und Serpentinboden.

Plants from dolomite: ———, — — —, Plants from serpentine: ———, — — —

did. In the following years, further seeds germinated (Table 12, Fig. 24).

The germination on scree plots was thus independent of the origin of the seeds. On the whole, germination on dolomite scree was much better than on serpentine. In addition, some differences in germination occurred between seeds from different local sectors (Table 13).

The mortality of seedlings and young plants grown on foreign substrata on developed soil was distinctly higher than that of plants grown on the substratum from which the seeds originated. After four consecutive seasons, all plants from serpentine on dolomite died, and only two plants from dolomite grown on serpentine were still alive (Table 12, Figs 25, 26). At the beginning, however, mortality rates were rather high in all series.

The mortality on scree plots was very pronounced from the very beginning of the trial; individuals growing on the foreign substratum never sur-



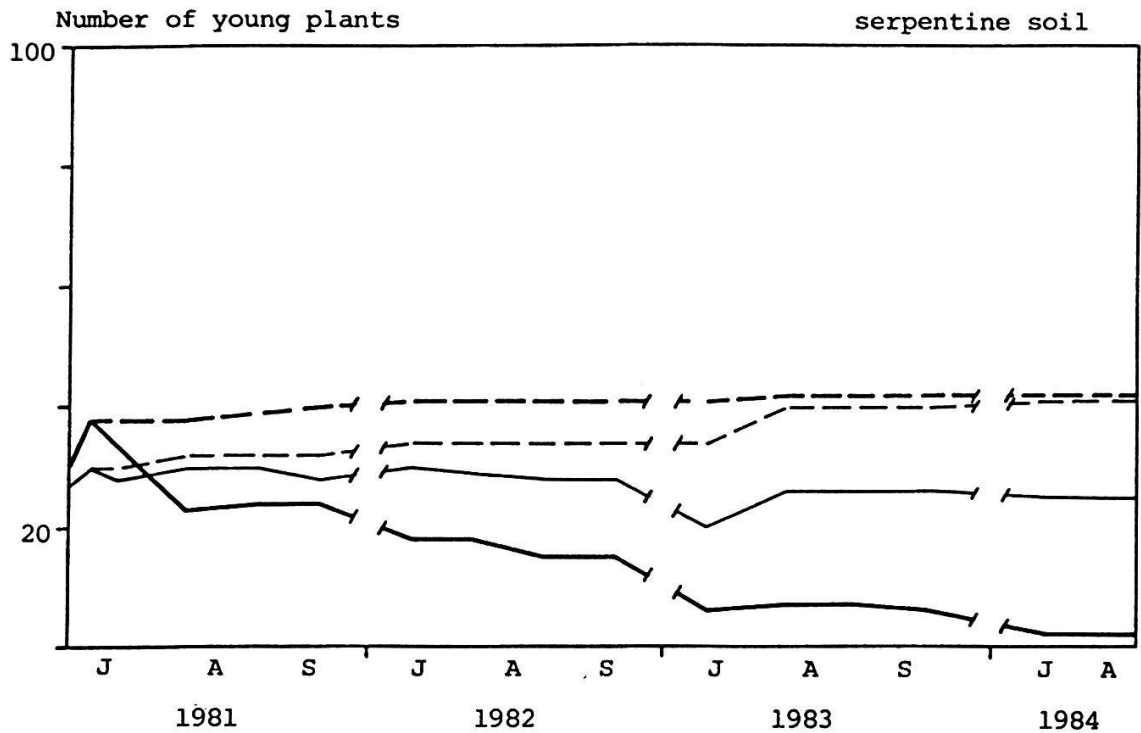
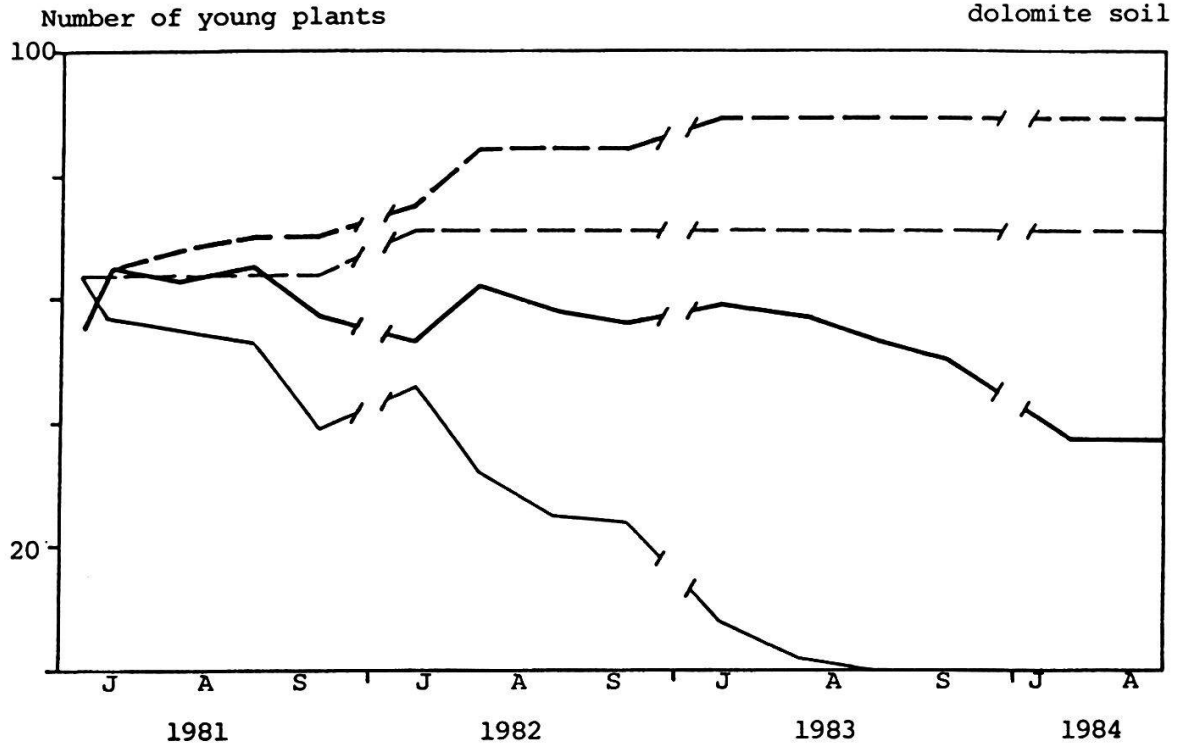

Figs 25,26. Field observations: Net numbers (solid line) and cumulative gains (dashed line) of young plants on developed dolomite and serpentine soil (100 seeds sown per series).

Abb. 25,26. Feldversuche: Nettoanzahl und kumulativer Zuwachs von Jungpflanzen von Dolomit und Serpentin, gewachsen auf entwickeltem Dolomit- und Serpentinboden.

Plants from dolomite: ———— ; - - - - -  
 Plants from serpentine: ———— ; - - - - -

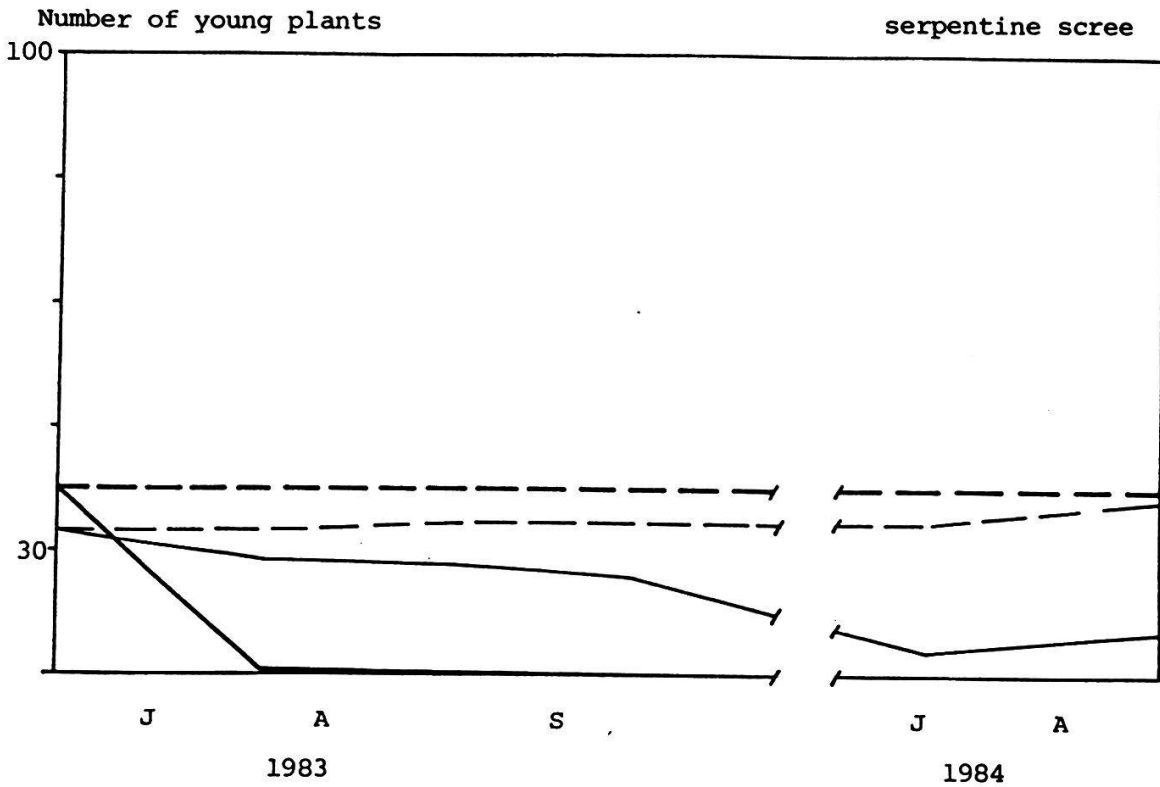
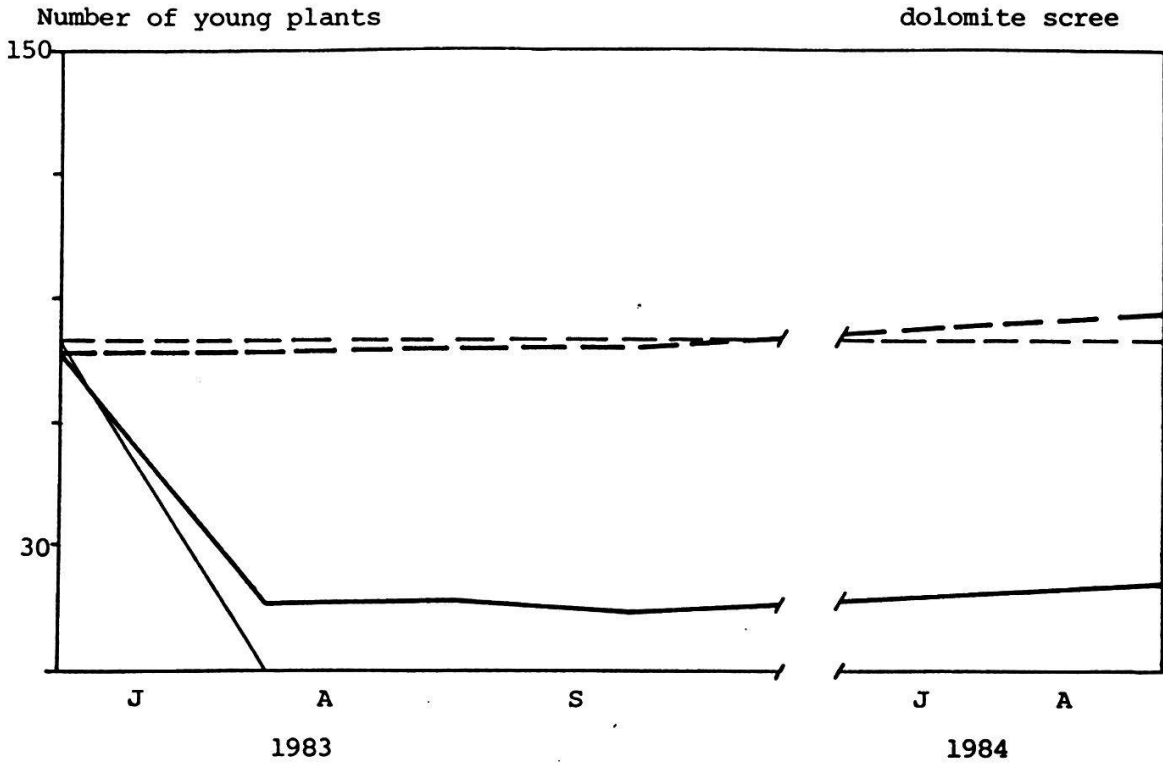

Figs 27,28. Field observations: Net numbers (solid line) and cumulative gains (dashed line) of young plants on dolomite and serpentine scree (150 seeds sown per series).

Abb. 27,28. Feldversuche: Nettoanzahl und kumulativer Zuwachs von Jungpflanzen von Dolomit und Serpentin, gewachsen auf Dolomit- und Serpentin schutt.

Plants from dolomite: ———, - - - , Plants from serpentine: ———, - - -

vived the seedling stage, whereas seedlings and young plants growing on the substratum of their origin died to 75%. All the seedlings originating from seeds harvested in the sector DOL 6 died immediately after germination (Table 13, Figs 27, 28).

Table 14. Field observations: Development of seedlings and young plants on developed soil (substrata / origin of seeds).

Tab. 14. Feldversuche: Entwicklung der Keimlinge und Jungpflanzen auf entwickeltem Boden.

N = number of leaves - Anzahl Blätter; h = height - Höhe

d = diameter of rosettes in mm - Durchmesser der Blattrosetten in mm

DOL = dolomite, SER = serpentine

Scored on	DOL/DOL			DOL/SER			SER/DOL			SER/SER		
	N	h	d	N	h	d	N	h	d	N	h	d
5 July 81	5	5	13	3	5	10	4	5	10	4	5	11
1 Sept 81	5	15	16	4	10	12	5	5	10	4	5	12
26 Sept 81	5	20	20	5	10	10	4	5	10	4	10	13
5 July 82	7	20	20	5	13	7	6	10	20	6	20	20
31 July 82	5	20	20	4	12	7	7	10	20	6	40	20
30 Aug 82	6	25	20	5	10	10	6	10	15	6	35	40
28 Sept 82	8	30	20	8	5	7	7	5	15	7	30	30
6 July 83	9	25	20	8	10	8	7	15	20	6	20	15
8 Aug 83	6	30	25	4	10	10	7	20	20	7	30	50
6 Oct 83	6	30	30	-	-	-	2	5	10	6	30	30
1 Sept 84	15	70	70	-	-	-	5	30	15	10	100	50

Table 15. Field observations: Development of seedlings and young plants on scree soil (substrata / origin of seeds).

Tab. 15. Feldversuche: Entwicklung der Keimlinge und Jungpflanzen auf Schutt.

(For abbreviations see Table 24 - Abkürzungen s. Tab. 14)

Scored on	DOL/DOL			SER/SER		
	N	h	d	N	h	d
6 July 83	2	5	10	2	5	8
8 Aug 83	4	5	10	4	5	8
7 Sept 83	4	7	13	4	7	15
6 Oct 83	6	10	15	4	10	15
25 July 84	6	12	15	6	15	15
1 Sept 84	7	25	15	6	30	15

The statistical treatment of the data revealed that germination in the field was significantly dependent on the substratum ( $P < .01$ ) and not on the origin of the seeds, whereas the mortality was significantly influenced by both substratum and origin ( $P < .01$ ).

Accumulation of the biomass at early life phases was assessed by the number of leaves, height, and diameter of the rosettes of the best developed plants within each series.

In the first season, there were only few differences between all series, plants grown on developed dolomite soil from seeds originating from dolomite being best developed. In the second season, the development of plants growing on foreign substratum was clearly slower; on the other hand, no distinct differences were observed between plants growing on developed soil and on scree. In the third and fourth season, the advantages of plants growing on the substratum of their origin became more and more evident (Tables 14, 15); a single four-year-old plant originating from a seed from serpentine and growing on developed serpentine soil even flowered.

### 3.2.3. Transplantations in the field

The success of transplanted rosettes was determined by their vitality. Green rosettes, reproducing rosettes, and plants surviving the transplantation though not necessarily having green rosettes were noted during each census.

The percentage of individuals surviving the transplantations on dolomite soil was generally low. Distinct differences were observed between plants from various sectors within a given substratum (Table 16). The percentages of survivors were clearly higher on serpentine, where plants originating from dolomite performed better than the controls. The differences between material originating from the same substratum were negligible. The generally lower percentages of survivors on dolomite might be explained by the much higher density of vegetation.

In transplantations on dolomite, the number of green rosettes decreased from census to census, without regard to the origin of transplanted material. A few rosettes were reproducing in 1983, but in 1984 no reproducing plants were observed (Fig. 29).

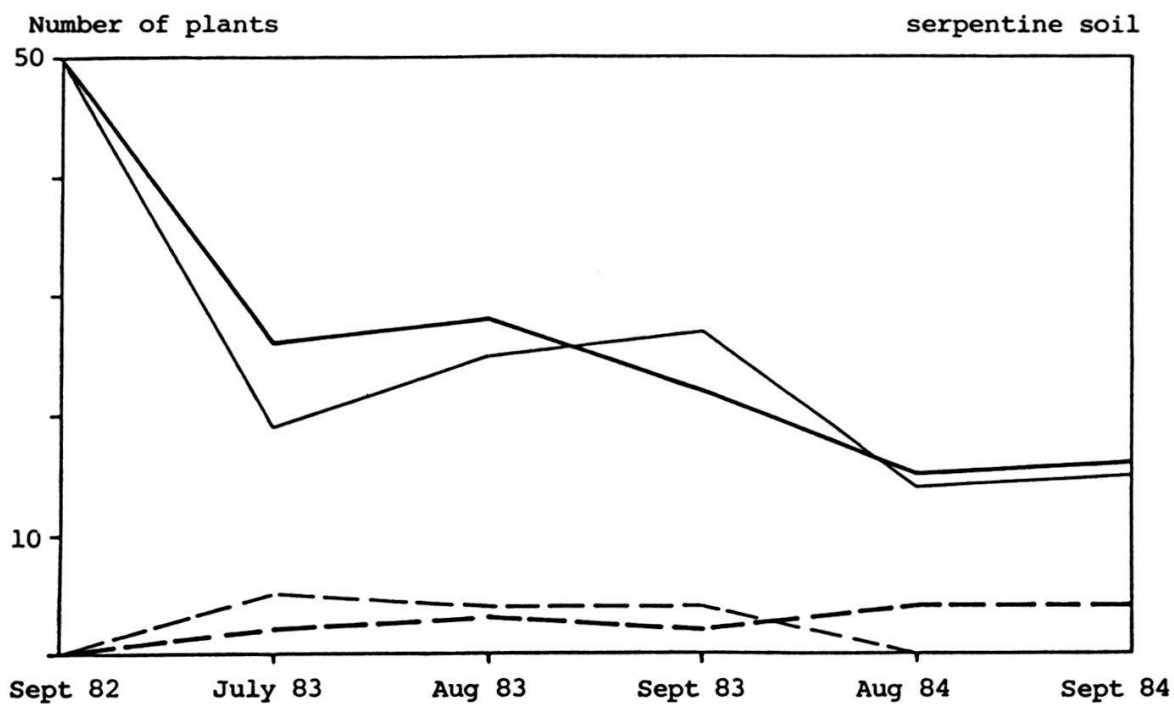
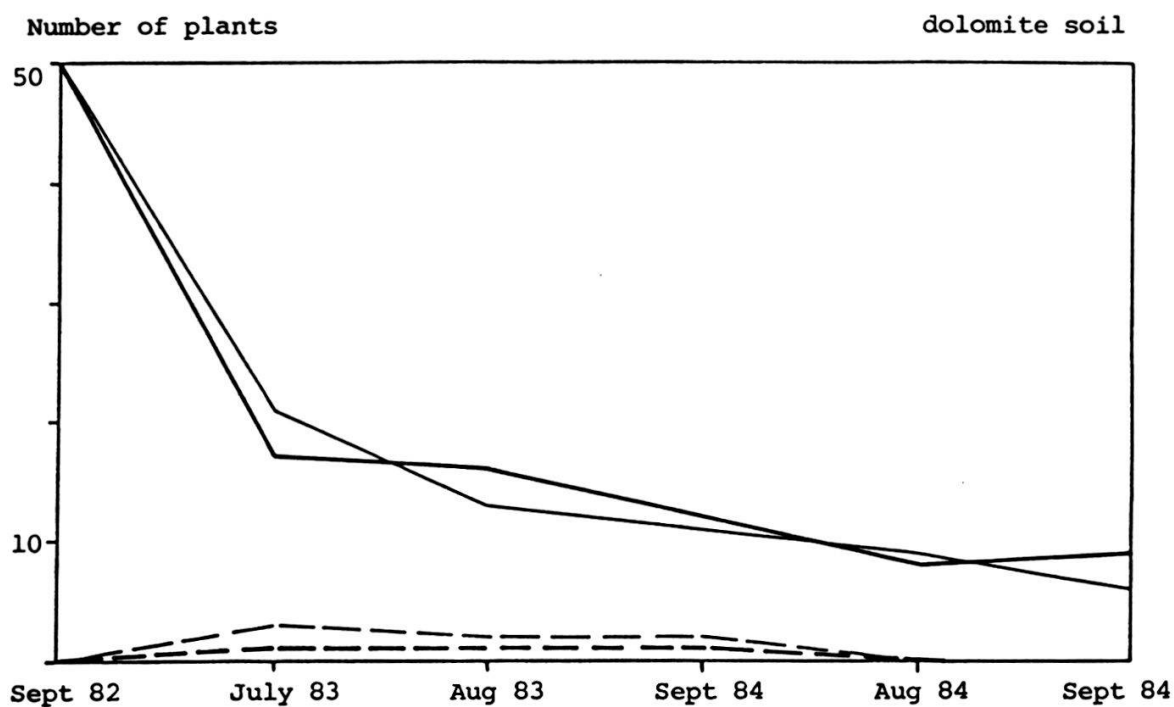

Figs 29,30. Transplantations: Number of plants with green rosettes (solid line) and number of plants with reproducing rosettes (dashed line) on dolomite and serpentine soil (50 plants per series).

Abb. 29,30. Verpflanzungen: Anzahl Pflanzen mit grünen Rosetten und Anzahl Pflanzen mit Blütenständen.

Plants from dolomite: ———, — — —, Plants from serpentine: ———, — — —

Table 16. Transplantations: Establishment (%) (25 plants per series).  
Tab. 16. Verpflanzungen: Etablierung.

DOL = dolomite, SER = serpentine.

Substratum	Origin of plants			
	DOL 7	DOL 8	SER 2,4,5	SER 3,7
	38		42	
Dolomite	48	28	32	52
	76		60	
Serpentine	80	72	56	64

The behaviour of transplanted individuals on serpentine was rather erratic e.g. some plants found dormant during the first census had green leaves in a later census. Reproducing plants were more frequent on serpentine than on dolomite; also in this respect individuals from dolomite performed better than serpentine plants (Fig. 30).

The transplantation experiments show that the behaviour of plants was influenced both by the substratum as well as the origin of the material.

#### 4. DEMOGRAPHIC STUDIES

##### 4.1. METHODS

In sites where Biscutella levigata was particularly abundant, two 1 m<sup>2</sup> plots codified as A and B were selected within each population sector (Fig. 1). They were permanently marked with plugs. The plots were mapped once a month in July, August, and September; not all plots could be mapped at each monthly census (Table 17) on account of the snow cover lasting longer than usual in the spring, as well as of an intermittent snowfall during the vegetation season.

Three different age-state variants sensu RABOTNOV (1978) were distinguished:

**Seedlings.** (Fig. 31, codified as S). The seedlings were first identified by their cotyledons. Young plants were named seedlings during the whole first season of their life, even if they subsequently lost their cotyledons.

**Non-reproducing rosettes.** (Fig. 31, codified as N). All rosettes without inflorescences notwithstanding their real age were included in this category.

**Reproducing rosettes.** (Fig. 31, codified as R). This category comprised all rosettes with inflorescences disregarding their chronological age. Without destroying the plots it could not be decided, whether the rosettes originated from various seeds or root suckers. For this reason, all rosettes were considered as ramets, only the seedlings and the subsequently developing young plants being recognized as genets i.e. distinct genotypes.

Special attention was paid to various reproductive phases occurring in a given reproducing rosette. The following reproductive units were taken into consideration:

- flower buds
- flowers
- unripe fruits
- ripe fruits
- seeds.

An aluminium frame (1 m x 1 m) divided into 100 1 dm<sup>2</sup> squares by an elastic cord was used during each census. The number of all age-state variants and reproductive units was exactly determined in each of the small squares per plot.



Fig. 31. Age-state variants of Biscutella levigata (after GASSER 1983).  
Abb. 31. Altersvarianten von Biscutella levigata

S = Seedlings - Keimlinge

N = Non-reproducing rosettes - Nichtreproduzierende Rosetten

R = Reproducing rosettes - Reproduzierende Rosetten



The raw data (number of genets, ramets, and reproductive units per 1 dm<sup>2</sup>) was stored in a computer; all further calculations were made by computer. Most programs used were produced by the author and they are stored at the Geobotanical Institute.

#### 4.1.1. Spatial distribution

To assess the distribution pattern of Biscutella levigata in the plots studied, the sum of all age-state variants was used (seedlings, non-reproducing, and reproducing rosettes). The following parameters were calculated:

$$\text{Density} = \frac{N}{100} = \frac{\text{total number of plants per m}^2}{\text{total number of small quadrats}}$$

$$\text{Abundance} = \frac{N}{Q} = \frac{\text{total number of plants per m}^2}{\text{total number of occupied small quadrats}}$$

The abundance is the measure of density in the patches.

$$\text{Index of dispersion} = \frac{\text{variance}}{\text{mean}}$$

$$\text{variance} = s^2 = \frac{\text{sum of } (x_i - xq)^2}{\text{number of sub-plots} - 1}$$

where  $x^i$  is the number of plants in the  $i$ -th sub-plot

$$\text{mean} = xq = \frac{\text{total number of plants per m}^2}{\text{number of sub-plots}}$$

The index of dispersion was calculated for four different sub-plots codified in Fig. 32:

- a. 1 dm<sup>2</sup> sub-plot
- b. 4 dm<sup>2</sup> sub-plot
- c. horizontal column sub-plot
- d. vertical column sub-plot.

If the distribution was mosaic-like ("contagious" sensu GREIG-SMITH 1983), random, or regular, significance was assessed by reference to the table of  $\chi^2$ . For detailed descriptions, the reader is referred to GREIG-SMITH (1983).

For comparison, the same parameters were calculated separately for each given age-state variant. If many individuals per  $m^2$  were observed, index of dispersion was calculated for  $1 \text{ dm}^2$ ; if there were only a few individuals, index of dispersion was calculated for  $4 \text{ dm}^2$ .

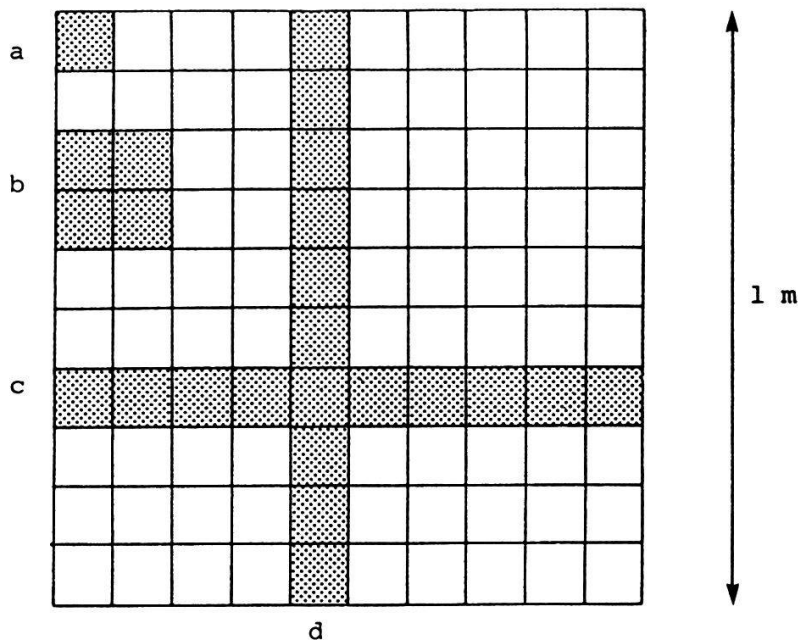

Fig. 32. Four different sub-plots used for calculation of index of dispersion. Explanations see text.

Abb. 32. Die vier verschiedenen Teilflächen, die für die Berechnung des Dispersionsindex verwendet wurden.

#### 4.1.2. Temporal distribution

The evaluation of behaviour of genets was based upon data collected in 1982, 1983, and 1984 (Table 17). In order to recognize seedlings they were marked individually with a thread, a different colour being used for each year. The number of seedlings counted in July 1982 was considered as 100% and the subsequent gains and losses were calculated as percentages of this. The fate of young genets was followed for a maximum of three seasons.

To assess the behaviour of ramets viz. non-reproducing and reproducing rosettes during one vegetation season the census data of 1983 were taken, and the net number of rosettes as well as cumulative gains and losses were calculated.

The behaviour over several years is represented by the sum of the age-state variants per one m<sup>2</sup> plot and based on the data gathered during the August census of 1982, 1983, and 1984. If a 1 m<sup>2</sup> plot was not scored in August, the data obtained at the end of July or beginning of September were taken into consideration. Gains and losses over several years were not calculated, because the number of ramets dying during the winter could not be observed.

Table 17. Demographic census in different plots.

Tab. 17. Kontrollen der verschiedenen Flächen.

J = July, A = August, S = September

DOL = dolomite, SER = serpentine, SIL = acidic silicate

Plot code	Census											
	1981			1982			1983			1984		
	J	A	S	J	A	S	J	A	S	J	A	S
DOL 1A	+	+	+	+	+	+	+	+	+	+		+
1B				+	+	+	+	+	+	+		+
DOL 2A					+	+	+	+	+	+		+
2B					+	+	+	+	+	+		+
DOL 3A					+	+	+	+	+			+
3B					+	+	+	+	+			+
DOL 4A	+	+	+	+	+	+	+	+	+	+		+
4B	+	+	+	+	+	+	+	+	+	+		+
DOL 5A	+	+	+	+	+	+	+	+	+	+		+
5B		+	+	+	+	+	+	+	+	+		+
DOL 6A	+	+	+	+	+	+	+	+	+	+		+
6B	+	+	+	+	+	+	+	+	+	+		+
DOL 7A					+	+	+	+	+			+
7B					+	+	+	+	+			+
DOL 8A	+	+	+	+	+	+	+	+	+			+
8B	+	+	+	+	+	+	+	+	+			+
DOL 9A					+	+	+	+	+			+
9B					+	+	+	+	+			+
DOL 10A					+	+	+	+	+			+
10B					+	+	+	+	+			+
DOL 11A					+	+	+	+	+			+
11B					+	+	+	+	+			+
DOL 12A		+	+	+	+	+	+	+	+			+
12B					+	+	+	+	+			+

Table 17. (continued)

Plot code	Census											
	1981			1982			1983			1984		
	J	A	S	J	A	S	J	A	S	J	A	S
SER 1A	+	+		+	+	+	+	+	+		+	+
1B		+	+	+	+	+	+	+	+		+	+
SER 2A				+		+	+	+	+	+		+
2B				+		+	+	+	+	+		+
SER 3A				+		+	+	+	+		+	
3B				+		+	+	+	+		+	
SER 4A	+	+	+	+	+	+	+	+	+	+		+
4B				+		+	+	+	+	+		+
SER 5A	+	+	+	+	+	+	+	+	+		+	
5B				+		+	+	+	+		+	
SER 6A	+	+	+	+	+	+	+	+	+		+	+
6B		+	+	+	+	+	+	+	+		+	+
SER 7A				+		+	+	+	+		+	
7B				+		+	+	+	+		+	
SER 8A	+	+	+	+	+	+	+	+	+	+		+
8B	+	+	+	+	+	+	+	+	+	+		+
SER 9A	+	+	+	+	+	+	+	+	+	+		+
9B	+	+	+	+	+	+	+	+	+	+		+
SER 10A				+		+	+	+	+		+	
10B				+		+	+	+	+		+	
SER 11A		+	+	+	+	+	+	+	+		+	
11B				+		+	+	+	+		+	
SIL A				+		+	+	+	+		+	
B				+		+	+	+	+		+	

In the assessment of the behaviour of the reproductive units, the data of 1983 were used.

## 4.2. RESULTS

### 4.2.1 Spatial distribution

Global evaluations for all age-state variants. Three-dimensional representations of distribution pattern of Biscutella levigata are exemplified by DOL 1A, a plot in dolomite grassland, and SER 8A, a serpentine plot

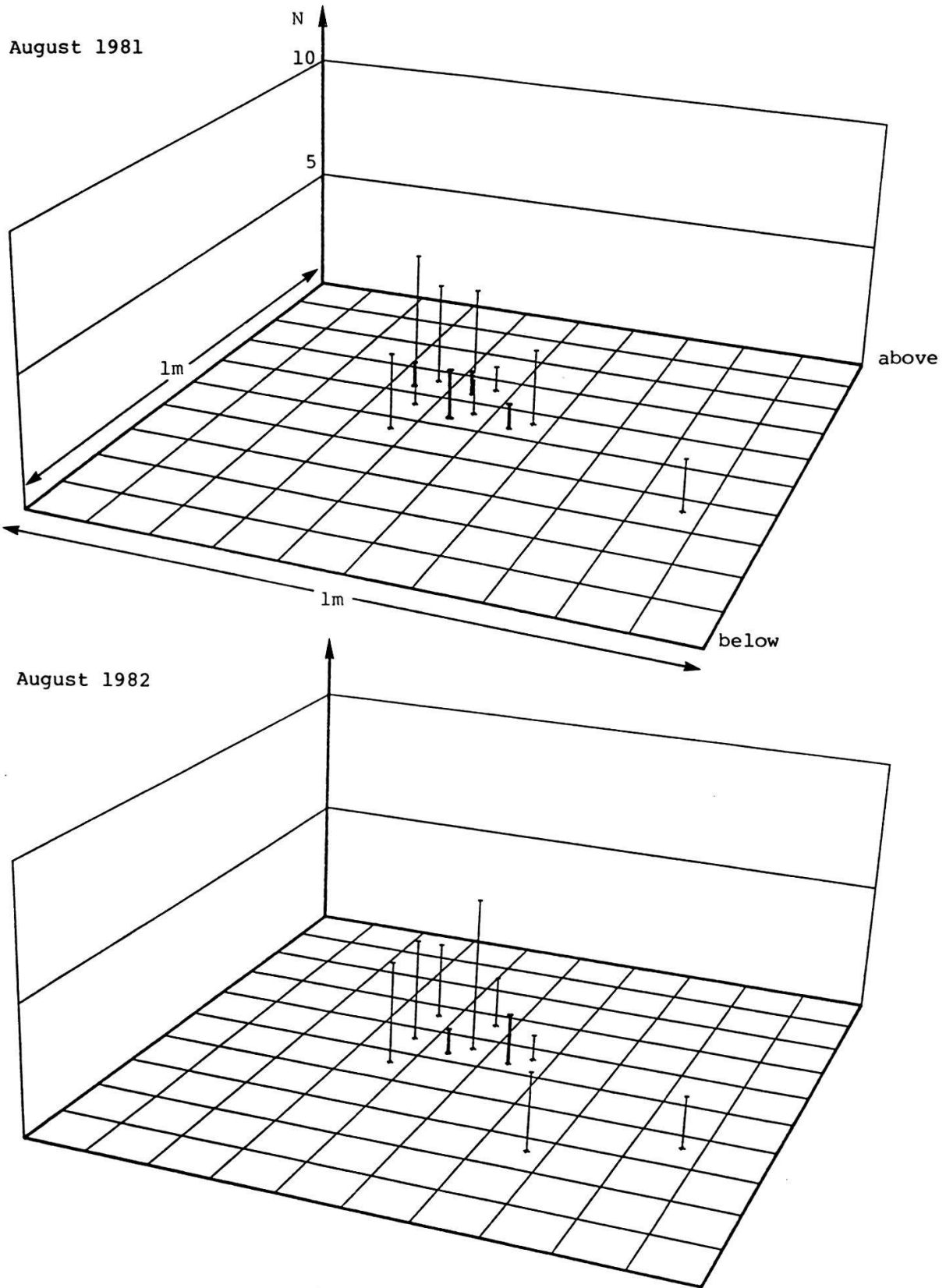
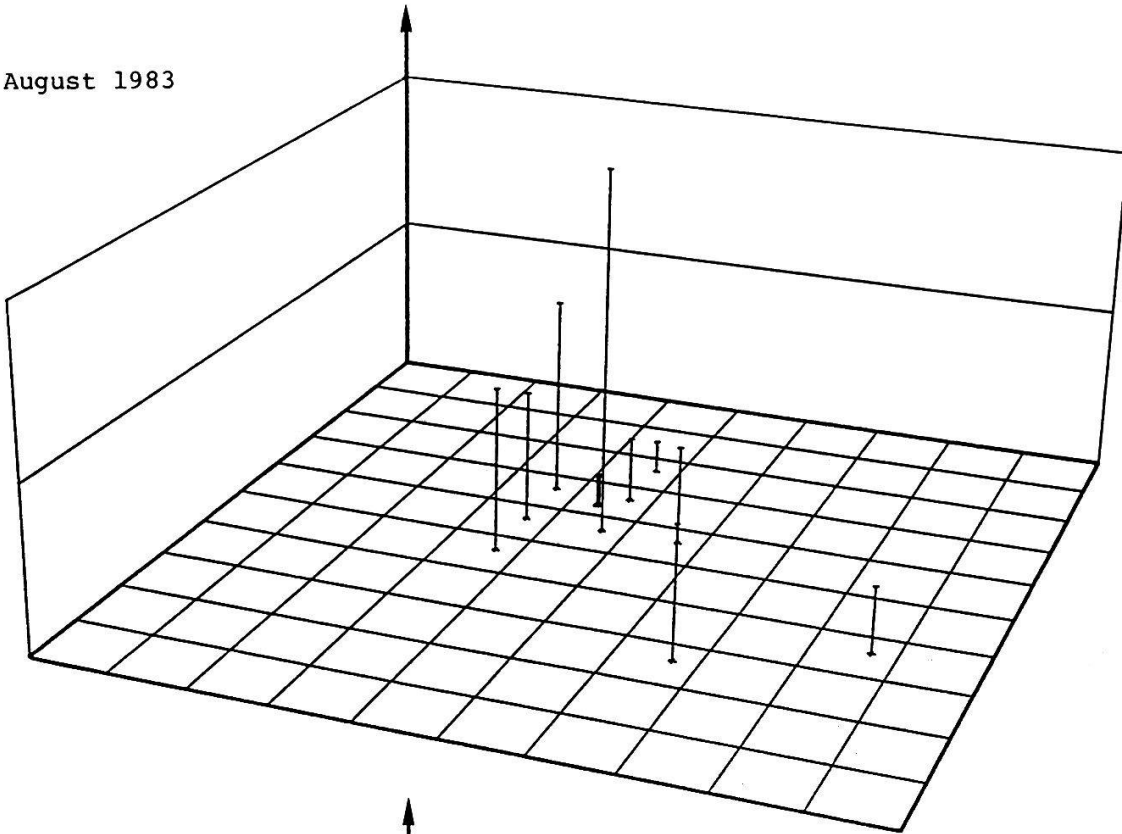

Fig. 33. Distribution pattern of the age-state variants of B. levigata in DOL 1A over 4 years.

Abb. 33. Verteilungsmuster der Altersvarianten von B. levigata in DOL 1A während 4 Jahren.

August 1983



August 1984

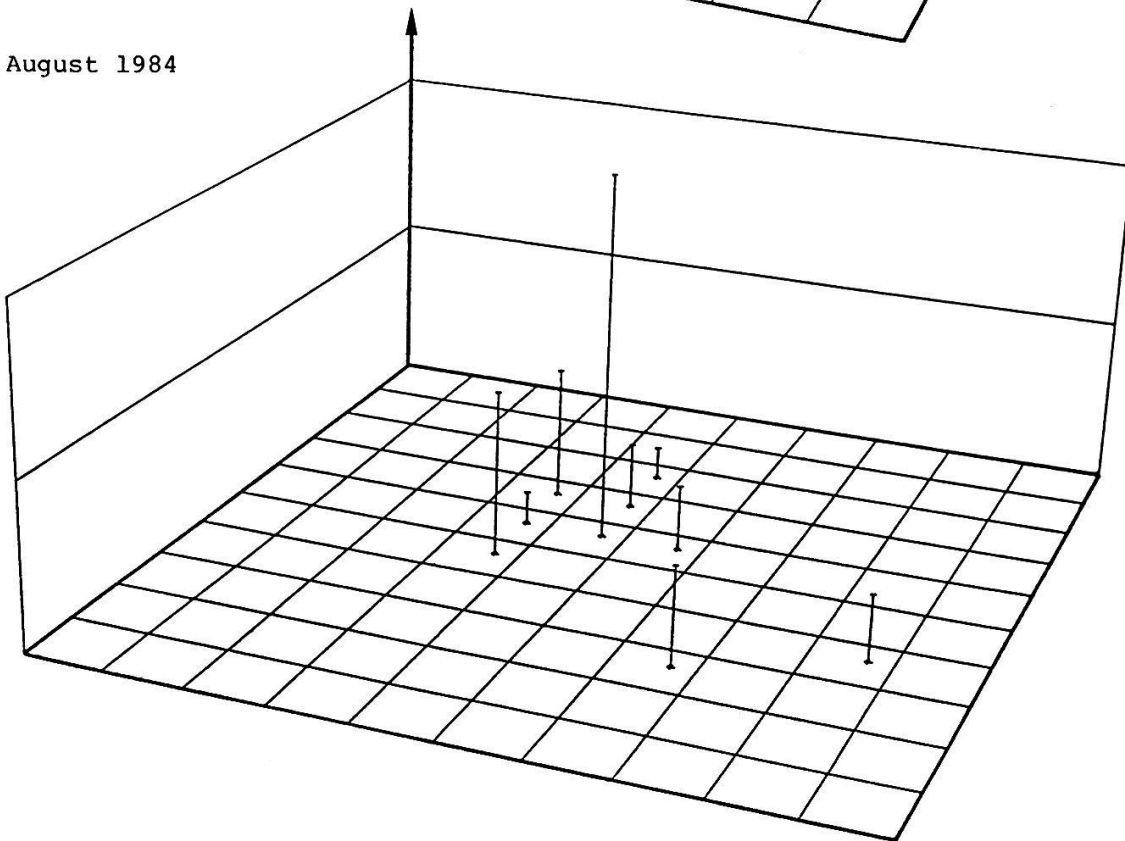

Fig. 33 (continued)

- ..... Seedlings - Keimlinge
- Non-reproducing rosettes - Nichtreproduzierende Rosetten
- Reproducing rosettes - Reproduzierende Rosetten

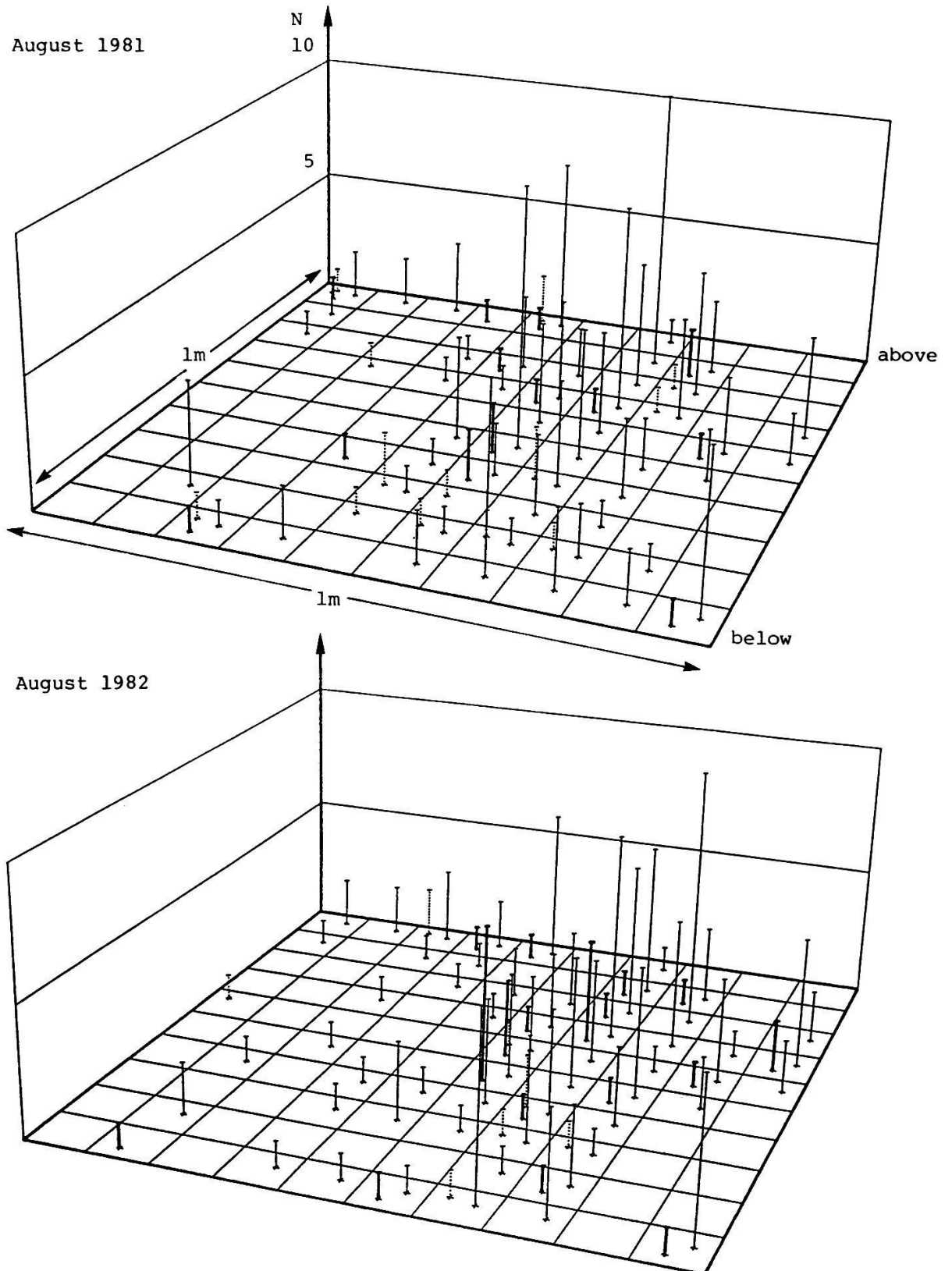
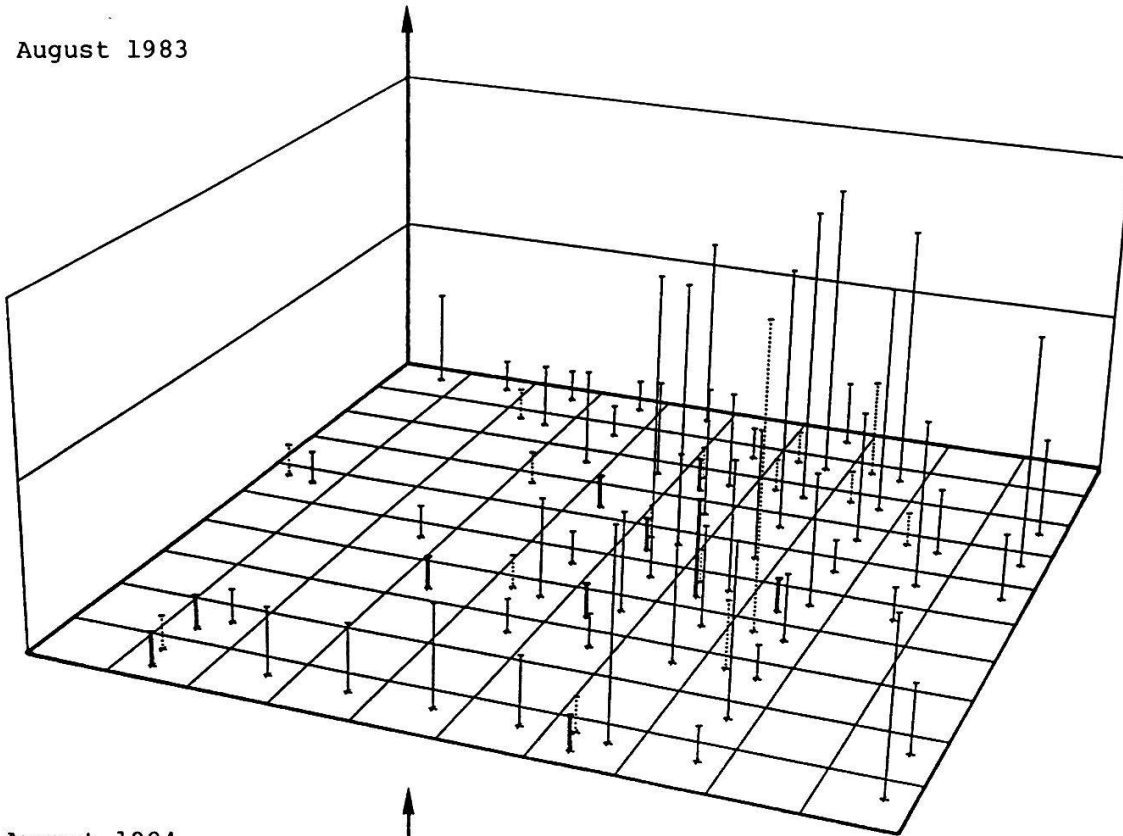

Fig. 34. Distribution pattern of the age-state variants of B. levigata in SER 8A over 4 years.

Abb. 34. Verteilungsmuster der Altersvarianten von B. levigata in SER 8A während 4 Jahren.

August 1983



August 1984

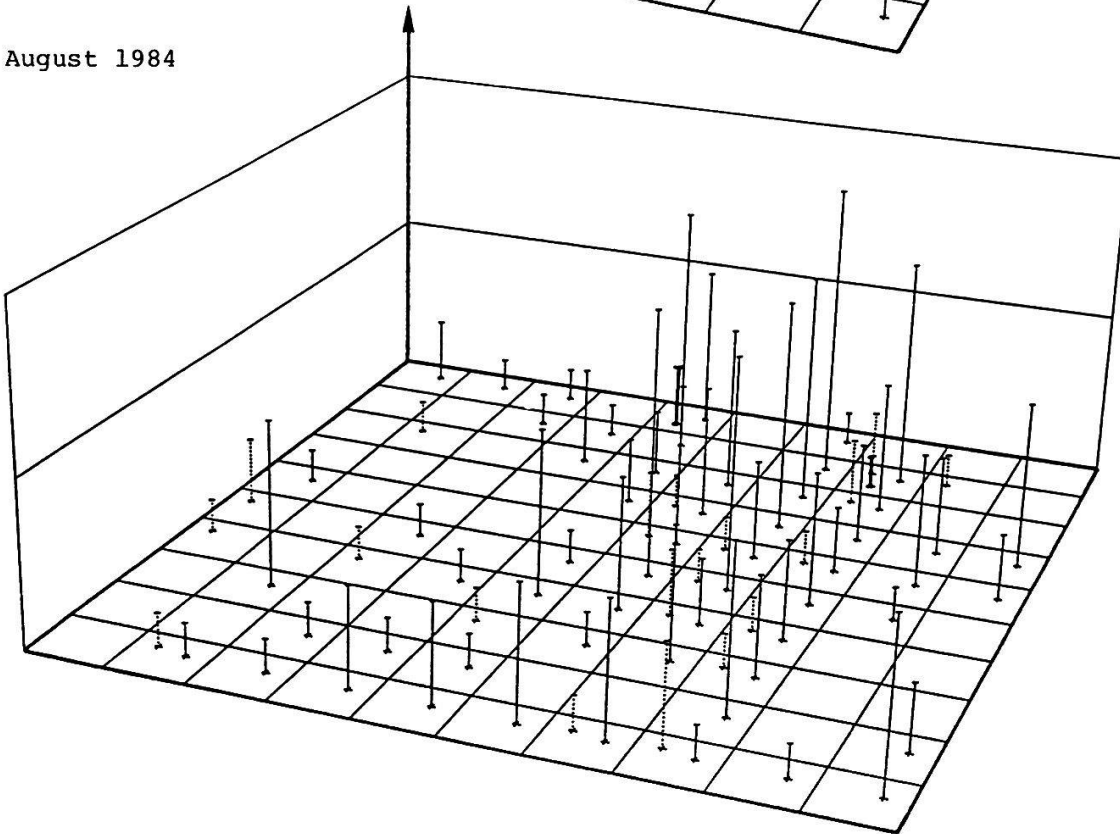
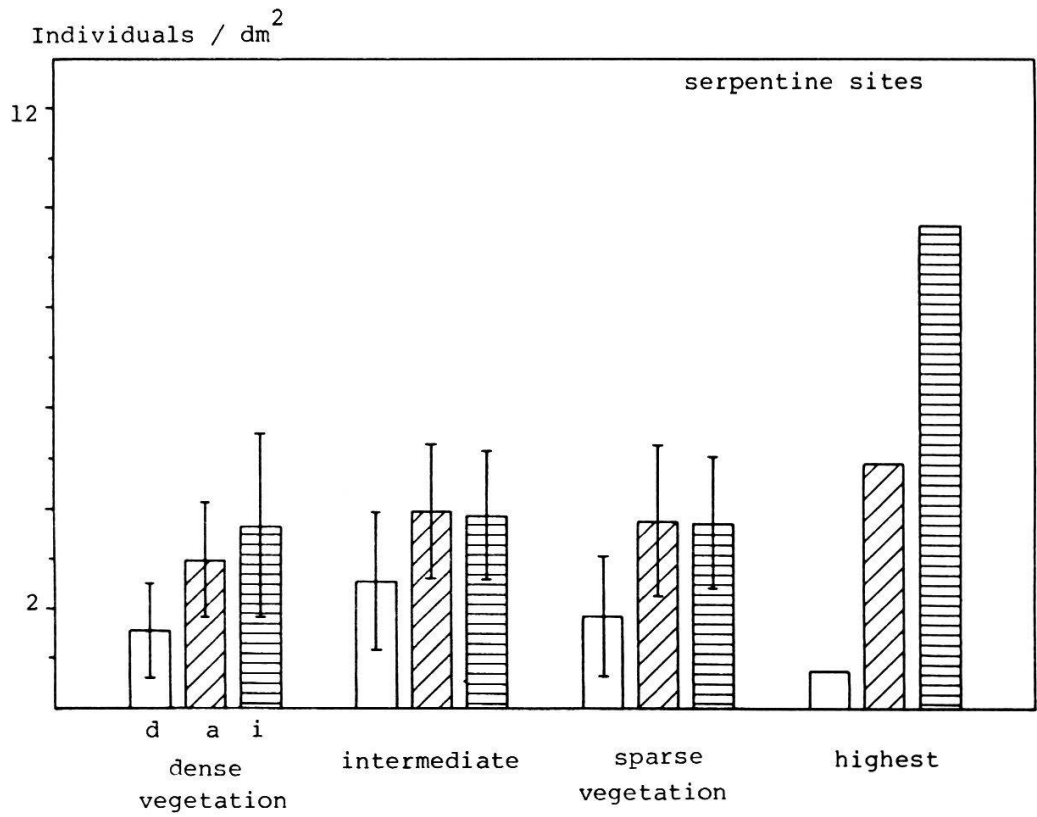
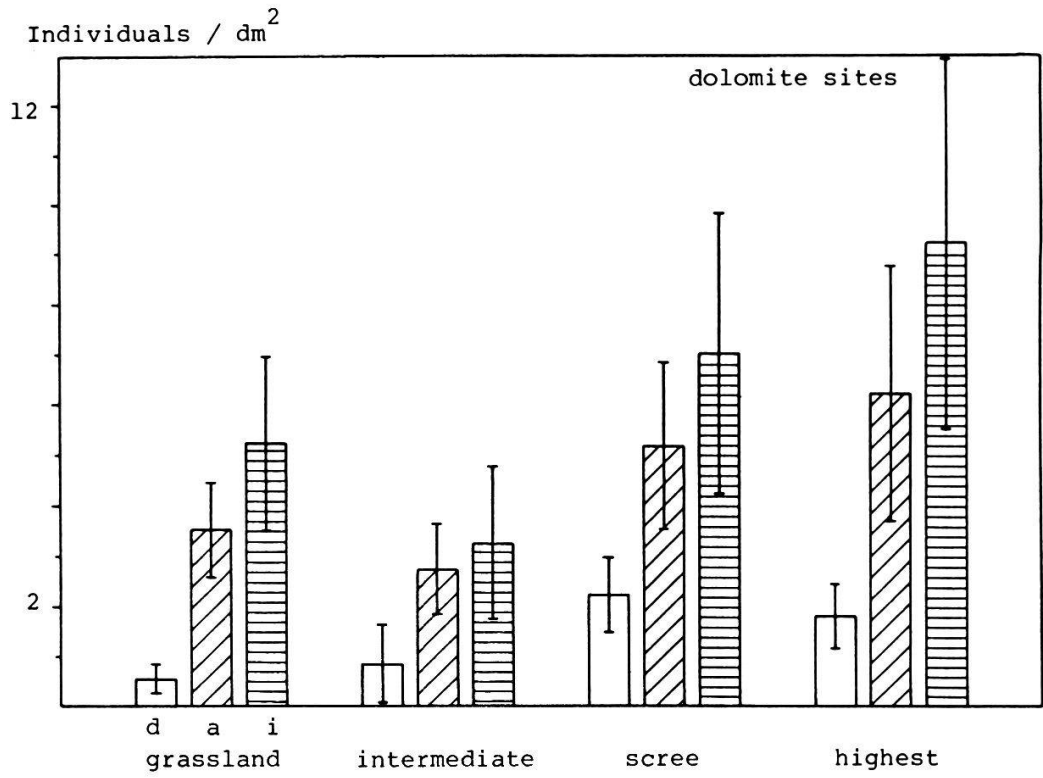

Fig. 34 (continued)

- ..... Seedlings - Keimlinge
- Non-reproducing rosettes - Nichtreproduzierende Rosetten
- Reproducing rosettes - Reproduzierende Rosetten





with thin vegetation (Figs 33, 34). As far as the density is concerned, distinct differences occurred between particular local sectors on dolomite (Table 18, Fig. 35). In grassland, a low density was observed whereas many more individuals per area were found on scree slopes. Large fluctuations from plot to plot were observed in intermediate and highest sectors. The differences between the niches were statistically signifi-

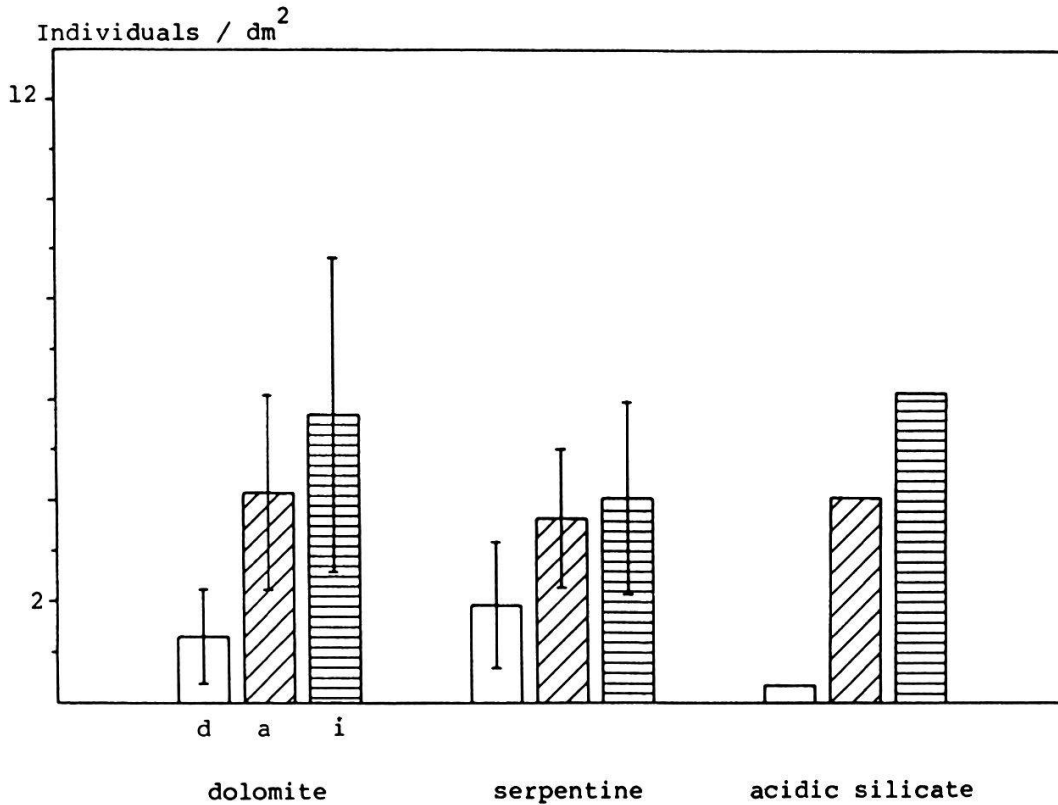

Fig. 37. Global evaluations of density (d), abundance (a), and index of dispersion (i) ( $\pm$  S.D.) of all three age-state variants on dolomite, serpentine, and acidic silicate. Census of August 1983.

Abb. 37. Dichte (d), Abundanz (a) und Dispersionsindex (i) ( $\pm$  s.) von den drei Altersvarianten auf Dolomit, Serpentin und <sup>x</sup>saurem Silikat. Zählung vom August 1983.

Figs 35,36. (p. 58). Global evaluations of density (d), abundance (a), and index of dispersion (i) ( $\pm$  S.D.) of all three age-state variants on various sites on dolomite and serpentine. Census of August 1983.

Abb. 35,36. (S. 58). Dichte (d), Abundanz (a) und Dispersionsindex (i) ( $\pm$  s.) von den drei Altersvarianten auf den verschiedenen Dolomit- und Serpentinflächen. Zählung vom August 1983.

Table 18. Global evaluations of density, abundance, and index of dispersion ( $\pm$  S.D.) of all three age-state variants. Census of August 1983.

Tab. 18. Dichte, Abundanz und Dispersionsindex ( $\pm$  s<sub>x</sub>) von den drei Altersstadien. Zählung vom August 1983.

Site	Dolomite	Serpentine
	Density	
	Individuals / dm <sup>2</sup>	
grassland / dense veg.	0.56 $\pm$ 0.30	1.56 $\pm$ 0.98
intermediate	0.89 $\pm$ 0.86	2.56 $\pm$ 1.39
scree / sparse veg.	2.28 $\pm$ 0.74	1.84 $\pm$ 1.22
highest	1.82 $\pm$ 0.65	0.74
all sectors	1.31 $\pm$ 0.96	1.92 $\pm$ 1.25
acidic silicate	0.37	
	Abundance	
	Individuals / dm <sup>2</sup>	
grassland / dense veg.	3.53 $\pm$ 0.95	2.98 $\pm$ 1.16
intermediate	2.77 $\pm$ 0.91	3.96 $\pm$ 1.36
scree / sparse veg.	5.20 $\pm$ 1.68	3.75 $\pm$ 1.49
highest	6.25 $\pm$ 2.57	4.91
all sectors	4.15 $\pm$ 1.94	3.67 $\pm$ 1.34
acidic silicate	4.07	
	Index of dispersion	
	(1 dm <sup>2</sup> )	
grassland / dense veg.	5.26 $\pm$ 1.72	3.68 $\pm$ 1.88
intermediate	3.26 $\pm$ 1.51	3.88 $\pm$ 1.30
scree / sparse veg.	7.02 $\pm$ 2.80	3.71 $\pm$ 1.31
highest	9.29 $\pm$ 3.75	9.67
all sectors	5.71 $\pm$ 3.12	4.05 $\pm$ 1.89
acidic silicate	6.19	

cant ( $P < 1\%$ , Table 22). On serpentine, *B. levigata* grew more densely but no significant differences as compared to dolomite were calculated (Figs 36, 37). Owing to great fluctuations, no significant differences between the niches were observable within all serpentine sectors. The two plots studied from silicate corresponded to the lowest densities found in the course of the present study (Fig. 37).

The abundance in all sectors was distinctly higher than the density notwithstanding the substrata. In grassland and on scree slopes the abundance was higher than on the intermediate and on the highest sectors. The differences between the niches were significant upon dolomite ( $P < 1\%$ ). On the other hand, no significant differences between the niches were observed on serpentine (Tables 18, 22, Fig. 36). The differences between dolomite and serpentine were also not significant. The abundance on silicate was comparable to the other substrata.

The index of dispersion showed the same tendencies as those revealed in

the abundance. In scree slopes and in the highest sectors on dolomite where the index was very high, B. levigata formed a distinct mosaic pattern. In grassland, the rosettes had a more mosaic-like distribution than in the intermediate sectors where the lowest indices were found (Table 18, Fig. 35). The differences were significant ( $P < 1\%$ , Table 22). On serpentine the index of dispersion was more or less the same as in the intermediate sectors on dolomite, only the highest plot on serpentine showing a distinct mosaic-like distribution (Fig. 36). The differences of index of dispersion between the niches on serpentine were, in contrast to density and abundance, statistically significant ( $P < 5\%$ , Table 22). Behaviour of Biscutella levigata in the two silicate plots studied was more or less the same as on the other substrata.

**Separate evaluations for each age-state variant.** Evaluations carried out separately for each given age-state variant revealed a rather complex situation. The densities of seedlings were very low and significantly

Table 19. Seedlings: Density, abundance, and index of dispersion ( $\pm$ S.D.). Census of August 1983.

Tab. 19. Keimlinge: Dichte, Abundanz und Dispersionsindex ( $\pm$  s<sub>x</sub>). Zählung vom August 1983.

Site	Dolomite	Serpentine
	Density Individuals / dm <sup>2</sup>	
grassland / dense veg.	0	0.07 $\pm$ 0.049
intermediate	0.013 $\pm$ 0.028	0.17 $\pm$ 0.16
scree / sparse veg.	0.072 $\pm$ 0.076	0.22 $\pm$ 0.24
highest	0	0
all sectors	0.022 $\pm$ 0.49	0.15 $\pm$ 0.17
acidic silicate	0	
	Abundance Individuals / dm <sup>2</sup>	
grassland / dense veg.	0	1.12 $\pm$ 0.24
intermediate	1.05 $\pm$ 0.08	1.32 $\pm$ 0.42
scree / sparse veg.	1.16 $\pm$ 0.19	2.02 $\pm$ 1.51
highest	0	0
all sectors	1.11 $\pm$ 0.15	1.47 $\pm$ 0.91
acidic silicate	0	
	Index of dispersion (4 dm <sup>2</sup> )	
grassland / dense veg.	-	1.25 $\pm$ 0.40
intermediate	1.42 $\pm$ 0.73	2.01 $\pm$ 1.53
scree / sparse veg.	1.14 $\pm$ 0.32	2.80 $\pm$ 1.88
highest	-	-
all sectors	1.26 $\pm$ 0.50	2.02 $\pm$ 1.49
acidic silicate	-	

different within the niches on dolomite ( $P < 5\%$ ) and between dolomite and serpentine ( $P < 1\%$ ). On the other hand, The abundance of seedlings and index of dispersion were higher but no significant differences occurred (Tables 19, 22). Patterns in density and abundance of non-reproducing rosettes were generally similar to those revealed in global evaluations. However, significant differences between dolomite and serpentine were found in the index of dispersion ( $P < 5\%$ , Tables 20, 22). As far as reproducing rosettes only are concerned, the density on serpentine was higher than on dolomite ( $P < 1\%$ ). Also the density differences between various dolomite niches were significant ( $P < 1\%$ ), whereas on serpentine no distinct differences appeared. The abundances and the index of dispersion followed distinct patterns within either of the substrata studied; differences between niches were not significant on dolomite, but significant on serpentine ( $P < 1\%$ , Tables 21, 22).

Table 20. Non-reproducing rosettes: Density, abundance, and index of dispersion ( $\pm$  S.D.). Census of August 1983.

Tab. 20. Nichtreproduzierende Rosetten: Dichte, Abundanz und Dispersionsindex ( $\pm$   $s_x$ ). Zählung vom August 1983.

Site	Dolomite	Serpentine
	Density Individuals / dm <sup>2</sup>	
grassland / dense veg.	0.54 $\pm$ 0.31	1.29 $\pm$ 0.78
intermediate	0.81 $\pm$ 0.85	1.96 $\pm$ 1.16
scree / sparse veg.	1.99 $\pm$ 0.79	1.40 $\pm$ 0.91
highest	1.73 $\pm$ 0.59	0.42
all sectors	1.19 $\pm$ 0.89	1.53 $\pm$ 0.99
acidic silicate	0.30	
	Abundance Individuals / dm <sup>2</sup>	
grassland / dense veg.	3.45 $\pm$ 0.99	2.67 $\pm$ 0.92
intermediate	2.53 $\pm$ 0.84	3.20 $\pm$ 1.11
scree / sparse veg.	4.78 $\pm$ 1.91	3.17 $\pm$ 1.08
highest	5.98 $\pm$ 2.33	4.20
all sectors	3.90 $\pm$ 1.89	3.09 $\pm$ 1.03
acidic silicate	3.22	
	Index of dispersion (1 dm <sup>2</sup> )	
grassland / dense veg.	5.20 $\pm$ 1.68	3.72 $\pm$ 1.99
intermediate	3.03 $\pm$ 1.24	3.25 $\pm$ 1.15
scree / sparse veg.	6.69 $\pm$ 2.78	3.46 $\pm$ 1.15
highest	9.01 $\pm$ 3.63	7.42
all sectors	5.48 $\pm$ 3.02	3.64 $\pm$ 1.60
acidic silicate	5.50	

Distribution of B. levigata plants calculated in 1 dm<sup>2</sup> and 4 dm<sup>2</sup> subplots always corresponded to a statistically significant not random pattern (P < 0.1%). The test of horizontal and vertical distribution revealed mostly a mosaic-like pattern and only in a few 1 m<sup>2</sup> plots a random distribution was observed; however, no influence of direction or slope gradient could be recognized (Table 23).

#### 4.2.2. Temporal distribution

**Genets.** The number of seedlings in dolomite grassland and within the highest sectors was very small and seedlings did not appear every year (Table 24). The number of individuals within intermediate sectors on

Table 21. Reproducing rosettes: Density, abundance, and index of dispersion ( $\pm$  S.D.). Census of August 1983.

Tab. 21. Reproduzierende Rosetten: Dichte, Abundanz und Dispersionsindex ( $\pm$  s<sub>x</sub>). Zählung vom August 1983.

Site	Dolomite	Serpentine
	Density Individuals / dm <sup>2</sup>	
grassland / dense veg.	0.033 $\pm$ 0.026	0.20 $\pm$ 0.22
intermediate	0.068 $\pm$ 0.048	0.43 $\pm$ 0.20
scree / sparse veg.	0.23 $\pm$ 0.17	0.22 $\pm$ 0.16
highest	0.090 $\pm$ 0.059	0.12
all sectors	0.10 $\pm$ 0.12	0.29 $\pm$ 0.21
acidic silicate	0.07	
	Abundance Individuals / dm <sup>2</sup>	
grassland / dense veg.	1.11 $\pm$ 0.13	1.26 $\pm$ 0.33
intermediate	1.41 $\pm$ 0.40	1.85 $\pm$ 0.37
scree / sparse veg.	1.59 $\pm$ 0.33	1.44 $\pm$ 0.30
highest	1.40 $\pm$ 0.23	4.00
all sectors	1.40 $\pm$ 0.34	1.67 $\pm$ 0.35
acidic silicate	1.75	
	Index of dispersion (4 dm <sup>2</sup> )	
grassland / dense veg.	1.10 $\pm$ 0.12	1.20 $\pm$ 0.26
intermediate	2.01 $\pm$ 1.09	3.10 $\pm$ 1.10
scree / sparse veg.	2.83 $\pm$ 1.00	2.42 $\pm$ 0.91
highest	1.85 $\pm$ 1.01	8.53
all sectors	2.04 $\pm$ 1.07	2.62 $\pm$ 1.76
acidic silicate	2.01	

dolomite decreased regularly from census to census but the the population became stabilized in the third year. Many seeds germinated only in August or September (Table 24, Fig. 38). As far as the dolomite scree is concerned, losses of seedlings and young plants were rather irregular; a particularly great reduction was observed after the first winter and in July of the second year after seedling emergence. The survival of genets followed type II of DEEVEY (1947). The germination in August and September was lower. A very large number of seedlings was found in 1984 (Table 24, Fig. 38).

A great reduction in number of genets during their first winter as well as in the second summer and winter was characteristic for the serpentine sectors with high vegetation density. On the other hand, no more young plants died in their third summer. Only a few new seedlings were found during August and September census (Table 25, Fig. 38). In the intermediate sectors and sectors with thin vegetation on serpentine, a great amount of seedlings germinated in 1983 and 1984, but pronounced losses

Table 22. Differences in density, abundance, and index of dispersion within and between dolomite and serpentine subpopulations. Niveau of significance is indicated. Census of August 1983.

Tab. 22. Unterschiede in Dichte, Abundanz und Dispersionsindex innerhalb und zwischen Subpopulationen auf Dolomit und Serpentin; das Signifikanzniveau ist angegeben. Zählung vom August 1983.

aov = analysis of variance

S = seedlings, N = non-reproducing, R = reproducing rosettes

	All age-states	S only	N only	R only
Density				
DOL aov	1%	5%	1%	1%
SER aov	-	-	-	-
all sites aov	1%	5%	5%	1%
DOL-SER t-test	-	1%	-	1%
Abundance				
DOL aov	1%	-	1%	-
SER aov	-	-	-	1%
all sites aov	1%	-	1%	1%
DOL-SER t-test	-	-	-	-
Index of dispersion	(1dm <sup>2</sup> )	(4dm <sup>2</sup> )	(1dm <sup>2</sup> )	(4dm <sup>2</sup> )
DOL aov	1%	-	1%	-
SER aov	5%	-	-	1%
all sites aov	1%	-	1%	1%
DOL-SER t-test	-	-	5%	-

occurred during the first years of their life (Table 25, Fig. 38). Contrary to the situation in sectors with dense vegetation, only about 14% were counted after three years. On serpentine the genets had also a Deevey's type II survivorship curve. No seedlings at all were found in the highest sectors on serpentine and on acidic silicate.

**Ramets.** The net number of non-reproducing rosettes during one vegetation season always remained more or less stable, with only a slight maximum in August, gains being apparently equivalent to losses. On account of

Table 23. Probability of mosaic-like vs. random distribution of ramets; niveau of significance is indicated. Census of August 1983.

Tab. 23. Wahrscheinlichkeit für gehäufte Verteilung gegen Zufallsverteilung von Ramets; das Signifikanzniveau ist angegeben. Zählung vom August 1983.

H = horizontal column sub-plot, V = vertical column sub-plot  
DOL = dolomite, SER = serpentine, SIL = acidic silicate

1m <sup>2</sup> plot	1dm <sup>2</sup>	4dm <sup>2</sup>	H	V	1dm <sup>2</sup> plot	1dm <sup>2</sup>	4dm <sup>2</sup>	H	V
DOL 1A	.1%	.1%	.1%	.1%	SER 1A	.1%	.1%	.1%	.1%
1B	.1%	.1%	.1%	.1%	1B	.1%	.1%	-	1%
DOL 2A	.1%	.1%	.1%	.1%	SER 2A	.1%	.1%	1%	1%
2B	.1%	.1%	.1%	.1%	2B	.1%	.1%	.1%	.1%
DOL 3A	.1%	.1%	.1%	.1%	SER 3A	.1%	.1%	-	5%
3B	.1%	.1%	.1%	.1%	3B	.1%	.1%	.1%	.1%
DOL 4A	.1%	.1%	1%	.1%	SER 4A	.1%	.1%	5%	5%
4B	.1%	.1%	.1%	.1%	4B	.1%	.1%	.1%	.1%
DOL 5A	.1%	.1%	-	1%	SER 5A	.1%	.1%	.1%	.1%
5B	.1%	.1%	-	.1%	5B	.1%	.1%	.1%	.1%
DOL 6A	.1%	.1%	.1%	.1%	SER 6A	.1%	.1%	1%	.1%
6B	.1%	.1%	.1%	5%	6B	.1%	.1%	.1%	.1%
DOL 7A	.1%	.1%	.1%	.1%	SER 7A	.1%	.1%	.1%	.1%
7B	.1%	.1%	5%	1%	7B	.1%	.1%	.1%	-
DOL 8A	.1%	.1%	.1%	.1%	SER 8A	.1%	.1%	1%	.1%
8B	.1%	.1%	.1%	.1%	8B	.1%	.1%	.1%	5%
DOL 9A	.1%	.1%	.1%	.1%	SER 9A	.1%	.1%	.1%	.1%
9B	.1%	.1%	.1%	.1%	9B	.1%	.1%	.1%	.1%
DOL 10A	.1%	.1%	.1%	.1%	SER 10A	.1%	.1%	-	.1%
DOL 10B	.1%	.1%	.1%	.1%	10B	.1%	.1%	.1%	.1%
DOL 11A	.1%	.1%	.1%	.1%	SER 11A	.1%	.1%	.1%	.1%
11B	.1%	.1%	.1%	.1%					
DOL 12A	.1%	.1%	.1%	.1%	SIL A	.1%	.1%	.1%	1%
12B	.1%	.1%	.1%	.1%	B	.1%	.1%	.1%	.1%



the high standard deviation, there were no differences in the behaviour of dolomite and serpentine plants (Tables 26, 27). The number of reproducing rosettes decreased mostly from July through August to September; a high standard deviation was also found, but the total number was more than twice as high on serpentine than on dolomite (Tables 26, 27, Figs 39, 40).

On dolomite scree and in intermediate serpentine sectors the highest number of non-reproducing rosettes was found in September. In the intermediate and highest sectors as well as in sectors with low vegetation density on serpentine and on acidic silicate the maximum of reproducing rosettes was in August (Table 27).

The behaviour of the age-state variants over several years is exempli-

Table 24. Net number, gains, and losses of genets (seedlings and young plants) on dolomite.

Tab. 24. Netto Anzahl, Gewinne und Verluste von Genets (Keimlinge und Jungpflanzen) auf Dolomit.

J = July, A = August, S = September

82 = germinated in 1982, 83 = in 1983, 84 = in 1984

Grassland				Intermediate													
6m <sup>2</sup>	1982			1983			1984		8m <sup>2</sup>	1982			1983			1984	
	J	A	S	J	A	S	A	S		J	A	S	J	A	S	A	S
82 net	0	2	2	1	1	1	1	1	82 net	12	12	12	10	10	9	8	8
gains	2								gains	12	2	1					
losses				1					losses	2		1	2		1		
83 net				0 0 0			0 0		83 net				9 10 10			7 6	
gains									gains				9 1 1				
losses									losses				1			3 1	
84 net							1 1		84 net							31 31	
gains							1		gains							31 3	
losses									losses							3	

Scree				Highest													
6m <sup>2</sup>	1982			1983			1984		4m <sup>2</sup>	1982			1983			1984	
	J	A	S	J	A	S	A	S		J	A	S	J	A	S	A	S
82 net	29	30	29	23	21	19	12	-	82 net	0	0	0	0	0	0	0	-
gains	29 2								gains								
losses	1 1			6 2 2			7		losses								
83 net				31 38 34			21 -		83 net				0 0 0			0 -	
gains				31 7					gains								
losses				4			13		losses								
84 net							103 -		84 net							3 -	
gains							103		gains							3	
losses									losses								

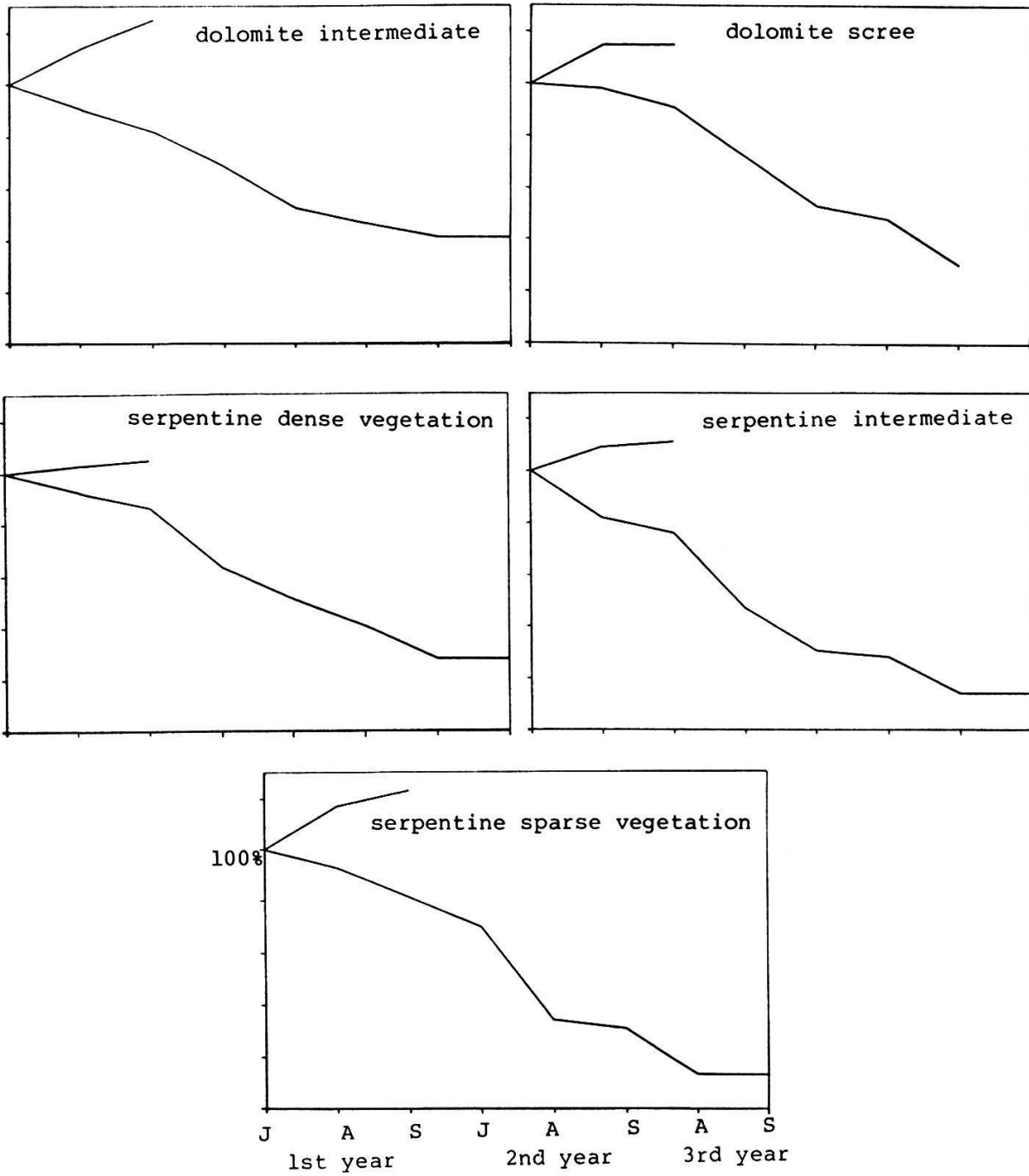

Fig. 38. Gains and survivorship curves of genets (seedlings and young plants); number of seedlings germinated in July were taken to be 100%.

Abb. 38. Gewinne und Ueberlebenskurven von Genets (Keimlinge und Jungpflanzen), die Anzahl im July gekeimter Keimlinge wurde als 100% genommen.



terized the behaviour of Biscutella levigata in all niches. Unfortunately, the observations in serpentine sectors could not be completed. In the dolomite grassland, only a small number of flower buds and flowers was found in July; in August, some unripe fruits occurred but in September only very few ripe yet empty fruits were left (Table 28). Many more reproductive units were observed in the scree slopes and in the highest sectors on dolomite; however, a great reduction also occurred, especially in the highest sectors. The seed production was very good on scree slopes but limited in the highest sectors. As far as the occur-

Table 26. Net number, added gains, and subtracted losses of ramets (N = non-reproducing and R = reproducing rosettes) per m<sup>2</sup> (± S.D.) during summer 1983 on dolomite.

Tab. 26. Netto-Anzahl mit addierten Gewinnen und subtrahierten Verlusten von Ramets (N = nichtreproduzierenden und R = reproduzierenden Rosetten) pro m<sup>2</sup> (± s<sub>x</sub>) während des Sommers 1983 auf Dolomit.

Site	Month	Net number	Added gains	Subtracted losses
grassland	N	July	51.8 ± 28.5	
		Aug.	54.0 ± 31.3	56.5 ± 35.1
		Sept.	49.5 ± 33.3	57.8 ± 36.1
	R	July	2.33 ± 2.88	
		Aug.	2.17 ± 2.64	2.33 ± 2.88
		Sept.	1.17 ± 1.47	2.33 ± 2.88
intermediate	N	July	75.5 ± 81.1	
		Aug.	80.3 ± 85.5	84.4 ± 87.4
		Sept.	72.6 ± 77.4	87.6 ± 88.4
	R	July	7.13 ± 4.94	
		Aug.	6.75 ± 4.77	7.25 ± 5.06
		Sept.	6.25 ± 4.40	7.38 ± 5.00
scree slope	N	July	192.0 ± 92.5	
		Aug.	196.0 ± 83.3	209.8 ± 92.1
		Sept.	185.2 ± 86.8	216.8 ± 94.0
	R	July	24.8 ± 16.7	
		Aug.	23.3 ± 17.6	25.7 ± 17.1
		Sept.	22.8 ± 18.0	26.0 ± 17.5
highest site	N	July	162.5 ± 47.3	
		Aug.	173.5 ± 59.1	180.3 ± 52.3
		Sept.	165.0 ± 53.0	187.8 ± 50.6
	R	July	12.0 ± 7.79	
		Aug.	9.00 ± 5.89	12.25 ± 7.79
		Sept.	7.00 ± 5.48	12.25 ± 7.79

rence of the reproductive units is concerned, intermediate sectors represented a transition between dolomite grassland and scree (Table 28, Fig. 43).

The behaviour of the plants in the serpentine plots was quite comparable

Table 27. Net number, added gains, and subtracted losses of ramets (N = non-reproducing and R = reproducing rosettes) per m<sup>2</sup> ( $\pm$  S.D.) during summer 1983 on serpentine and acidic silicate.

Tab. 27. Netto-Anzahl mit addierten Gewinnen und subtrahierten Verlusten von Ramets (N = nichtreproduzierende und R = reproduzierende Rosetten) pro m<sup>2</sup> ( $\pm$  s) während des Sommers 1983 auf Serpentin und saurem Silikat.<sup>x</sup>

Site	Month	Net number	Added gains	Subtracted losses
dense vegetation	N	July	112.0 $\pm$ 73.4	
		Aug.	123.7 $\pm$ 80.9	129.0 $\pm$ 83.3
		Sept.	122.7 $\pm$ 82.4	139.2 $\pm$ 88.7
	R	July	21.0 $\pm$ 22.5	
		Aug.	20.3 $\pm$ 21.9	22.5 $\pm$ 23.8
		Sept.	17.3 $\pm$ 20.7	22.5 $\pm$ 23.8
intermediate	N	July	168.6 $\pm$ 106.7	
		Aug.	195.5 $\pm$ 115.3	203.0 $\pm$ 117.8
		Sept.	198.8 $\pm$ 114.3	217.0 $\pm$ 120.3
	R	July	42.9 $\pm$ 17.0	
		Aug.	43.6 $\pm$ 20.4	47.8 $\pm$ 20.3
		Sept.	41.5 $\pm$ 20.7	48.4 $\pm$ 20.5
sparse vegetation	N	July	129.7 $\pm$ 81.6	
		Aug.	138.2 $\pm$ 88.3	145.0 $\pm$ 91.3
		Sept.	134.7 $\pm$ 82.5	153.7 $\pm$ 96.6
	R	July	21.5 $\pm$ 15.5	
		Aug.	22.2 $\pm$ 16.6	23.8 $\pm$ 17.7
		Sept.	20.8 $\pm$ 15.1	24.5 $\pm$ 18.4
highest site	N	July	66.5	
		Aug.	80	83
		Sept.	78.5	86
	R	July	17.5	
		Aug.	12	17.5
		Sept.	17.5	23
Acidic silicate	N	July	29	
		Aug.	30	31
		Sept.	27.5	32
	R	July	6.5	
		Aug.	7	7.5
		Sept.	6	7.5

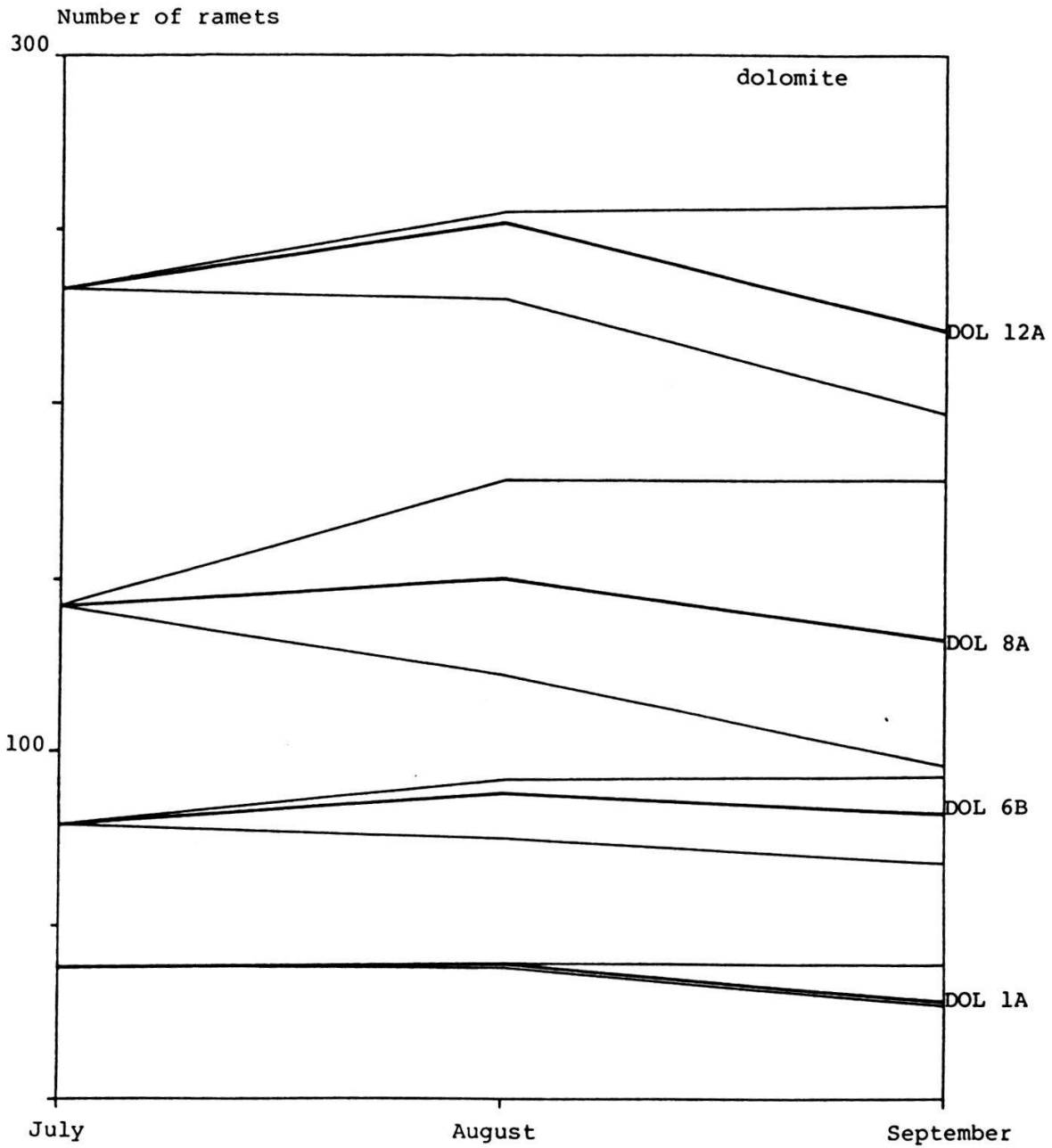

Fig. 39. Net number, added gains and subtracted losses of ramets per  $m^2$  during summer 1983 within selected plots on dolomite.

Abb. 39. Netto-Anzahl mit addierten Gewinnen und subtrahierten Verlusten von Ramets pro  $m^2$  während des Sommers 1983 in ausgewählten Flächen auf Dolomit.

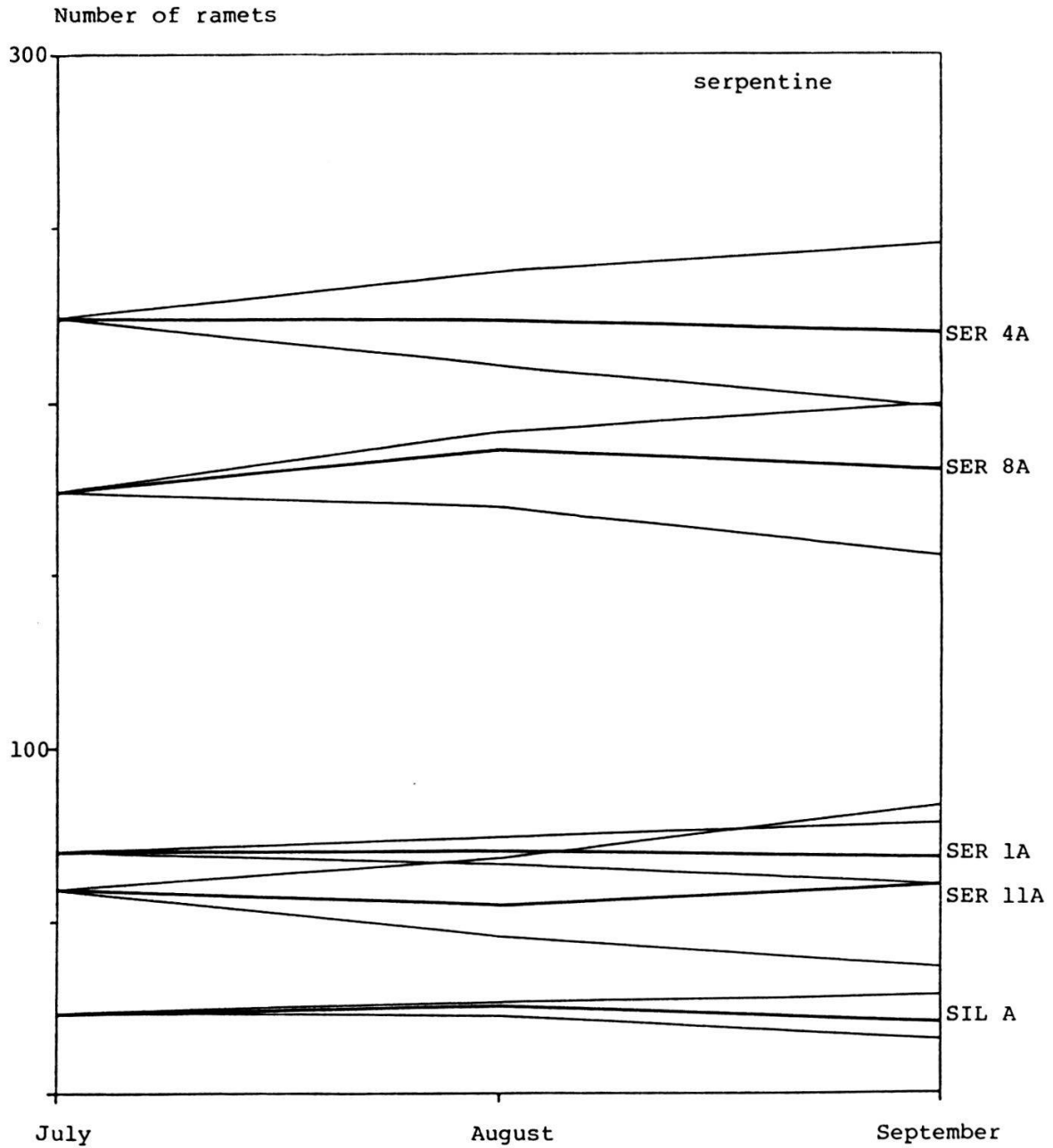
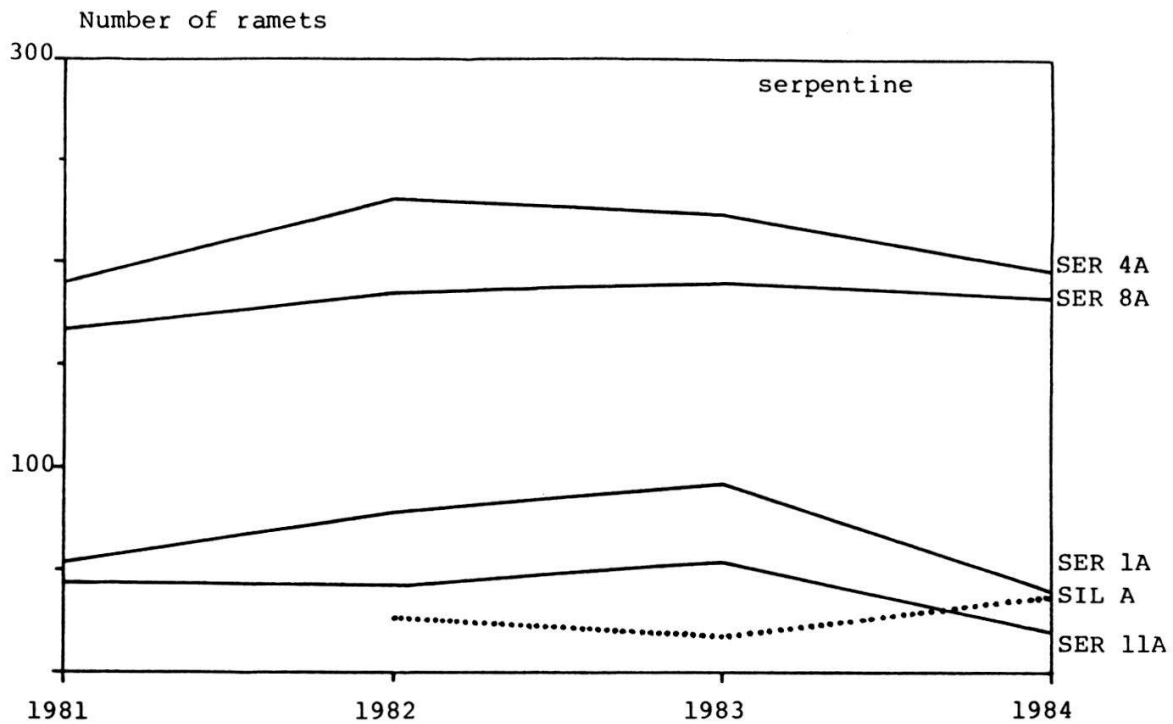
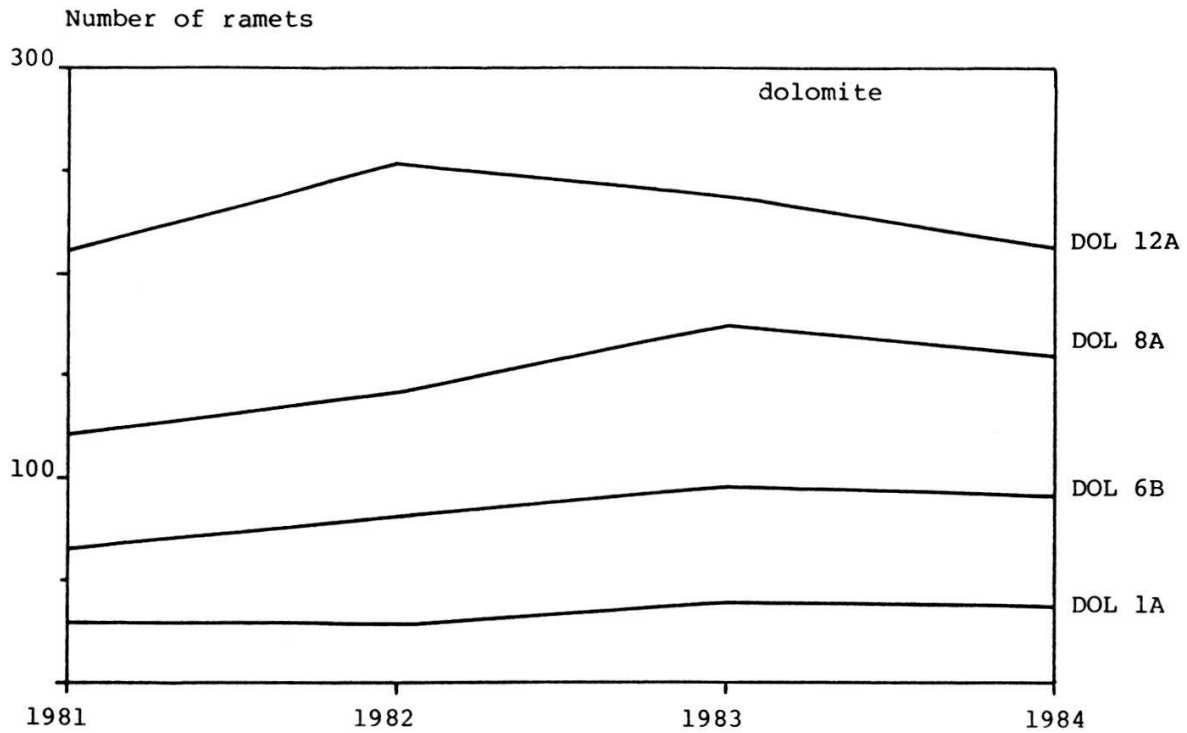

Fig. 40. Net number, added gains and subtracted losses of ramets per m<sup>2</sup> during summer 1983 within selected plots on serpentine and acidic silicate.

Abb. 40. Netto-Anzahl mit addierten Gewinnen und subtrahierten Verlusten von Ramets pro m<sup>2</sup> während des Sommers 1983 in ausgewählten Flächen auf Serpentin und saurem Silikat.



Figs 41,42. Net numbers of ramets per m<sup>2</sup> during 4 years within selected plots on dolomite, serpentine, and acidic silicate (SIL).  
 Abb. 41,42. Netto-Anzahl Ramets pro m<sup>2</sup> während 4 Jahren in ausgewählten Flächen auf Dolomit, Serpentin und saurem Silikat.

DOL 1A: grassland  
 DOL 6B: intermediate sites  
 DOL 8A: scree  
 DOL 12A: highest sites

SER 1A: dense vegetation  
 SER 4A: intermediate sites  
 SER 8A: sparse vegetation  
 SER 11A: highest sites



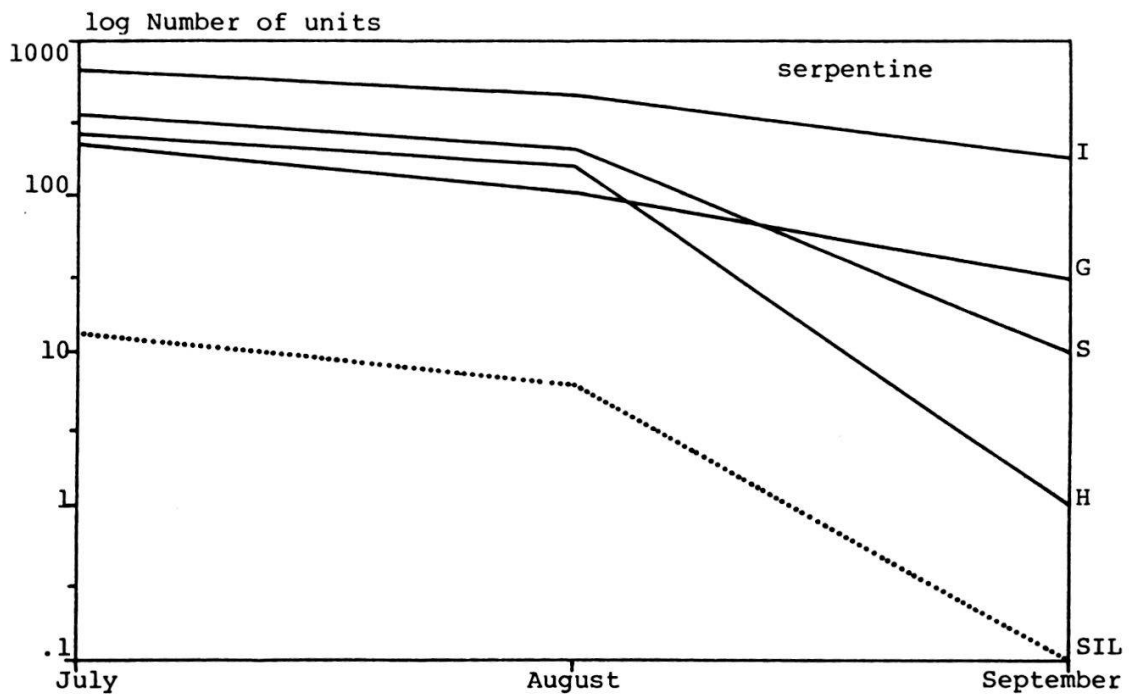
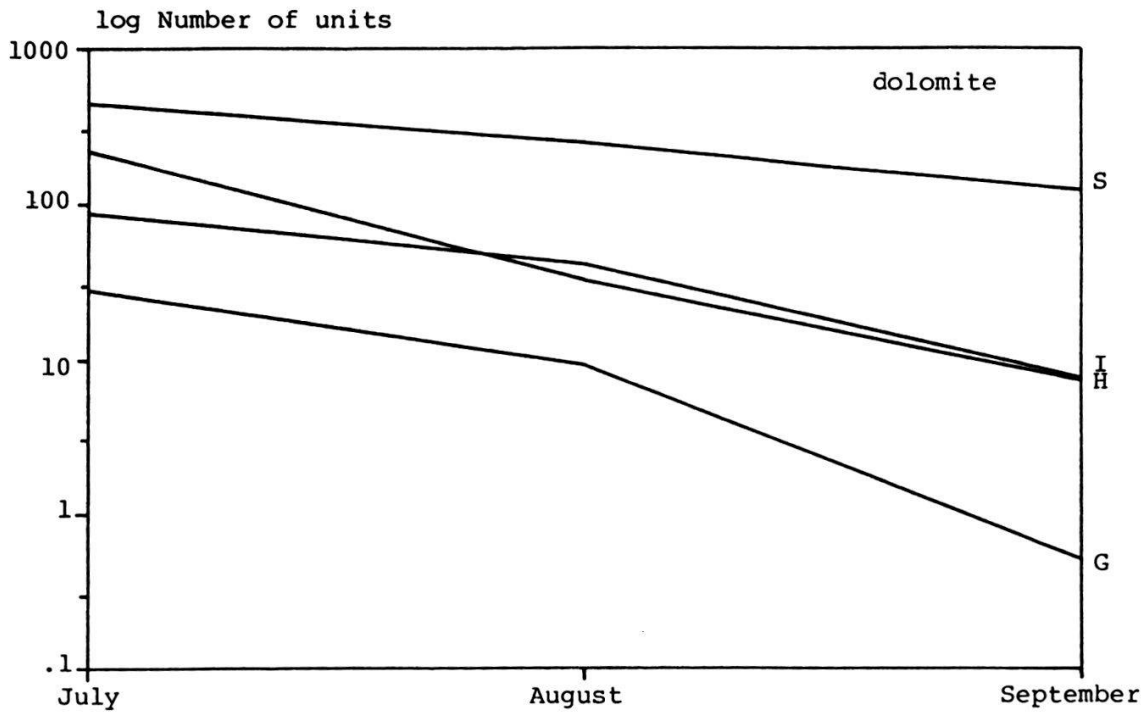

Figs 43,44. Number of reproductive units per m<sup>2</sup> at different sites on dolomite, serpentine, and acidic silicate in summer 1983.

Abb. 43,44. Anzahl Fortpflanzungseinheiten pro m<sup>2</sup> auf verschiedenen Standorten auf Dolomit, Serpentin und saurem Silikat im Sommer 1983.

G = grassland, dense vegetation  
I = intermediate sites

H = highest sites  
S = scree, sparse vegetation

in all sectors except the highest ones, the same tendencies as on dolomite scree slopes being observed. In July, very numerous flower buds and

Table 28. Number of reproductive units per m<sup>2</sup> in summer 1983.  
Tab. 28. Anzahl Fortpflanzungseinheiten pro m<sup>2</sup> im Sommer 1983.

- \*) Seeds were already dispersed - Samen waren schon verstreut  
 \*\*) Many reproducing rosettes were eliminated by grazing - viele reproduzierende Rosetten sind abgefressen  
 A = flower buds - Blumenknospen, B = flowers - Blüten, C = unripe fruits - unreife Früchte, D = ripe fruits - reife Früchte, - E = seeds (not included in the total amount) - Samen (nicht im Gesamttotal enthalten).

Site	Month	A	B	C	D	E	Total
<u>Dolomite:</u> grassland	July	8.3	19	.5	0	0	27.8
	August	0	0	9	0	0	9
	Sept.	0	0	0	.5	0	.5
intermediate	July	6.8	50.4	30.2	0	0	87.4
	August	0	0	40.1	0	0	40.1
	Sept.	0	0	0	7.4	2.5	7.4
scree slopes	July	193.3	222.5	33.2	0	0	448
	August	0	2	239.5	5.3	4.2	245.8
	Sept.	0	0	0	119	86	119
highest sites	July	191.5	26.5	0	0	0	218
	August**	0	31.5	0	0	0	31.5
	Sept.	0	0	.75	6.5	2.5	7.25
<u>Serpentine:</u> dense vegetation	July	161	40.1	15.3	0	0	216.5
	August	0	3	100.8	0	0	103.8
	Sept.	0	0	1.4	28	20.3	29.4
intermediate	July	470	132.9	47.4	0	0	650.3
	August	1.5	21	421.5	0	0	444
	Sept.	0	0	.8	178.4	71.3	179.2
sparse vegetation	July	38.8	267.3	29.3	0	0	335.4
	August	0	0	199.2	0	0	199.2
	Sept.*	0	0	0	9.8	2.7	9.8
highest sites	July	230	23	0	0	0	253
	August	0	2	152	0	0	154
	Sept.**	0	0	0	1	0	1
<u>Acidic silicate</u>	July	.5	11	1.5	0	0	13
	August	0	0	6	0	0	6
	Sept.	0	0	0	0	0	0

flowers were observed in sectors with dense vegetation and intermediate ones; in August, unripe fruits prevailed whereas in September mostly ripe fruits with a good seed content were found. Abundant flowers and unripe fruits were counted also in the plots with thin vegetation, but during the September census, most of the ripe fruits with the seeds were already dispersed (Table 28, Fig. 44).

Only few reproductive units were found in July and August on acidic silicate and no seed output was observed in September (Table 28, Fig. 44).

## 5. DISCUSSION

The present studies reveal that Biscutella levigata is predominantly allogamous and highly self-incompatible. However, its theoretically possible wide gene exchange is apparently limited, at least in some alpine subpopulations. Biology of reproduction undoubtedly plays an important role in this process; factors limiting the gene flow apparently operate both at the pollination phase as well as during seed development and their subsequent dispersal.

It seems that the limited gene flow in B. levigata is influenced by spatial and/or temporal variation in floral supply as well as by the foraging behaviour of pollinators. Populations of Biscutella levigata are variable as to their density. In the study area, population density was very low in dolomite grassland, whereas dense clusters of rosettes were found on dolomite scree. On serpentine, a rather consistent pattern in density was observed.

On the whole, about 10% of the rosettes produced inflorescences. The general pattern of production of floral structures in B. levigata is similar to e.g. Hieracium floribundum (THOMAS and DALE 1975). However, some differences between the substrata studied were noted. On dolomite, reproducing rosettes of B. levigata most frequently represented less than 10%, but the corresponding proportion on serpentine was always higher than 10%. On the other hand, no pronounced differences between

various sites within a given substratum were observed. The average number of flowers per inflorescence was about 15, on dolomite scree usually being higher than on dolomite grassland, whereas on serpentine no distinct differences between the niches occurred. It seems therefore that the density of floral structures in B. levigata results primarily from the distribution pattern of whole flowering shoots.

Spatial separation of male and female functions should considerably reduce the deposition of self-pollen and increase the amount of outgoing pollen (see e.g. WEBB and BAWA 1983, BAWA and OPLER 1975, BAWA and BEACH 1981, LLOYD and YATES 1982). However, as emphasized by BAWA et al. (1983), temporal separation of male and female functions is more important than spatial separation in achieving a high level of outcrossing. In B. levigata flowers develop successively, the flowering period usually lasting from the middle of July to the middle of August. Flowers within a given inflorescence also open in a certain sequence from bottom to top.

The number of flower buds and flowers decreased greatly throughout the flowering season, numerous reproductive units being aborted. Limiting of flower resources by grazing was also an important factor in Biscutella levigata, especially on dolomite grassland and in highest sites on dolomite. A reduced floral supply represents a factor influencing the seed output; in predominantly allogamous taxa it obviously contributes to a reduced gene pool. Our observations corroborate the previous data: e.g. KRÜSI (1981) found that cutting in June almost completely prevented sexual reproduction in Brachypodium pinnatum because all flowering inflorescences were removed. Also in Cardamine insueta growing in hay meadows, all the flower stalks were usually removed by cutting. The seed production in the triploid hybrid, already limited on account of unbalanced genetic structure, was therefore completely prevented (URBANSKA 1980).

Gene flow in and between populations is influenced by the number of individuals mating at random, defined as breeding unit or neighbourhood size (KERSTER 1964, WRIGHT 1943, 1946). It was assumed that neighbourhood size in bee-pollinated species does not change in colonies with different densities (LEVIN and KERSTER 1969). However, in Phlox that is principally pollinated by Lepidoptera, the neighbourhood size was reported to range from 75 to 282 individuals in colonies of different densities (LEVIN and KERSTER 1968). Also RICHARDS and IBRAHIM (1978) empha-

sized a density-dependent neighbourhood size in Primula veris. The much lower frequency of insect visits in areas of low plant density are likely to make neighbourhood size highly density-dependent and will not be compensated for by greater insect travel.

The neighbourhood size in B. levigata was not studied in detail and our observations have only an indicative value. In the alpine vegetation belt bees usually do not occur. During the four vegetation seasons of the present study, only few Syrphidae and Lepidoptera were observed as visitors to Biscutella flowers. According to KAY (1978) Syrphidae show a strong preference for yellow flowers. Their habit of remaining stationary in the air and suddenly flying distances over several meters at a very high speed makes their foraging pattern rather unpredictable. Lepidoptera move typically from a given plant to one of its near-neighbours; although long-distance flights are a part of their normal behaviour pattern, these proved to be rare events i.e. not exceeding 2% (LEVIN and KERSTER 1968). Precise behaviour of insects visiting Biscutella levigata remain to be investigated, but it is not excluded that differences in population density observable in various sectors may influence the foraging pattern of pollinators. HANDEL (1983) argued recently that the pollination biology of any species is not constant among populations, but may change with the nature and behaviour of the available pollinators. This aspect should also be taken into account in future investigations on B. levigata.

The sexual reproduction in B. levigata is greatly influenced not only by flower resources and pollinators but also by grazing intensity. Also at later post-mating stages grazers may eliminate some reproductive units. The amount of fruits per m<sup>2</sup> was very low in dolomite grassland and low in dolomite intermediate sectors. The seed output may therefore vary dramatically from site to site, especially on dolomite: for instance, in a highest sector on dolomite no fruits at all were produced for four years because all flowers or unripe fruits were grazed by Capra ibex.

Seed dispersal in Biscutella levigata most frequently involve the whole fruits (MÜLLER-SCHNEIDER 1977). Our field observations suggest that the dispersal pattern in B. levigata is rather complex. Strong gusts of wind can occasionally tear off ripe fruits and transport them over longer distances. The water running from melting snow can also transport fruits

lying on the soil downhill to lower sites. Most frequently, however, the fruits fall to the ground and remain in the immediate vicinity of the mother plant. In case of early snowfall in autumn the inflorescences are pressed down with all the fruits on them. After the snow has melted, the whole group of seeds germinates forming a dense cluster (GASSER 1983). A similar pattern of local dispersal was observed in alpine populations of Ranunculus montanus s.l. by DICKENMANN (1982). MARCHAND and ROACH (1980) considered wind as the important agent of seed dispersal in Arenaria groenlandica and Diapensia lapponica in the alpine tundra; however, they noted that the seeds were usually not transported further than 0.5 m to 1 m. Arenaria groenlandica and Diapensia lapponica have no particular adaptations for seed dispersal by wind. Senecio jacobaea on the other hand, produce achenes with typical pappus morphology. They are adapted to dispersal by wind, but nevertheless 60% of all achenes produced remain close to the mother plants, only about 0.4% being distributed further than 4.6 m (POOLE and CAIRNS 1940).

The seed dispersal in Biscutella levigata often results in the formation of seedling cohorts representing siblings or half-siblings; the gene pool of a given population sector may thus be locally limited.

The germination capacity of Biscutella levigata on moist blotting paper in the climatic chamber consistently approached 100%. Contrary to this pattern, germination percentages in the field were variable and apparently influenced by alpine substrata; the greenhouse experiments also indicated influence of substratum on germinating behaviour. The present results corroborate the previous data of e.g. FOSSATI (1980) who found great influence of substratum on germination in alpine plants. Also SCHÜTZ and URBANSKA (1984) observed differential seed germination in agamospermous Taraxacum alpinum from carbonate and acidic silicate. The behaviour of B. levigata shows that germinating behaviour of alpine plants may reflect adaptation to various substrata. In this respect, our results do not support the opinion of some previous authors (e.g. ELLENBERG 1958, GIGON 1971) who argued that substratum influences later developmental phases, but not the germinating behaviour in plants.

Freshly germinated seeds of B. levigata were found in the wild during the whole vegetation period, but germination occurred mostly soon after the snow had melted. Our field experiments demonstrate that seeds of B. levigata remain viable for at least several years in alpine soils. Seed dormancy seems to be enforced and the persistent population of buried

seeds in alpine soils is apparently composed of various generations. In this respect, Biscutella levigata is similar to many other alpine species (see e.g. FOSSATI 1980, WEILENMANN 1981, ZUUR-ISLER 1982, SCHÜTZ 1983, and SCHÜTZ unpubl).

The pre-establishment mortality of Biscutella levigata was very high in the extreme environment of scree and most seedlings died after germination, the survivorship curve being of DEEVEY type III. Contrary to this pattern, the survival of seedlings in dense vegetation was surprisingly high; their survivorship curve was that of DEEVEY type II, the mortality risk being always more or less constant. The present results are in agreement with data of ZUUR-ISLER (1982) of alpine serpentine plants as well as with those of FOSSATI (1980) concerning taxa from carbonate and acidic silicate. On the other hand, MARCHAND (1984) found the greatest single cause of mortality in frost-heaving at the end of the growing season. Seedling mortality is often the result of soil drought and needle ice formation (BLISS 1985). It seems that soil water stress might have had an adverse effect on seedling development of Biscutella levigata especially on dolomite scree; however, drought often occurs for longer periods at high altitudes and cannot be considered as an isolated event in the life of alpine plants.

The present results suggest that the recruitment of new genets follows different pathways in various ecological niches of B. levigata and obviously influences the gene pool of given sectors.

Not only life history elements but also clonal growth limits the gene flow in Biscutella levigata. The young genets form additional rosettes rather rapidly; our field observations corroborate previous experimental data of MANTON (1934) and WEILENMANN (1981). Even under harsh alpine conditions the first additional rosettes were observed already in one-year-old genets. First additional rosettes appear close to the mother rosette, but in older plants, rosettes from new root suckers were developed also at some distance, up to approximately 1 m.

The ramets of B. levigata often grow very mosaic-like and no influence of the slope gradient on spatial pattern were observed. The behaviour of B. levigata is similar to that observed in Viola blanda, V. pallens, and V. incognita (SCHELLNER et al. 1982) as well as Cardamine rivularis, C. insueta, and C. schulzii (ZIMMERLI 1983). Unfortunately, it could not be decided with field methods whether all adjacent rosettes belong to the

same clone or represent different genets as Biscutella levigata has no morphological characters that could be used as markers. In this respect, B. levigata differs from Trifolium repens where CAHN and HARPER (1976) identified clones by leaf markers and found that various genets were intimately mixed. Genets of Festuca rubra could also have been identified by some morphological characters; in this taxon, however, genets grow mostly in neighbourhood (HARBERD 1961).

Limited size of breeding units is a prerequisite for the formation of local races which is a first step in primary speciation (GRANT 1963, 1981, 1985). The present results bring mostly circumstantial evidence of gene flow limitations in Biscutella levigata. However, the alpine populations studied in the course of the present investigations exhibit clear adaptations to their substrata, not in morphological but in physiological characteristics, and therefore should be considered as edaphic races.

A further ecological differentiation in Biscutella levigata occurs on dolomite. It is influenced by particular niches and mostly reflected in demographic structure of population sectors. Depending on a given sector, competition and/or soil development lead to differences in size, density, and/or distribution of age-state variants; the present study corroborates our previous data (GASSER 1983). In the highest sites on dolomite and serpentine, seedlings were scarce and the limited gene pool in these sectors apparently remains rather stabilized. Growth pattern as well as absence of seedling cohorts in dolomite grassland strongly suggest that the population turnover is rather low and the gene pool very limited indeed; on the other hand, the subpopulations occurring on dolomite scree may have both a larger gene pool and higher turnover rates. Intermediate sectors on dolomite are also intermediary in their demographic parameters, between the extreme sites of grassland and scree; the differentiation pattern observed should therefore be considered as (eco)clinal rather than racial.

For the time being, it remains an open question what the input of particular genotypes into the gene pool of a given population sector of B. levigata might be. Both quantitative data on clonal growth and vegetative propagation as well as electrophoretic study of isoenzymes are indispensable for a precise assessment. The intricate pattern of sexual reproduction and vegetative propagation in B. levigata suggests that its



behaviour may be comparable to e.g. Ranunculus repens (SARUKHAN and HARPER 1973) or Trifolium repens (BURDON 1983). Further studies in this respect should prove worthwhile.

#### SUMMARY

Biscutella levigata from the alpine vegetation belt of Davos is predominantly allogamous and highly self-incompatible. However, neighbourhood size is apparently restricted by factors operating in the pollination phase, in seed development, and in seed dispersal. Clear adaptations to dolomite and serpentine were observed; germinating behaviour as well as mortality and development of young plants proved to be greatly dependent on substratum and origin in laboratory, greenhouse, and field trials.

B. levigata forms edaphic races on various alpine substrata. In addition, an (eco)clinal differentiation on dolomite was observed. The subpopulations occurring in dense dolomite grassland were small, had a very low density of ramets and seedlings were scarce. On the other hand, subpopulations inhabiting dolomite scree had a high density of ramets, and seedlings occurred frequently. The subpopulations of intermediate dolomite sites were intermediary. Contrary to the pattern found on dolomite, the demographic behaviour of B. levigata on serpentine was similar in all sites studied.

In conclusion, influence of neighbourhood size on microdifferentiation in plants is briefly discussed.

#### ZUSAMMENFASSUNG

Biscutella levigata aus der alpinen Stufe von Davos ist vorwiegend allogam und selbstinkompatibel. Der Genaustausch ist aber offensichtlich eingeschränkt durch Faktoren, die die Bestäubung, Samenentwicklung und Samenverbreitung beeinflussen. Dolomit- und Serpentinpflanzen weisen eine deutliche Adaptation an das jeweilige Substrat auf: Sowohl die Samenkeimung wie auch die Sterblichkeit und Entwicklung der Jungpflanzen war in der Klimakammer, im Gewächshaus und in Feldversuchen sehr stark vom Substrat und von der Herkunft beeinflusst.

Biscutella levigata bildet edaphische Rassen auf verschiedenen alpinen Substraten. Daneben wurde noch eine klinale Differenzierung auf Dolomit gefunden. Die Subpopulationen, die in dichtem Dolomitrasen vorkommen, sind klein, die klonalen Einheiten haben eine geringe Dichte, und Keimlinge sind selten. Andererseits sind die Subpopulationen auf Dolomitschutt weiter verbreitet, haben eine hohe Dichte von klonalen Einheiten, und Keimlinge sind häufig. Die Subpopulationen auf intermediären Dolomitflächen stehen dazwischen. Im Gegensatz zum Verbreitungsmuster auf Dolomit ist das demographische Verhalten von B. levigata in allen Serpentinflächen ähnlich, und gleicht demjenigen auf Dolomitschutt.

Zusammenfassend wird noch kurz der Einfluss der Stärke des Genflusses auf die Mikrodifferenzierung diskutiert.

**REFERENCES**

- ANTONOVICS J., 1971: The effects of a heterogeneous environment on the genetics of natural populations. *Amer.Sci.* **59**, 593-599.
- ANTONOVICS J., 1976: The input from population genetics: "The new ecological genetics". *System.Botany* **1**, 233-245.
- BAWA K.S. and BEACH J.H., 1981: Evolution of sexual systems in flowering plants. *Ann.Miss.Bot.Gard.* **28**, 254-274.
- BAWA K.S. and OPLER P.A., 1975: Dioecism in tropical forest trees. *Evolution* **29**, 167-169.
- BAWA K.S., WEBB, C.J. and TUTTLE A.F., 1983: The adaptive significance of monoecism in *Cnidioscolus urens* (Euphorbiaceae). *Bot.J.Linn.Soc.* **85**, 213-223.
- BLISS B.L., 1985: Alpine. In: CHABOT B.F. and MOONEY H.A. (eds), *Physiological ecology of North American plant communities*. Chapman and Hall, New York. 41-65.
- BRAUN-BLANQUET J., 1964: *Pflanzensoziologie*. (3rd ed.). Springer, Wien. 865 pp.
- BURDON J.J., 1983: Biological Flora of the British Isles, *Trifolium repens* L. *J.Ecol.* **71**, 307-330.
- CADISCH J. and LEUPOLD W., 1929: Geologische Karte von Mittelbünden 1:25000, Blatt B: Davos. *Beitr.Geol.Karte Schweiz N.F.* **49**.
- CAHN M.G. and HARPER J.L., 1976: The biology of the leaf mark polymorphism in *Trifolium repens* L. 1. Distribution of phenotypes at a local scale. *Heredity* **37**, 309-325.
- DEEVEY E.S., 1947: Life tables for natural populations of animals. *Q. Rev. Biol.* **22**, 283-314.
- DICKENMANN R., 1982: Genetisch-ökologische Untersuchungen an *Ranunculus montanus* Willd. s.l. aus der alpinen Stufe von Davos (Graubünden). *Veröff.Geobot.Inst.ETH,Stiftung Rübel,Zürich* **78**, 89 pp.
- DYER A.F., 1963: The use of lacto-propionic orcein in rapid squash methods for chromosome preparations. *Stain.Techn.* **38**, 85-90.
- ELLENBERG H., 1958: Bodenreaktion (einschliesslich Kalkfrage). In: RUHLAND W. (ed.), *Handbuch der Pflanzenphysiologie*. Springer, Göttingen. 638-708.
- FOSSATI A., 1980: Keimverhalten und frühe Entwicklungsphasen einiger Alpenpflanzen. *Veröff.Geobot.Inst.ETH,Stiftung Rübel,Zürich* **73**, 193 pp.
- GASSER M., 1981: Differenzierungsmuster von Pflanzenarten, die auf verschiedenen Gesteinsunterlagen wachsen. Diplomarbeit. *Geobot.Inst.ETH, Stiftung Rübel,Zürich*. 143 pp. (unpubl.).
- GASSER M., 1983: Zum demographischen Verhalten von *Biscutella levigata* L. *Ber.Geobot.Inst.ETH,Stiftung Rübel,Zürich* **50**, 67-85.
- GIGON A., 1971: Vergleich alpiner Rasen auf Silikat- und auf Karbonatböden, Konkurrenz- und Stickstoffformenversuche sowie standortskundliche Untersuchungen im Nardetum und Seslerietum bei Davos. *Veröff.Geobot. Inst.ETH,Stiftung Rübel,Zürich* **48**, 159 pp.
- GRANT V., 1963: *The origin of adaptations*. Columbia Univ.Press, New York. 606 pp.
- GRANT V., 1981: *Plant speciation*. (2nd ed.). Columbia Univ.Press, New York. 563 pp.
- GRANT V., 1985: *The evolutionary process*. Columbia Univ.Press, New York. 500 pp.
- GREIG-SMITH P., 1983: *Quantitative plant ecology*. (3rd ed.). Blackwell Sci.Publ., Oxford. 353 pp.
- HANDEL S.N., 1983: *Pollination ecology, plant population structure, and*

- gene flow. In: REAL L., (ed.), *Pollination biology*. Academic Press, Orlando. 163-211.
- HARBERD D.J., 1961: Observations on population structure and longevity of *Festuca rubra* L. *New Phytol.* **60**, 184-206.
- HARPER J.L., 1967: A Darwinian approach to plant ecology. *J.Ecol.* **55**, 247-270.
- HARPER J.L., 1977: *Population biology of plants*. Academic Press, London. 892 pp.
- HARPER J.L., 1978: The demography of plants with clonal growth. In: FREYSEN A.H.J. and WOLDENDORP J.W. (eds.), *Structure and functioning of plant populations*. North.Holland Publ.Comp., Amsterdam. 27-48.
- HARPER J.L. and WHITE J., 1974: The demography of plants. *Ann.Rev.Ecol. Syst.* **5**, 419-463.
- HESS H.E., LANDOLT E. and HIRZEL R., 1976-1980: *Flora der Schweiz und angrenzender Gebiete*. (2nd ed.). Birkhäuser, Basel. 3 Vols, 2690 pp.
- KAY Q.O.N., 1978: The role of preferential and assortative pollination in the maintenance of flower colour polymorphisms. In: RICHARDS A.J. (ed.), *The pollination of flowers by insects*. Linnean Society Symposium Series **6**, 175-190.
- KERSTER H.W., 1964: Neighborhood size in the rusty lizard, *Sceloporus olivaceus*. *Evolution* **18**, 445-457.
- KERSTER H.W., 1968: Population age structure in the prairie forb, *Liatris aspera*. *Bio Science* **18**, 430-432.
- KRÜSI B., 1981: Phenological methods in permanent plot research. *Veröff. Geobot.Inst.ETH,Stiftung Rübel,Zürich* **75**, 115 pp.
- LANDOLT E., 1971: Oekologische Differenzierungsmuster bei Artengruppen im Gebiet der Schweizerflora. *Boissieria* **19**, 129-148.
- LEVIN D.A., 1973: The age structure of a hybrid swarm in *Liatris* (Compositae). *Evolution* **27**, 532-535.
- LEVIN D.A. and KERSTER H.W., 1968: Local gene dispersal in *Phlox*. *Evolution* **22**, 130-139.
- LEVIN D.A. and KERSTER H.W., 1969: The dependence of bee-mediated pollen and gene dispersal upon plant density. *Evolution* **23**, 560-571.
- LLOYD D.G. and YATES J.M.A., 1982: Intrasexual relation and the regulation of pollen and stigmas in hermaphroditic plants, exemplified by *Wahlenbergia albomarginata* (Campanulaceae). *Evolution* **36**, 903-913.
- MANTON I., 1934: The problem of *Biscutella laevigata* L. *Zeitschr.Indukt. Abstammungs- und Vererbungslehre, Berlin* **67**, 41-57.
- MANTON I., 1937: The problem of *Biscutella laevigata* L. II. The evidence from meiosis. *Annals of Botany n.s.* **1**, 439-460.
- MARCHAND P.J., 1984: Plant establishment by sexual reproduction in disturbed alpine tundra, White Mountains, New Hampshire (USA). *Doc.Ecol. Pyrénéenne III-IV*, 249-255.
- MARCHAND P.J. and ROACH D.A., 1980: Reproductive strategies of pioneering alpine species: Seed production, dispersal and germination. *Arctic and Alpine Research* **12**, 137-146.
- MÜLLER-SCHNEIDER P., 1977: *Verbreitungsbiologie (Diasporologie) der Blütenpflanzen*. (2nd ed.). *Veröff.Geobot.Inst.ETH,Stiftung Rübel,Zürich* **61**, 226 pp.
- POOLE A.L. and CAIRNS D., 1940: Botanical aspect of ragwort (*Senecio jacobaea* L.) control. *Bull.N.Z.Dep.Sci.Industr.Res.* **82**, 1-66.
- PETROVSKII V.V., 1961: Sinusies as forms of joint existence of plants (in Russian). *Bot.Zh.* **46**, 615-626.
- RABOTNOV T.A., 1978: On coenopopulation by plants reproducing by seeds In: FREYSEN A.H.J. and WOLDENDORP J.W. (eds.), *Structure and functioning of plant populations*. North Holland Publ.Comp., Amsterdam. 1-26.

- RICHARDS A.J. and IBRAHIM H., 1978: Estimation of neighbourhood size in two populations of *Primula veris*. In: RICHARDS A.J. (ed.), The pollinations of flowers by insects. Linnean Society Symposium Series 6, 165-174.
- SARUKHAN J. and HARPER J.L., 1973: Studies on plant demography: *Ranunculus repens* L., *R. bulbosus* L., and *R. acris* L. I. Population flux and survivorship. *J.Ecol.* 61, 675-716.
- SCHELLNER R.A. NEWELL S.J. and SOLBRIG O.T., 1982: Studies on the population biology of the genus *Viola*. IV. Spatial pattern of ramets and seedlings in three stoloniferous species. *J.Ecol.* 70, 273-290.
- SCHÜTZ M., 1983: Keimverhalten und frühe Lebensphasen alpiner Pflanzen von Silikat- und Karbonatschuttstandorten. Diplomarbeit. Geobot.Inst. ETH, Stiftung Rübel, Zürich, 123 pp. (unpubl.).
- SCHÜTZ M. and URBANSKA K.M. 1984: Germinating behaviour and growth potential in *Taraxacum alpinum* (2n=32) from the Swiss Alps. *Ber.Geobot. Inst.ETH,Stiftung Rübel,Zürich* 51, 118-131.
- TAMM C.O., 1948: Observations on reproduction and survival of some perennial herbs. *Bot.Not.* 101, 305-321.
- TAMM C.O., 1972a: Survival and flowering of some perennial herbs. II. The behaviour of some orchids on permanent plots. *Oikos* 23, 23-28.
- TAMM C.O., 1972b: Survival and flowering of some perennial herbs III. The behaviour of *Primula veris* on permanent plots. *Oikos* 23, 159-166.
- THOMAS A.G. and DALE H.M., 1975: The role of seed reproduction in the dynamics of established populations of *Hieracium floribundum* and a comparison with that of vegetative reproduction. *Canad.J.Bot.* 53, 3022-3031.
- URBANSKA K.M., 1980: Reproductive strategies in a hybridogenous population of *Cardamine* L. *Acta Oecol.,Oecol.Plant* 1(15), 137-150.
- URBANSKA K.M. and LANDOLT E., 1978: Recherches démographiques et écologiques sur une population hybridogène de *Cardamine* L. *Ber.Geobot. Inst.ETH,Stiftung Rübel,Zürich* 45, 30-53.
- URBANSKA K.M. and SCHWANK O., 1980: Variation within *Lotus corniculatus* L. s.l. from Switzerland. III. Microdifferentiation in *L. alpinus* (DC.) Schleicher above the timberline. *Ber.Geobot.Inst.ETH,Stiftung Rübel,Zürich* 47, 29-45.
- VALENTINE D.H., 1962: La taxonomie expérimental: Tendences actuels. *Rev. Cytol.Biol.Vég.* 25, 255-266.
- WALTER H. and LIETH H., 1960/67: Klimadiagramm Weltatlas. Fischer, Jena.
- WEBB C.J. and BAWA K.S., 1983: Pollen dispersal by hummingbirds and butterflies: A comparative study of two lowland tropical plants. *Evolution* 37, 1258-1270.
- WEILENMANN K., 1981: Bedeutung der Keim- und Jungpflanzenphase für alpine Taxa verschiedener Standorte. *Ber.Geobot.Inst.ETH,Stiftung Rübel, Zürich* 48, 68-119.
- WHITE M.J.D., 1978: Modes of speciation. W.H.Freemann and Co., San Francisco. 455 pp.
- WRIGHT S., 1943: Isolation by distance. *Genetics* 28, 114-138.
- WRIGHT S., 1946: Isolation by distance under diverse systems of mating. *Genetics* 31, 39-59.
- WU L. and ANTONOVICS J., 1976: Experimental studies in *Plantago*. II. Lead tolerance in *Plantago lanceolata* and *Cynodon dactylon* from a roadside. *Ecology* 57, 205-208.
- ZIMMERLI S., 1983: Einfluss der Bewirtschaftung auf die Entwicklung und Struktur der *Cardamine*-Populationen auf dem Urnerboden. Diplomarbeit. Geobot.Inst.ETH,Stiftung Rübel,Zürich, 142 pp. (unpubl.).
- ZUUR-ISLER D., 1982: Germination behaviour and early life phases of some

species from alpine serpentine soils. Ber.Geobot.Inst.ETH,Stiftung  
Rübel,Zürich 49, 76-107.

Adresse des Autors: Max GASSER, dipl.Natw.ETH  
Geobotanisches Institut ETH  
Stiftung Rübel  
Zürichbergstrasse 38  
  
CH-8044 Zürich