

Zeitschrift: gta papers
Herausgeber: gta Verlag
Band: 1 (2017)

Artikel: The museum in motion : two projects by Made in
Autor: Erb, Tobias
DOI: <https://doi.org/10.5169/seals-791258>

Nutzungsbedingungen

Die ETH-Bibliothek ist die Anbieterin der digitalisierten Zeitschriften. Sie besitzt keine Urheberrechte an den Zeitschriften und ist nicht verantwortlich für deren Inhalte. Die Rechte liegen in der Regel bei den Herausgebern beziehungsweise den externen Rechteinhabern. [Siehe Rechtliche Hinweise.](#)

Conditions d'utilisation

L'ETH Library est le fournisseur des revues numérisées. Elle ne détient aucun droit d'auteur sur les revues et n'est pas responsable de leur contenu. En règle générale, les droits sont détenus par les éditeurs ou les détenteurs de droits externes. [Voir Informations légales.](#)

Terms of use

The ETH Library is the provider of the digitised journals. It does not own any copyrights to the journals and is not responsible for their content. The rights usually lie with the publishers or the external rights holders. [See Legal notice.](#)

Download PDF: 08.02.2025

ETH-Bibliothek Zürich, E-Periodica, <https://www.e-periodica.ch>

The Museum in Motion: Two Projects by Made in Tobias Erb

Today, the art museum is trapped between its desire for a distinctive visual profile for which the architect takes authorship, and the obligation to respect a whole range of programmatic specifications drawn up by anonymous specialists. Correspondingly, the task of the architect during the design process remains categorically distinct from any challenging curatorial, institutional, or technical demands. In its recent design competition entries for two prominent museums in Switzerland, the Geneva-based architecture office Made in called into question this state of affairs and ultimately renegotiated the competition brief precisely in this regard. Its proposals for the new *Musée Cantonal des Beaux-Arts Lausanne* and an extension to the *Kunstmuseum Basel* evince a new angle on the art museum, treating it not from the traditional perspective, as a private collection or scholarly cabinet, but rather as a locus of collective experience. They understand the art museum as an apparatus that actively generates knowledge and explore the alternative ways in which art works might be staged.

In Lausanne, this culminated in a novel layout for the new *Musée Cantonal des Beaux-Arts*. The exhibition space comprises four cylindrical towers set at the corners of a public park. Rather than floors, each tower is equipped with a lifting platform that

vertically transports visitors from the ground-level entrance through the exhibitions, whereby the permanent collection is displayed on the walls and temporary exhibitions on the lifting platform itself. Once at the top, visitors take exterior elevators straight back down to the park before proceeding to the next tower to repeat the process. This alternative to the classic horizontal perambulation is not only a literal interpretation of the program specifications, such as to provide the greatest ratio of wall space to floor space, but also fundamentally alters the exhibition and viewing scenarios. On the one hand the

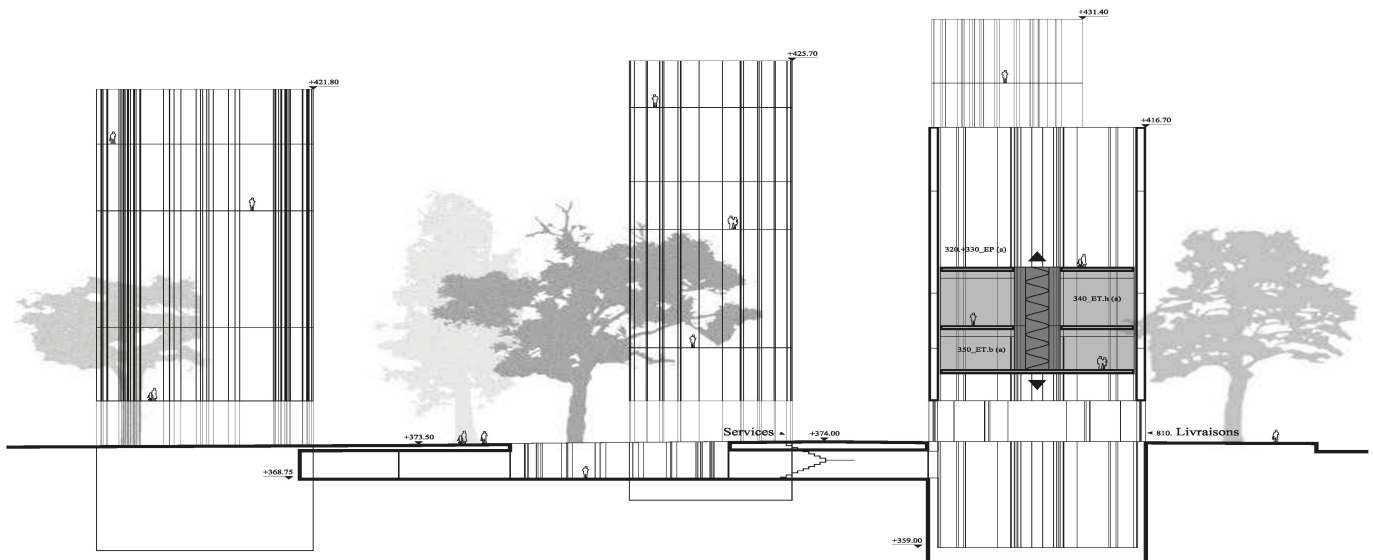

movement of the lifting platform enables the permanent collection to be viewed in individual scenarios, and on the other sets it in a shifting relationship to the temporary exhibitions.

A similar principle underpins Made in's proposal for an extension to the Kunstmuseum Basel, where the architects understood their remit as being not only to enlarge the museum, but also to expand its

potential. The existing building, with its traditional enfilade for the permanent collection, was complemented by the addition of a new one for temporary exhibitions. This consists of modular wall and floor elements suspended from a large roof construction, and can thus be flexibly configured as rooms, galleries, or cabinets, enabling new forms of staging to be explored. Visitors' movement between these two self-contained buildings assures the unity of the permanent collection and the temporary exhibitions, as required by the program. The primary access point is still the entrance to the original building, from where it is possible to undertake a tour of the various sections, the tour being articulated by a series of escalators, lifts, or revolving doors. These elements are so arranged as to allow the works of art and the exhibitions to be placed in different relationships to one another, thus opening up shifting scenarios.

Although the architectural dispositions of the two projects differ, they nevertheless have a core factor in common, namely the involvement of mechanical elements in the form of lifting platforms, escalators, elevators, or revolving doors. These serve to explicate the idea of the museum as an apparatus: not merely by directly facilitating constantly new encounters between the viewer and the object, but also superordinately, inasmuch as they lend the art museum a new dimension of temporality. The primary emphasis of the design shifts therefore to performance and

potentialities – to a museum that is judged not so much by its appearance as by the availability and range of its scenarios. Made in's contributions to the competitions for the new Musée Cantonal des Beaux-Arts Lausanne and the extension to the Kunstmuseum Basel negotiate not only a new architectural paradigm for the art museum per se, but also a new perspective for architects. They see the definition of the programmatic specifications as part of the design process, thus tapping into the architectural potential embodied in the competition brief while simultaneously transcending the role commonly prescribed for architecture in it. The specialists may draw up precise specifications, but it is the task of the architect to invest them with meaning.

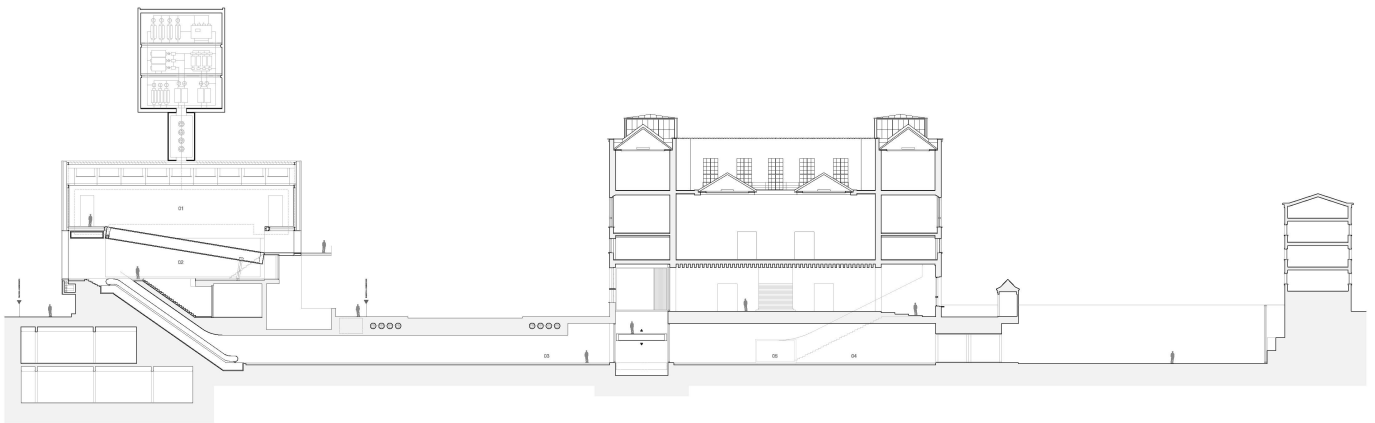

f.1 Made in, Geneva, new Musée Cantonal des Beaux-Arts Lausanne, competition 2004, section.
f.2 Made in, Geneva, extension Kunstmuseum Basel, competition 2009, section.

Viollet-le-Duc's Organic Machine

Martin Bressani

In his last didactic children's novella, *Histoire d'un dessinateur: Comment on apprend à dessiner*, published posthumously in December 1879, the celebrated French neo-Gothic architect and theoretician Eugène Emmanuel Viollet-le-Duc illustrated a mechanized artificial limb, showing how the workings of muscles and tendons in animals can be used as model for mechanical devices. ^{f.1} It served as conclusion to two successive anatomy lessons featuring the two main protagonists of the short novella – the

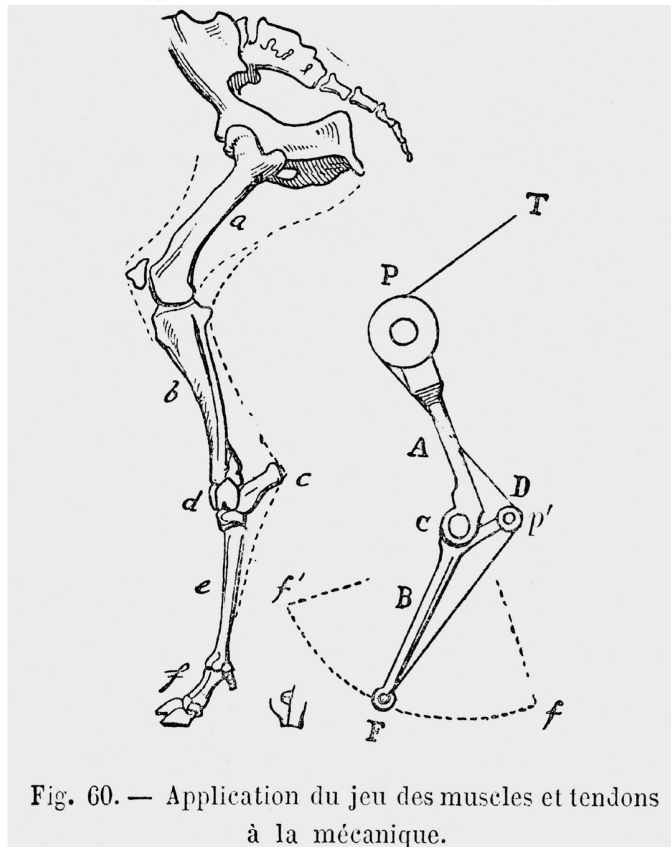

Fig. 60. — Application du jeu des muscles et tendons à la mécanique.

industrialist Majorin and his young protégé petit Jean. Through the study of anatomy, explains Majorin to his pupil, one can gain a new appreciation of machines in factories, “for man, in the arts of mechanization, seldom does more than apply these anatomical elements.” He adds that “one could write a whole treatise on mechanics, taking as the sole subject the curvature of the bones,” and goes on to lament that man will never be able to achieve the ultimate goal of producing

a creature with the same level of autonomy as a living being. But by using organic models to shape mechanisms, Viollet-le-Duc hints at a possible continuity between machines and humans. As he describes it: “the organs of [man’s] best machines are generally made in conformity to the principles by which his body moves.” ¹

A reversal of the traditional (Cartesian) relationship between Body and Machine, Viollet-le-Duc’s striking drawing is, to my knowledge, unique in the annals of nineteenth-century technical illustrations. We are of course familiar with the mechanist explanation of organic phenomena from the long-standing Cartesian tradition, but the reverse idea – that machines should be modeled upon organisms – is highly unusual before the twentieth century. It is worth pondering such early manifestation of the coupling of machine and organism in the work of one of the

Martin Bressani is Professor and Director of McGill University’s School of Architecture.

Note: This essay is the last of a trilogy of texts I have written on the *Histoire d'un dessinateur*, which partly overlap but complement each other. The two others are 1, the concluding chapter of my *Architecture and the Historical Imagination: Eugene-Emmanuel Viollet-le-Duc 1814–1879* (Farnham [Surrey, UK]: Ashgate Publishing Limited, 2014), pp. 499–519; and 2, the article “Prosthetic Fantasies of the First Machine Age: Viollet-le-Duc’s Iron Architecture,” *AA Files*, 68 (2014), pp. 43–9.

f.1 Eugène Emmanuel Viollet-le-Duc. The working of muscles and tendon applied to a mechanical device. Woodcut engraving.

¹ [Eugène Emmanuel] Viollet-le-Duc, *Histoire d'un dessinateur: Comment on apprend à dessiner* (Paris: J. Hetzel, [1879]), pp. 131–5. English translation by Virginia Champlin, *Learning to Draw; or, The Story of a Young Designer* (New York, NY: Putman, 1881). All translations from *Histoire d'un dessinateur* are based on this edition, but I emended them whenever I felt it was necessary in order to render more accurately Viollet-le-Duc’s original meaning. All further translations are my own.

f.2 Plate IV of Giovanni Alfonso Borelli's *De Motu Animalium*, 1680.

2 See, for instance, Andy Pickering, "Cyborg History and the World War II Regime," *Perspectives on Science*, 3, no. 1 (1995), pp. 1–48.

3 Viollet-le-Duc, *Histoire d'un dessinateur* (see note 1), p. 128.

4 Viollet-le-Duc had a precious edition of Borelli's famous book in his library: *De Motu Animalium*, Editio novissima auctior et emendatior (Hagae Comitum: Apud petrum Gosse, 1743). See item 1134 in *Catalogue des livres composant la bibliothèque de feu M. E. Viollet-le-Duc* (Paris: Labitte, 1880), p. 148.

5 See my extended discussion of these poetic fantasies in *Architecture and the Historical Imagination* (see preliminary note), pp. 415ff.

6 Samuel Butler, *Erewhon; or, Over the Range* (London: Trübner, 1872), p. 221.

key theoreticians of modernism. Is Viollet-le-Duc anticipating the destabilization of the boundary between the human and the non-human that has been often associated with post-Second World War developments and the concept of cybernetic organisms? ² Or is his mechanized limb simply a confusion of terms, a late avatar of the traditional Cartesian theory of the animal-machine? After all, in the same novella, Viollet-le-Duc does describe the human body as a machine mechanism. ³ And the closest precedent to his image of a mechanized limb are plates from *De Motu Animalium* (On the Movement of Animals, 1681), the magnum opus of Italian Renaissance physiologist and "bio-mechanist" Giovanni Alfonso Borelli, which, in classic Cartesian fashion, relates animals to machines using geometry and mathematics to prove his theories. ^{4/f.2}

Before delving further within Viollet-le-Duc's own argument to shed light on these questions, it is useful to first establish if there were other nineteenth-century instances of this reversal of the traditional Cartesian relation between mechanism and organism. To be sure, poetic fantasies about machines, comparing locomotives to dragons and other beastly forms, were common in nineteenth-century literature. ⁵ And British novelist Samuel Butler, in his famous dystopian novel *Erewhon; or, Over the Range* (1872), described man "as a machinate mammal." ⁶ But these literary takes on the world of mechanization, while significant in their own right, are of limited use if we seek to understand the conceptual turn that led to the reversal of the Cartesian analogy of organism/machine.

In a well-known lecture titled "Machine and Organism" dating from 1947, French philosopher and physician Georges Canguilhem provides us with useful insights for tracking conceptual sources. He explains that the reversal first originated in inquiries attentive to the relationship between the production

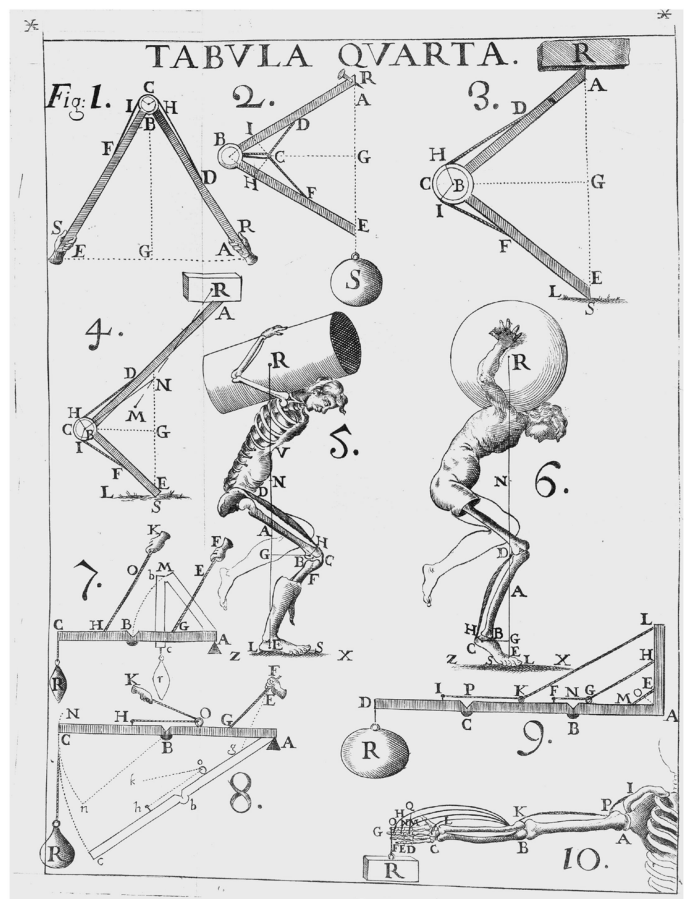

of primitive tools and organic activity itself, in other words, in reflections on the historical sources of technological phenomena. It is through such an “ethnological” outlook, claims Canguilhem, that tools and, by extension, machines came to be considered as prolongations of the organs of the human species. He identifies Ernst Kapp’s theory of “organ projection,” developed in the latter’s *Grundlinien einer Philosophie der Technik* (1877), as the initiator of such organic understanding of technology. Within the French context, he points to philosopher Alfred Espinas’s *Les origines de la technologie* (1897) as the first to have followed Kapp’s lead. ⁷

If Kapp and Espinas were indeed pioneers in elaborating full-fledged theories of tools or machines as organic projections, they were not the only ones to have given expression to the concept in the nineteenth century, as the *Histoire d’un dessinateur* already bears witness. Using Viollet-le-Duc’s work and its own complex network of sources as a thread, this article will serve to further flesh out Canguilhem’s classic essay of 1947 by expanding its insights in several directions—first by identifying ethnographic precedents, as he suggested, but also other sources in Romantic vitalist philosophies, neo-Catholic doctrine, and anatomical studies.

The earliest nineteenth-century expression of a biological take on human technique—some version of the idea had already been articulated in the seventeenth century ⁸—is probably the short sentence (quoted by Kapp) at the end of the second volume of Alexander von Humboldt’s illustrious masterpiece *Kosmos: Entwurf einer physischen Weltbeschreibung*, published in 1847: “The creation of new organs or instruments of observation,” writes Humboldt, “augments the intellectual, and often the physical powers of man.” ⁹ Humboldt’s immensely popular five-volume panorama on science and the universe sought to establish, in classic Romantic fashion, a unifying perspective on the studies of science, nature, and mankind. Its impact was immense, including in France, where it was translated almost immediately. It may have influenced the work of pioneer prehistoric archaeologist Jacques Boucher de Perthes, the first in France to clearly express the idea that tools are extensions of human organs. In *Des outils de pierre*, a pamphlet published in 1865 on Stone-Age tools, he asserts that primitive tools were “a consequence of [man’s] physical constitution, a sort of addition to ourselves or a supplementary organ [*membres supplémentaires*],” ¹⁰ a claim which he illustrates with plates showing how primitive flints fitted exactly the contour of the hand and thus prolonged and extended the arm’s organic movement of percussion. The remark

⁷ Georges Canguilhem, “Machine and Organism,” in Canguilhem, *Knowledge of Life*. Trans. Stefanos Geroulanos and Daniela Ginsburg (New York: Fordham University Press, 2008), pp. 75–97; here p. 93.

⁸ The idea that scientific instruments (not tools per se) are extensions of natural human organs may have been a current assumption within the Royal Society in seventeenth-century England, at least judging from the following passage in Robert Hooke’s *Micrographia* of 1665: “The next care to be taken, in respect of the Senses, is a supplying of their infirmities with *Instruments*, and, as it were, the adding of *artificial Organs* to the natural;” Robert Hooke, “Preface,” in R[obert] Hooke, *Micrographia; or, Some Physiological Descriptions of Minute Bodies Made by Magnifying Glasses with Observations and Inquiries Thereupon* (London: Jo. Martyn and Ja. Allestry, 1665), n.p.

⁹ Alexander von Humboldt, *Cosmos: Sketch of a Physical Description of the Universe*, vol. 2 (London: Longman, Brown, Green & Longmans, 1848), p. 358.

¹⁰ Jacques Boucher de Perthes, *Des outils de pierre* (Paris: Jung-Treuttel, 1865), p. 6.

was far from casual, as Boucher de Perthes had earlier constructed a vast “organology” of the world, developing the idea that human and animal organs are projections of the will, and therefore subject to improvement and metamorphosis. He expounded these ideas in his first substantial work, *De la création: Essai sur l’origine et la progression des êtres* (1838–1841) – a curious five-volume philosophical panorama of the universe which analyses organ formation within the universal metamorphosis of matter towards the creation of organisms with ever increasing perfection. But beyond the brief passage quoted above in *Des outils de pierre*, he never pursued the idea of man’s industrial powers in terms of an organology.

The idea is more fully developed in an apology of industry written in 1884 by a disciple of Auguste Comte, the polymath and historian Louis Bourdeau, in which machines are described as “the equivalent of a new natural kingdom” and “counterfeits of animated beings.”¹¹ This new mechanical order, writes Bourdeau, allows man to adapt his “bodies to functions that nature had not planned.” It “completes our still unfinished organism. [Machines] are like auxiliary organs that we can wear or take off, exchange and modify at will.”¹² In short, claims Bourdeau, “man reproduces and summarizes with his technical artifices all the scattered perfections of the animal kingdom,” an observation that could well have served as caption to Viollet-le-Duc’s mechanized limb modeled on the hind leg of a cervid. Though indebted to Comte’s sociology, Bourdeau’s work is not unrelated to the romanticism of Humboldt and Boucher de Perthes insofar as, like them, he sought to establish a general philosophical synthesis of nature in which to place man. His most ambitious philosophical work, *Le problème de la vie: Essai de sociologie générale* (1901) was an attempt at a monistic science that sought to identify a general principle of life active in both the natural and human world.

This brief and no doubt very partial account of early expressions of the organic understanding of machines, especially in France, clarifies the structure of thought and attitudes from which the reversal of the traditional Cartesian relation between mechanism and organism could be effected. Confirming Canguilhem’s insight, it was by considering the unconscious creative impulse behind the generation of machines, or their “irrational origin” to use Canguilhem’s own expression, that technique could come to be understood as a biological phenomenon.¹³ Once conceived as a natural behavior of the living, or of life in general, machines naturally aligned themselves, so to speak, with the functioning of the human body. They became its extension, or its “organ projection,” to use Kapp’s stunning formulation.

11 Louis Bourdeau, *Les forces de l’industrie: Progrès de la science humaine* (Paris: Félix Alcan, 1884), pp. 233–4.

12 *Ibid.*, pp. 45–6.

13 Canguilhem, “Machine and Organism” (see note 7), p. 95.

There is some basis to suppose that Viollet-le-Duc was acquainted with the work of Humboldt and Boucher de Perthes, if not Bourdeau.¹⁴ But whether he knew these authors or not, we can trace the same set of attitudes in his own life-long inquiry into the nature of creativity at work simultaneously in both the natural and human world. His theory of *style*, which is his term to denote such creative impulse, is couched in a celebration of nature's generative principle, demonstrating how authentic (as opposed to degenerate) human creation must be understood by way of analogies with the formative powers of nature. In the article "Style" of his great *Dictionnaire raisonné de l'architecture française du XIe au XVIe siècle* he refers, at some point, to the machine as the paradigm of an object endowed with style—"the machine is the exact expression of the function it fulfills; us, artists, need not go any further"¹⁵—but the examples he uses are the wings of a bird and the curve of the body of a fish. It is not an abstract engineering logic that matters to him, but a natural, organic process of formation. To be legitimate, human creations must be the product of a true creative act, a pure expression of the will.¹⁶ Despite being so often categorized as a rationalist, Viollet-le-Duc, who was above all an archaeologist given to general reflections on man's historicity, believed that authentic human technique stemmed from a vital originality irreducible to pure rationalization. He had no patience with the new mathematization of technical knowledge by modern engineers, while he took great care, as we will see, to study the gesture and body postures of craftsmen, soldiers, and other men of action, particularly from the Middle Ages, his privileged domain of historical inquiry.

Anatomy as a science-principe

What distinguishes Viollet-le-Duc's juxtaposition of organism and machine from the authors just reviewed, however, is that in the *Histoire d'un dessinateur* it assumes the status of a method, a precise and functional exchange between organism and machine. The industrialist, according to Majorin, must study anatomy to create his machines, animal limbs serving as direct inspiration for machine mechanisms. The fact that Viollet-le-Duc chose to illustrate how mechanism can be modeled upon animals is highly significant: the organic was to form part of the imaginary of future industrialists. For Viollet-le-Duc, who enjoyed the work of old Renaissance masters and scientists, such as Leonardo (whom he discusses directly in the *Histoire d'un dessinateur*),¹⁷ and Borelli, whose curious anatomical treatise on the movement of animals he purchased,¹⁸ anatomy had acquired

14 Viollet-le-Duc greatly admired Alexander von Humboldt, as he himself states in several publications (see [Eugène Emmanuel] Viollet-le-Duc, "Antiquités américaines," in Désiré Charnay, *Cités et ruines américaines* (Paris: Gide et Morel, 1863), pp. 3–104; here pp. 3–4, and [Eugène Emmanuel] Viollet-le-Duc, *Mémoires sur la défense de Paris: Septembre 1870—Janvier 1871* (Paris: Morel, 1871), p. 72. It is extremely likely that he was acquainted with the work of archaeologist Boucher de Perthes, who was close to his own father and to Napoleon III. As for the young Louis Bourdeau, he may have met him in the positivist circles in which he moved in the 1870s—though that is highly conjectural.

15 [Eugène Emmanuel] Viollet-le-Duc, *Dictionnaire raisonné de l'architecture française du XIe au XVIe siècle*, vol. 8 (Paris: Morel, 1866), p. 488.

16 See my extended discussion of Viollet-le-Duc's idea of "style" in *Architecture and the Historical Imagination* (see preliminary note), pp. 381–92.

17 Viollet-le-Duc, *Histoire d'un dessinateur* (see note 1), pp. 205–8.

18 See note 4.

the status of a *science-principe*. It was a primordial resource for those who like to ponder the hidden springs of the universe, an ancient knowledge that seeped through time through the work of kindred spirit.

That ancient knowledge formed of course the backbone of his earlier writings on architecture. In his ten-volume *Dictionnaire raisonné de l'architecture française*, Viollet-le-Duc developed a biological idiom for architecture. In the preface to volume one dating from 1854, Viollet-le-Duc affirms "that the moment has arrived to study the art of the Middle Ages like one studies the development and the life of a living being [*la vie d'un être animé*]." ¹⁹ His magnum opus is indeed an anatomy treatise of medieval architecture, with its thousands of illustrations dissecting the "organs" of monasteries, castles, and especially cathedrals. Viollet-le-Duc compares the latter's "interior organization" to the human body, "complexifying and developing as it progressively contains a greater number of crucial organs." ²⁰ Viollet-le-Duc renewed with the Vitruvian body metaphor but corrected its meaning in claiming that the translation of the human body into architecture was no longer conceived as the product of an imitative process, as in the classical tradition, but of an instinctive projection of man's bodily organization.

His own sources for the idea that architecture, or art more generally, is a form of incorporation can be traced to the ideological foundations of the French neo-Gothic movement, most notably to the writings and teaching of physician, philosopher, historian, and socialist Christian, Philippe Joseph Benjamin Buchez, whose "school" met next door to Viollet-le-Duc's family house on rue Chabanais in Paris. And Buchez's work sheds an interesting light on the question of an instinctive "body projection." As many other proponents of a return to *l'art chrétien*, he saw human creation as a form of incarnation modeled on that of Jesus. Man's highest creative act proceeded through an overwhelming sense of a unified bodily consciousness, obliterating memory and habit while disclosing a new historical truth. ²¹ Viollet-le-Duc was exposed to these ideas very early through his participation in the Institut historique de Paris in the 1830s, a learned society dominated, from the start, by Buchez's school. ²² But he probably assimilated Buchez's teaching more thoroughly through his friendship with the anatomist and medical doctor Jean-Marc Bourgery, himself probably a disciple of Buchez (whom he quotes repeatedly), and author of the monumental *Traité complet de l'anatomie de l'homme* (1831–1854), generally recognized as the most lavish human anatomy treatise produced in the nineteenth century. The heavy tomes were by far

¹⁹ [Eugène Emmanuel] Viollet-le-Duc, *Dictionnaire raisonné de l'architecture française du XI^e au XVI^e siècle*, vol. 1 (Paris: Bance, 1854), p. vi.

²⁰ *Ibid.*, p. 149. Emphasis in original.

²¹ Philippe Buchez, *Introduction à la science de l'histoire ou science du développement de l'humanité* (Paris: Paulin, 1833), pp. 194–5.

²² For an extended discussion of Viollet-le-Duc's ties to Buchez, see my doctoral dissertation, "Science, histoire et archéologie. Sources et généalogie de la pensée organicienne de Viollet-le-Duc" (PhD, Université de Paris-Sorbonne Paris IV, 1997), pp. 153–68.

the most prominent work on natural sciences in Viollet-le-Duc's own library. An attentive reading of the *Traité complet* draws the reader into the convolutions typical of Romantic biology. Bourgery opens his *Traité* by establishing the model of the ideal human body—a normative model which, as I have argued elsewhere,²³ is not unlike Viollet-le-Duc's "ideal" cathedral in his *Dictionnaire raisonné de l'architecture*.²⁴ Following in the footsteps of Buchez, the real body is the model, but a body seized at its maximum level of vitality, product of the perfect equilibrium between the material and the spiritual. Not surprisingly, Bourgery's text integrates the notions of instinct and race as determinant agents. "It is through his spiritual self, transmissible through the race, that are produced, thanks to the collective work of generations, all great manifestations of the spirit."²⁵ And just as we have seen in Buchez (and Viollet-le-Duc), Bourgery would be led to see human creations as a form of exteriorization of the body, in a way which anticipates Ernst Kapp's theory of projection:

*"In all applications of the mind within the external world, the organism does but copy itself, transposing itself, as it were, and imposing itself upon nature. ... [M]an does not precisely invent anything, since he imagines only what he senses within himself, applying to the outside what he is, or what he has been made inside."*²⁶

²³ See Bressani, *Architecture and the Historical Imagination* (see preliminary note), pp. 277–88.

²⁴ Jean-Marc Bourgery, *Traité complet de l'anatomie de l'homme*, vol. 1 (Paris: Delaunay, 1832), p. 3.

²⁵ *Ibid.*, vol. 3 (1844), p. 18.

²⁶ *Ibid.*, p. 24.

The soldier-weapon

Despite obvious continuities, we need to be aware that there is a significant distance between Viollet-le-Duc's reflections on architecture from the 1850s and 1860s and the mechanized limb he illustrated in 1879. He had relatively little interest in mechanization before the late 1860s, if we except his great fascination with medieval war machines, which he describes in great detail over 50 pages in volume five of his *Dictionnaire raisonné de l'architecture* (1861). The shift from architecture to mechanization seen in the *Histoire d'un dessinateur* was not a casual swing of interest, but reflected a changed perspective. The key factor for this transformation was the disastrous Franco-Prussian War (1870–1871), the first military conflict, together with the American Civil War and the Austro-Prussian War, to have clearly displayed aspects of industrial warfare. Viollet-le-Duc was fully conscious of that new reality, as his fascinating *Mémoires sur la défense de Paris: Septembre 1870—Janvier 1871* bears witness. An exposition of his thoughts on what France should have done (and should do in the future) to win the war against Germany, the *Mémoires* lay out the new requirements of modern warfare. It is now a vast "enterprise," described Viollet-le-Duc, which, like

industrial production, requires an efficient administrative organization, a knowledge of how to gain and use capital, and control of the largest number of weapons and the most complete array of resources:

"It is not merely the reorganization of the army that must now be envisaged, but the organization towards battle of the entire forces which a country like France has at its disposal, the potential transformation, at any given time, of all the peacetime productive forces into the destructive forces of warfare. ... Industry – and this was proven [in the Franco-Prussian war] – produces as easily war engines as instruments for peace. The special knowledge of engineers, geographers, physicians, chemists, must be used equally for the one and the other." ²⁷

²⁷ Viollet-le-Duc, *Mémoires sur la défense de Paris* (see note 14), pp. 226–7.

From there on, the ardent patriot in Viollet-le-Duc would focus on education, and seek to reach out directly to "the children of all classes," as he himself put it to his publisher Jules Hetzel, teaching the young people of France how to think, reason, and muster the energy "to get up in the morning and set to work." ²⁸ The *Histoire d'un dessinateur* is the last and ultimate product of his series of pedagogical publications aimed at such regeneration of the youth. Despite its seemingly benevolent tone, the short novella is entirely couched in this obsessive desire to redress the French nation – an ambition that followed quasi-naturally from his life-long neo-Gothic quest, but now redirected towards industry and France's military future.

²⁸ Passage from a letter from Viollet-le-Duc to his publisher Jules Hetzel, July 20, 1874, Médiathèque de l'architecture et du patrimoine, Paris, "Correspondance et rapports, 1872–75," doc 93.

In this regard, it is useful to review at this point the novella's basic story line. Petit Jean is an 11-year-old country boy, son of père Loupeau, a hard-working gardener and handyman living on the outskirts of Paris. One day the eccentric industrialist, factory-owner Monsieur Majorin, pays a visit and notices a drawing made by petit Jean of his cat. Detecting an unusual level of aptitude, he offers to take full custody of the boy and make him his pupil. Ripped away from the bosom of his natural family as if entering military training, petit Jean is subsequently drilled in various subjects over several chapters. Especially fundamental to this pedagogical experiment is the development of his ability to draw, through which the reader understands he is learning how to see, and therefore to think and reason. Viollet-le-Duc is explicit about what this discipline of seeing entails: the interrogation of one's surroundings in order to rebuild them mentally from the ground up:

"When you see any thing, a piece of furniture, a tool, or a house, you must ask how it is made, with what, and why, and try to guess it yourself. ... When you see an animal, big or little, a horse or a sheep, or an insect or a bird, you must ask what it

does in order to walk, to defend itself, to get sustenance, and to fly. When you see a plant, you must ask how it comes up from the earth, how it pushes forth shoots; and watch closely, and see how the leaves, flowers, and fruit are attached.”²⁹

²⁹ Viollet-le-Duc, *Histoire d'un dessinateur* (see note 1), p. 21.

For petit Jean, the act of seeing and drawing thus becomes a relentless anatomical analysis, an act of reconstruction, as if the world has to be pulled back from the brink of self-destruction and made anew. It was not towards architecture or the arts that Majorin's drawing pedagogy was leading petit Jean, but towards industry or, more generally, towards the development of a new capacity for action. Whereas the Second Empire had engendered a fragmented, decentered self, the youth of France of the Third Republic had now to cohere into a new unity, ready to take control of his environment. And with this control, the passive body of the Second Empire had to give way to a new self, transformed into an active and intelligent part of the larger body of a (regenerated) nation. The development of new organs, in this case visual, was necessary to construct this new living apparatus.

When seen in this context, the reach of Viollet-le-Duc's mechanized limb illustrated in *Histoire d'un dessinateur* is extended quite considerably. Petit Jean's comparative anatomy lessons, which end on the topic of mechanization, come immediately after the crucial chapter titled "Petit Jean Begins to See," in which the young apprentice reached a first degree of awareness of the vitality that runs throughout nature. Only then can the anatomy lessons begin, looking at two rather terrifying creatures — a bat and a Pterodactyl — thus setting the theme of nature's great variety with an undertow of monstrosity before he moves to human anatomy. Once the secret of anatomy is disclosed, petit Jean can gain a more conscious understanding of the productive force of nature and thus be able to see how industrialization can fully assume its role as the creator of a second nature. The organs of men's machines, declares Majorin, must now be made in conformity to the principles of his own body. Majorin describes the human hand as a tool, perfected through evolution, and the human skeleton as a mechanism.³⁰ It is not a return to the old Cartesian paradigm, as the issue is now to link the human body to the machine — a question naturally tied to a first industrial age when the machine progressively took over the human habitus.³¹ Viollet-le-Duc, however, does not conceive the factory as a place of repetitive gestures and nascent Taylorization, but as a living, adaptable apparatus. At any given time, he repeats, France's "civilian organization must be able to transform, within twenty-four hours, into a military organization."³² As a national center of production, industry must be adaptable

³⁰ *Ibid.*, pp. 115, 119, and 128.

³¹ On the link between architecture and eugenics see Georges Teyssot, "Figuring the Invisible," chapter two of his *A Topology of Everyday Constellations* (Cambridge, MA: MIT Press, 2013), pp. 31–82.

³² Viollet-le-Duc, *Mémoires sur la défense de Paris* (see note 14), p. 231.

A

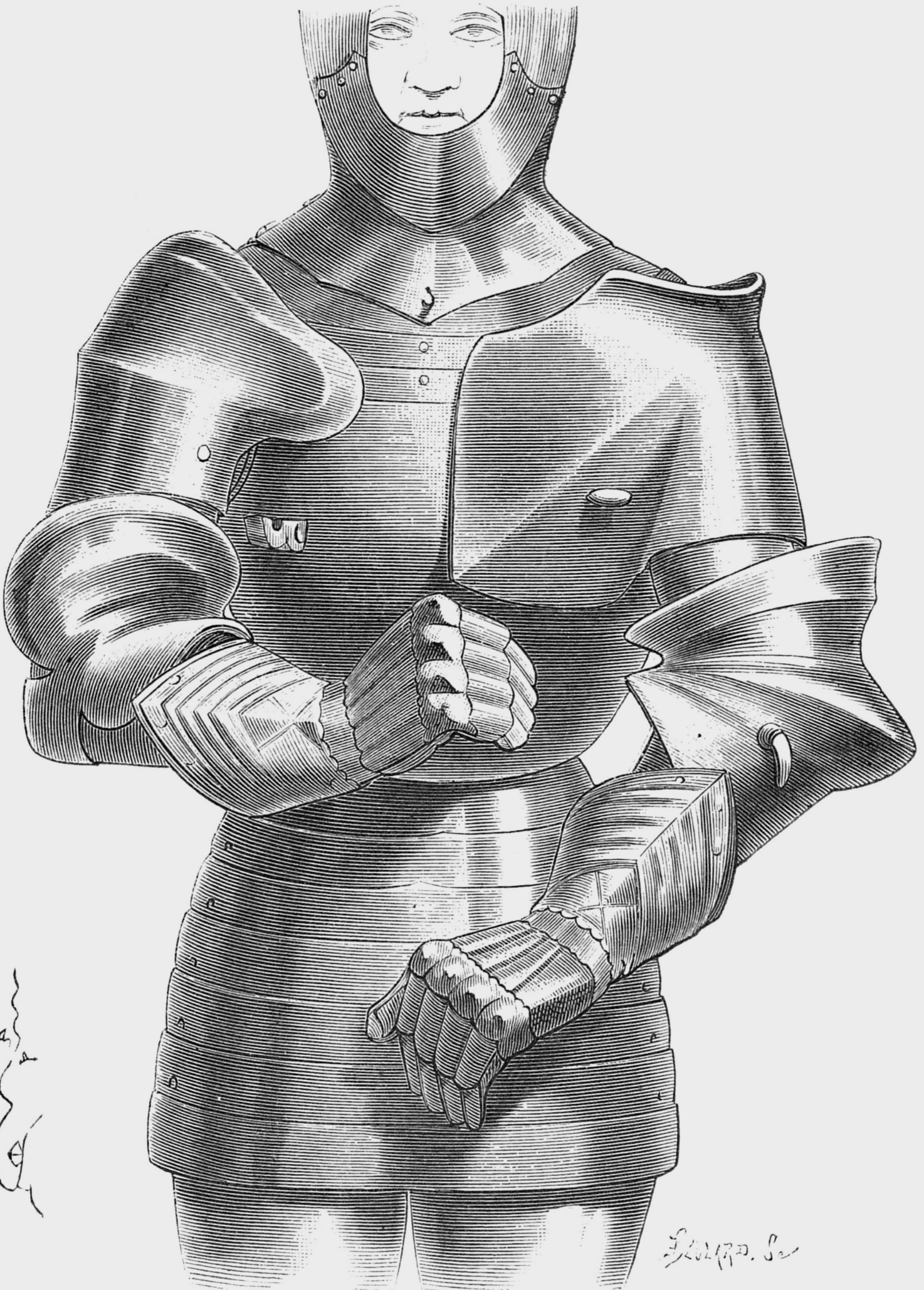

Handwritten scribbles and a small sketch of a face or profile on the left side of the page.

L. S. 1720. Sc.

and vital, a capacity put to the test in times of war. War is indeed the vital regenerator, “the sole agent,” writes Viollet-le-Duc, “capable of conserving the moral energy which gives nation its power and cohesion.”³³

f.3 Eugène Emmanuel Viollet-le-Duc. Fifteenth-century armor. Woodcut engraving.

In the same way, he describes how the modern soldier has become “nothing but a force transmitted to a weapon; the more that weapon will be perfected ... the more man will be reduced to the state of a trigger mechanism.” Yet an absolute mechanized conception of warfare is despicable to him, an ignobility that he associates with the German army. A superior military training assumes that soldiers have “personalized” their weapon, bringing their own “intelligence, prevision, knowledge” into play. Only then can be ensured the “superiority to that horrifying mechanism which we call a weapon.”³⁴ The mechanism, in other words, must always find its place back into living, adaptable, organic life.

33 [Eugène Emmanuel] Viollet-le-Duc, *Dictionnaire raisonné du mobilier français de l'époque carlovingienne à la Renaissance*, vol. 5 (Paris: Morel, 1874), p. 3.

34 *Ibid.*, p. 5.

Such intimate and vital relationship between soldier and weapon is the subject of the entire fifth and sixth volumes of Viollet-le-Duc’s remarkable *Dictionnaire raisonné du mobilier de l'époque carlovingienne à la Renaissance* (1874 and 1875),

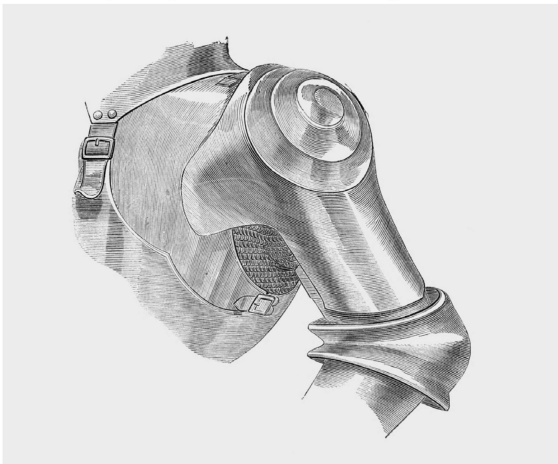

a study of medieval weaponry published just a few years before *Histoire d'un dessinateur*. The volumes were written with the same goal of national regeneration as his didactic children’s novels: “If this last part of our work ... can contribute to impress upon the mind the love of the craft of war,” wrote Viollet-le-Duc in the preface to

f.4 Eugène Emmanuel Viollet-le-Duc. Fifteenth-century spaulders. Woodcut engraving.

volume five, “if it can demonstrate how, after so many unprecedented disasters, France has been able, thanks to patriotism, to erase many of its errors and to recover, we think we will have fulfilled a small part of the task that each Frenchman must carry today.”³⁵

35 *Ibid.*, p. 9.

As always, within Viollet-le-Duc’s historicized outlook, the Middle Ages stand paradoxically as the fantasy reservoir for France’s future. Medieval knights — “these men covered in iron”³⁶ — were models for the “hardened” soldiers of the future. In fact, Viollet-le-Duc transposed the entire modern militarized state onto the Middle Ages: feudal society, thanks to its perpetual state of warfare, had given birth to new iron creatures, just as nineteenth-century industrial Europe was in the process of engendering a new type of mechanized being. Much of Viollet-le-Duc’s

36 Viollet-le-Duc, *Dictionnaire raisonné de l'architecture* (see note 19), vol. 3, p. 164.

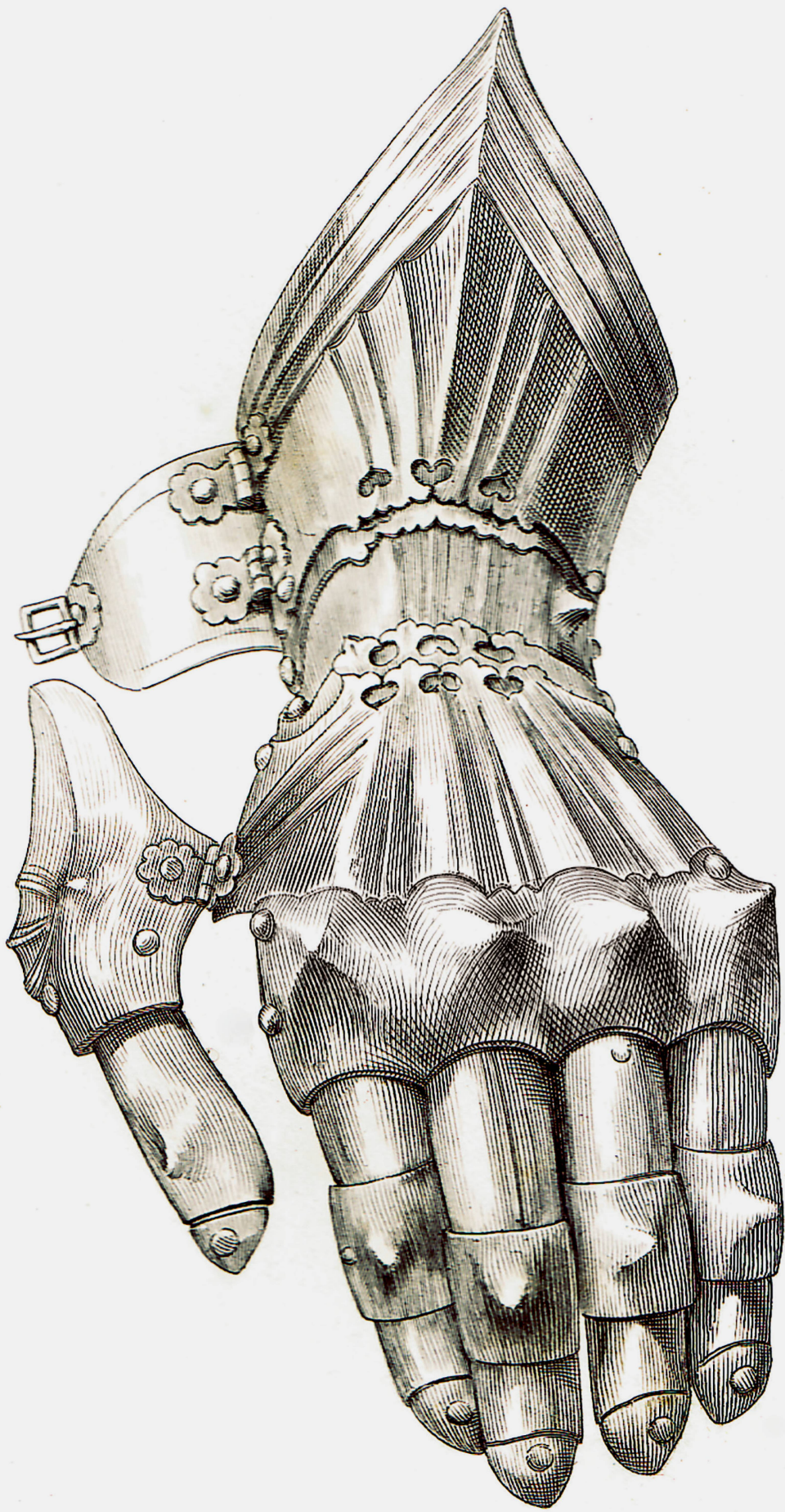

wonderful and manically detailed history of medieval armament centers on the adaptation of body to weapon, weapon to body.

f.4/f.5 Hundreds of fascinating illustrations depict medieval warriors as organisms that “evolve” into a protective shield, speculating that medieval armorers modeled their work on the shells of animals

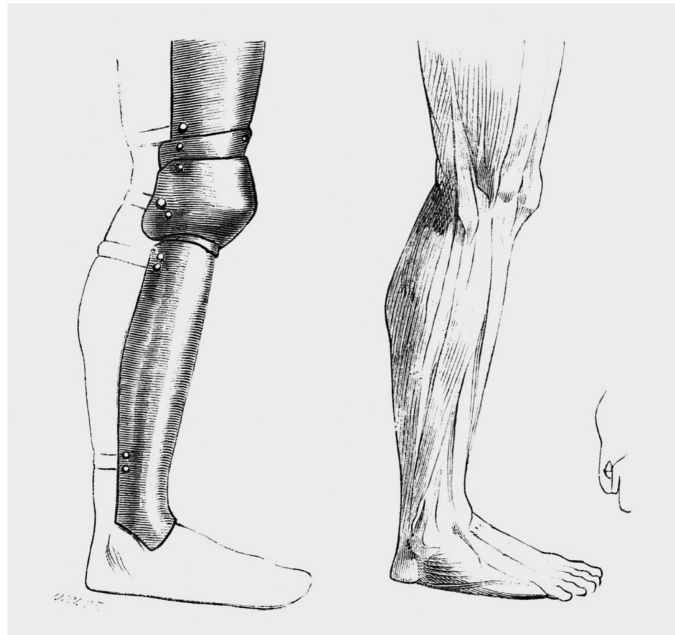

or insects. ³⁷ His essential point is that armor was forged through a very delicate observation of the disposition of the play of muscles and physical movement. ³⁸ Through comparative illustrations he demonstrates how certain parts are adapted to human anatomy ^{f.6} to produce responsive “metallic military clothing,” garments that were all the more astonishing given

“that medieval industrialists didn’t possess the anatomical knowledge so familiar to us today.” He pays attention to the ingenuity and dexterity that allowed the relationship between weapon and organic activity to develop – how Gothic armament had become living machines. He adds, “It is rather strange that our times, which possess such extended knowledge of anatomy, cannot build a defensive clothing appropriate to our body”

³⁹ – a perfect dovetail into the mechanized limb that concluded petit Jean’s anatomy class.

What this last quote shows again is that, according to Viollet-le-Duc, the construction of armament, or any technical invention for that matter, is not so much an “application” of knowledge, as the product of a living process. Authentic invention condenses quasi-spontaneously disparate life circumstances: human needs shaped into the form of an object. It is in this regard, and in this regard only, that they become organic products whereby the boundary between the human and the non-human is eroded. With his study of medieval weaponry, Viollet-le-Duc establishes a filiation for French military tools, in the quasi-biological sense of the term. Showing how they were born out of the behavior of living Frenchmen. That is to say, of actions of the organism at work.

f.5 Eugène Emmanuel. Viollet-le-Duc. Fifteenth-century gauntlet. Steel engraving.

³⁷ Viollet-le-Duc, *Dictionnaire raisonné du mobilier français*, vol. 5 (see note 33), p. 125.

³⁸ *Ibid.*, p. 484.

f.6 Eugène Emmanuel Viollet-le-Duc. Fourteenth-century armored shin-pad compared to the anatomy of the leg. Woodcut engraving.

³⁹ *Ibid.*, pp. 484–5.

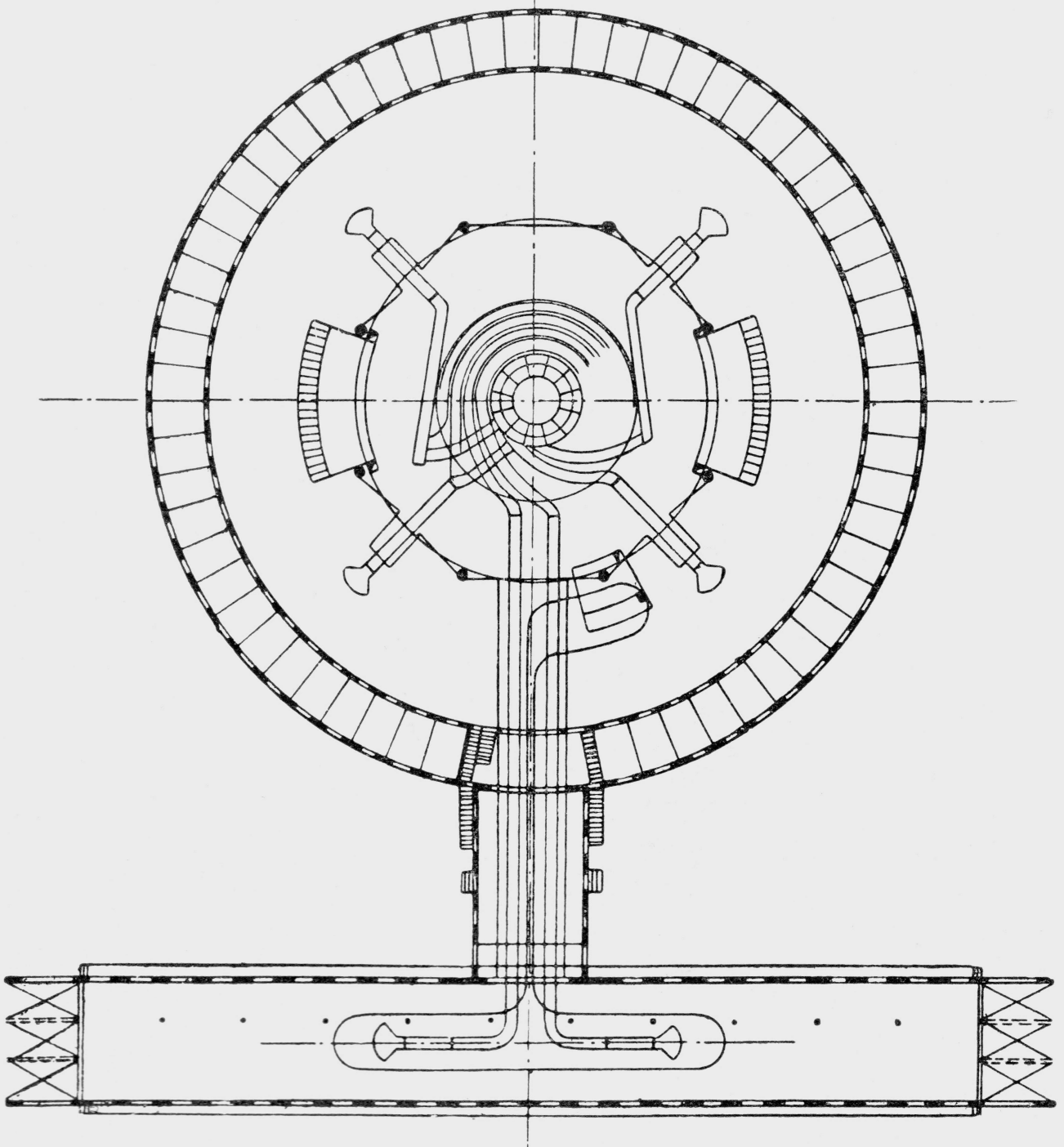

Abb. 13. Grundriß des Paketzustellamts in München.

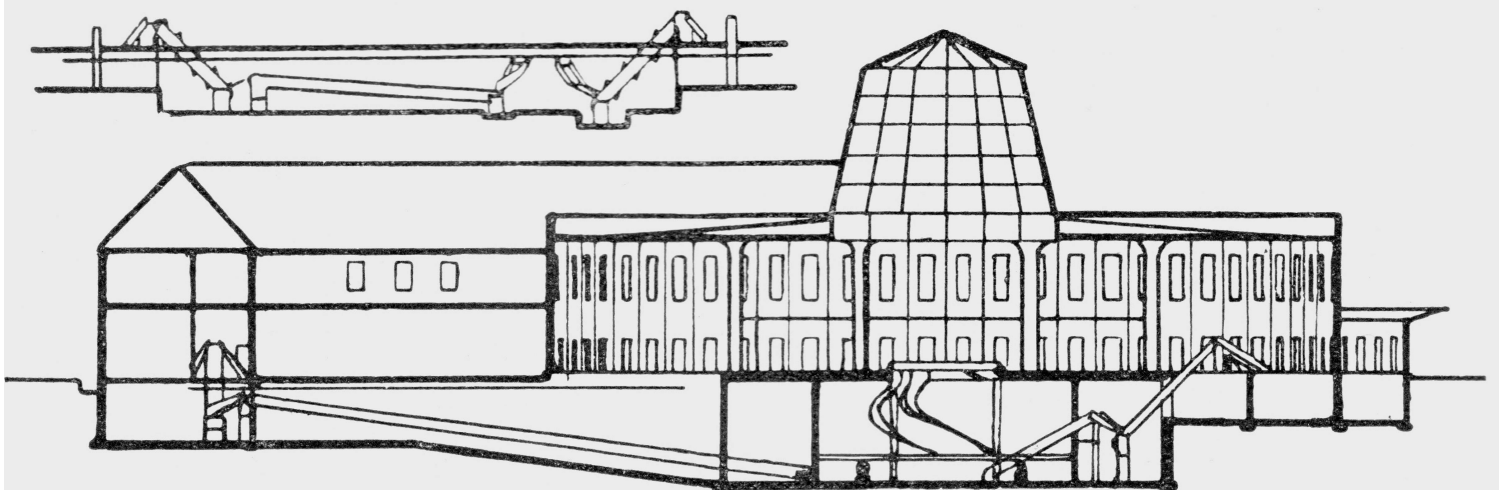

Abb. 14. Aufriß des Paketzustellamts in München.