

Zeitschrift: Schweizer Ingenieur und Architekt
Herausgeber: Verlags-AG der akademischen technischen Vereine
Band: 115 (1997)
Heft: 6

Artikel: Tschumi builds
Autor: Rappaport, Nina
DOI: <https://doi.org/10.5169/seals-79200>

Nutzungsbedingungen

Die ETH-Bibliothek ist die Anbieterin der digitalisierten Zeitschriften. Sie besitzt keine Urheberrechte an den Zeitschriften und ist nicht verantwortlich für deren Inhalte. Die Rechte liegen in der Regel bei den Herausgebern beziehungsweise den externen Rechteinhabern. [Siehe Rechtliche Hinweise.](#)

Conditions d'utilisation

L'ETH Library est le fournisseur des revues numérisées. Elle ne détient aucun droit d'auteur sur les revues et n'est pas responsable de leur contenu. En règle générale, les droits sont détenus par les éditeurs ou les détenteurs de droits externes. [Voir Informations légales.](#)

Terms of use

The ETH Library is the provider of the digitised journals. It does not own any copyrights to the journals and is not responsible for their content. The rights usually lie with the publishers or the external rights holders. [See Legal notice.](#)

Download PDF: 30.01.2025

ETH-Bibliothek Zürich, E-Periodica, <https://www.e-periodica.ch>

Nina Rappaport, New York

Tschumi Builds

Bernard Tschumi, architect and Dean of the Graduate School of Architecture Planning and Preservation at Columbia University, New York, has more projects under construction than ever before. Known for his design of Parc de la Villette in Paris (1982–1995), he was recently awarded the «1996 Grand Prix National d'Architecture» from the French Ministry of Culture. He also received two 1996 awards from the American Institute of Architects New York Chapter for the design of the Paris Architecture School and Le Fresnoy.

Bernard Tschumi discusses his current buildings in a November 1996 interview in his open loft office space in Chelsea Manhattan. The lights are dimmed to keep the glare off the computers for the young architects, huge computer drawings hang on walls, and a computer graveyard sits on one side of the office, the result of the latest upgrade.

Projects in Europe

Since you are half Swiss, born in Lausanne, your father was an engineer practicing in Lausanne, and you attended ETH, it is interesting that you are working on a project in Lausanne.

Yes, in 1994 I won the competition for the Lausanne train station area. The Interface Railway Station and Bridge, a \$30 million project for the future master plan for the urbanization of the industrial valley which should begin construction in 1998, so we are currently working on final designs. Lausanne is interesting to me because it is a three dimensional city, with multilevels, since it is built on a hillside. The function of the new bridge connection is not only horizontal but to cross from below to above and link all the levels of the buildings and the city.

You are also working on two buildings in France where you became recognized after you designed Parc de la Villette. Both are educational institutions and both were invited competitions. Le Fresnoy National Center for Contemporary Arts in Tourcoing near Lille, a competition which you won in 1991, is a

110,000 square foot complex costing \$25 million. The Center which combines education in visual arts, sound, TV, and media arts as an «Electronic Bauhaus», similar to the Karlsruhe Zentrum für Media und Technologie, will have the most advanced production studios. It has been published and exhibited widely but now it is becoming reality with completion slated for Spring 1997. The existing building had been a 1920s entertainment complex with cinema, dance halls and horseback riding which had severely dilapidated. What are the most fascinating aspects about the new design?

The largest building is 100×100 meters and was in a state of ruin with a rotten roof and unsafe conditions. All the other competition entries wanted to tear down the buildings. But I felt that the old spaces were extraordinary, so why not leave them underneath: We created a huge roof that forms the support for the building and an umbrella over the old roof. The duct work, stage mechanisms and mechanical systems will be suspended from the roof in an in-between space, between the old and the new.

How do you feel about restoration of historic buildings?

It depends on how and where, but at Le Fresnoy, you wouldn't be able to build interior spaces like this today. I would rather keep the old and then add the new to it. The new roof supports the old building below so that there is a play between the new and the old.

What is your concept of the box within the box?

The boxes of the old buildings are under the new roof which is visible in the exploded axonometric drawing; the new building is a box in a box. We are leaving the existing untouched so it will unfold like a Russian Doll.

Is this similar to domes of cathedrals or La Scala in Milan which have spaces between the superficial structure and the interior structure?

Yes, or the space in Grand Central Station, between the two skins. It is the space not designed for the public, but happened spaces.

How is this in-between area to be used?

Between the two roofs the residual area can be used for exhibitions and film viewing. It becomes a real space. Students can sit on benches suspended from the roof. The in-between area is a landscape of its own. It has a stage set quality with ramps and catwalks and spiral metal stairs. Or it can be compared to a backstage which is then what it can become, the stage itself. You can wind around the ramps on top of the old buildings to a roof garden terrace and elevators. The metal roof is cut with a number of semi-elliptical openings and covered with glass to allow light to penetrate.

What are the street elevations like where the original building was partially demolished to accommodate the new offices?

The corrugated metal roof folds and becomes the back facade, which is fairly enclosed on the north side because of the noise from the highway. Still under the roof, but on the south side, we wanted to provide a transparent image to the main entrance facade. The roof is 90 feet high and has an amazing scale in relationship to the two-story office spaces and their curtain wall.

How does your view of circulation differ from the Modernists?

Their view of circulation only dealt with routes and vectors. In this particular case the main difference is activities. One other example is the competition proposal which we submitted for the Library of France, where we had the running track going through the library. In other words complete interferences, a transgression of one program by the other. Modern movement architects would keep those things separate. I try through the movement pattern to activate a program, or transform a program. As in Fresnoy, the contamination of different programs, the idea of cross over of programs from one area to another. But it is also pedagogical, they want the different disciplines to merge and the architecture helps that. The Bauhaus was not doing that, it had separated departments.

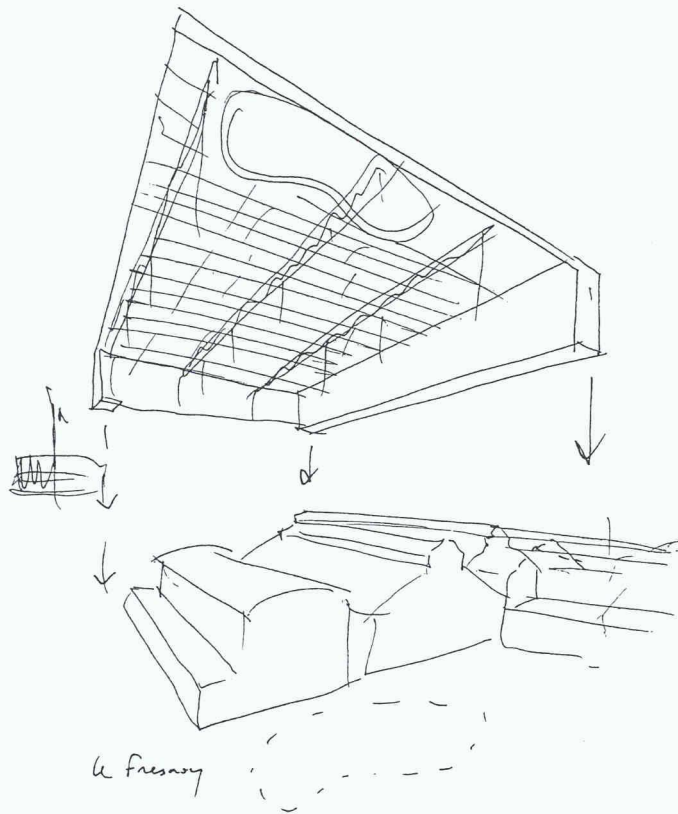

Le Fresnoy, Tourcoing, France. Bernard Tschumi Architects, New York
(Plans/Slide: Bernard Tschumi Architects, NY)

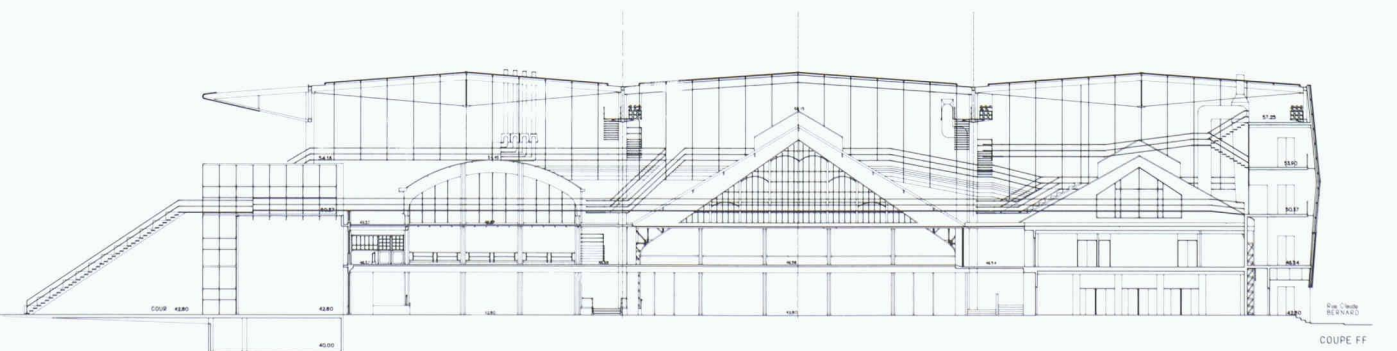
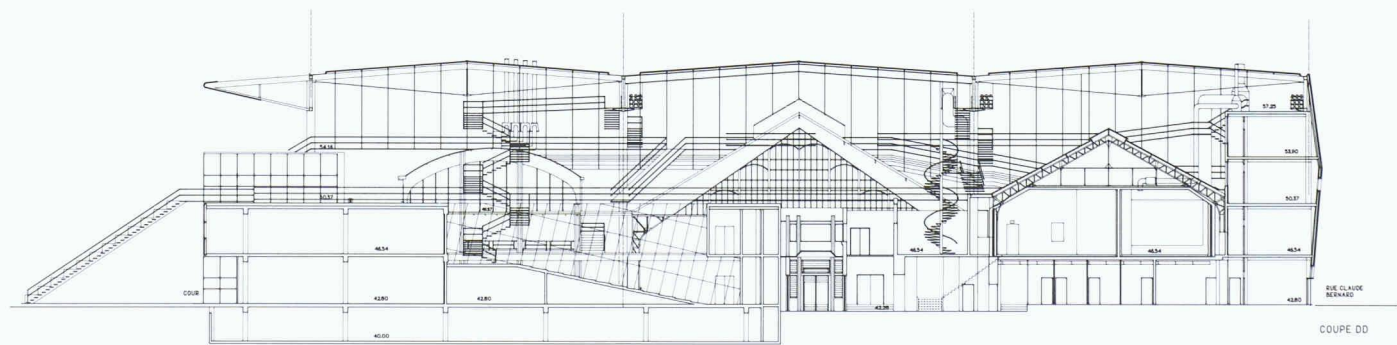
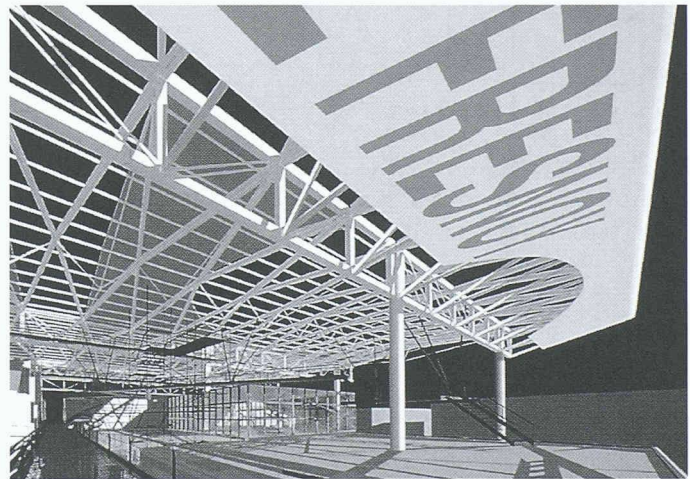

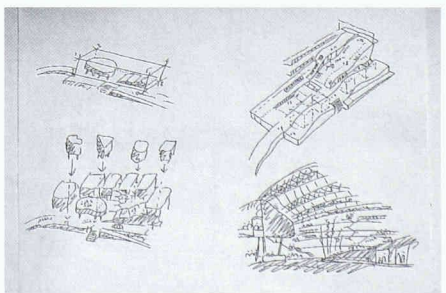
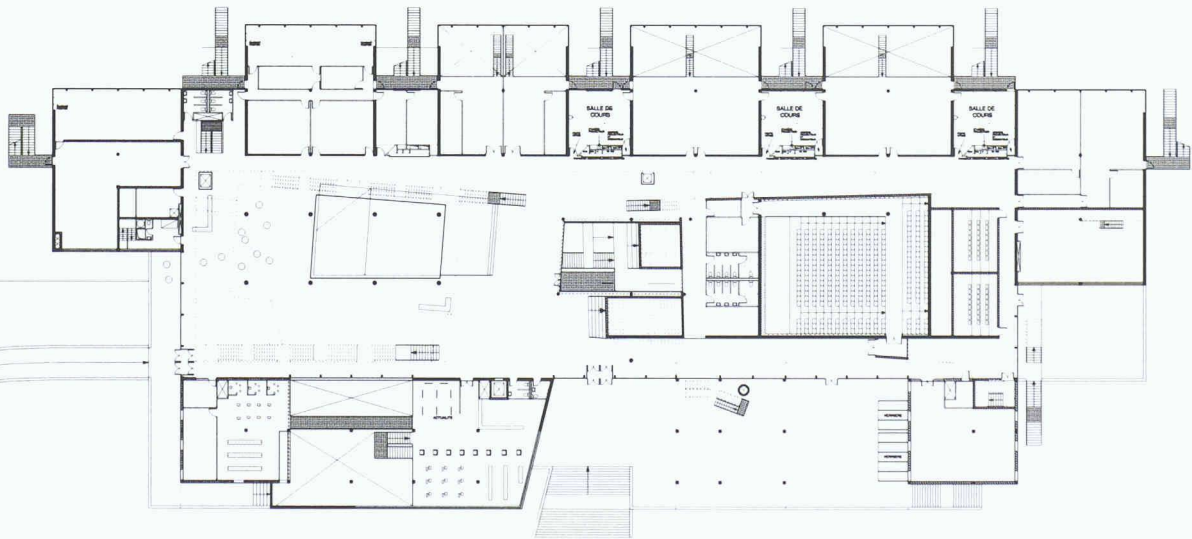
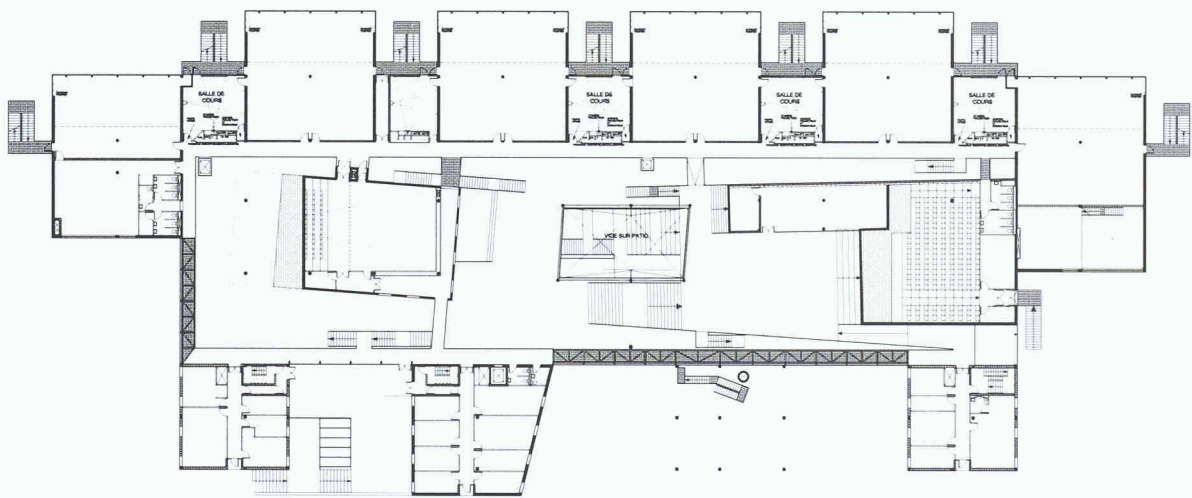
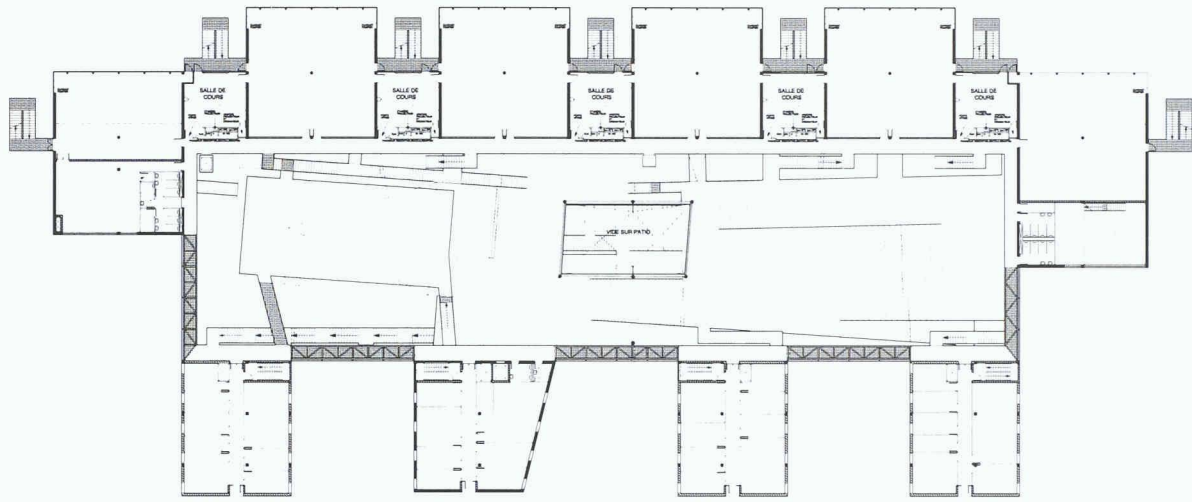

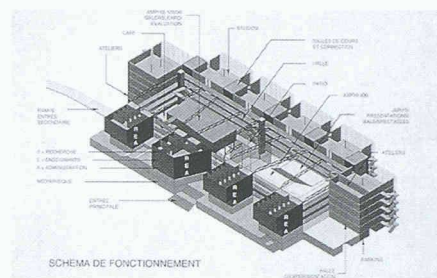
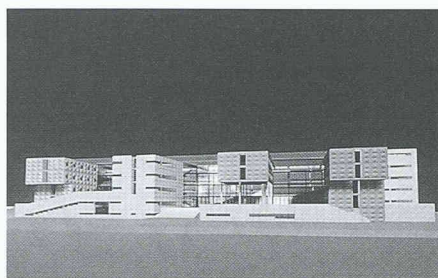

Ecole d'Architecture, Marne la Vallée, France.
Bernard Tschumi Architects, New York
(Plans/Slides: Bernard Tschumi Architects, NY)

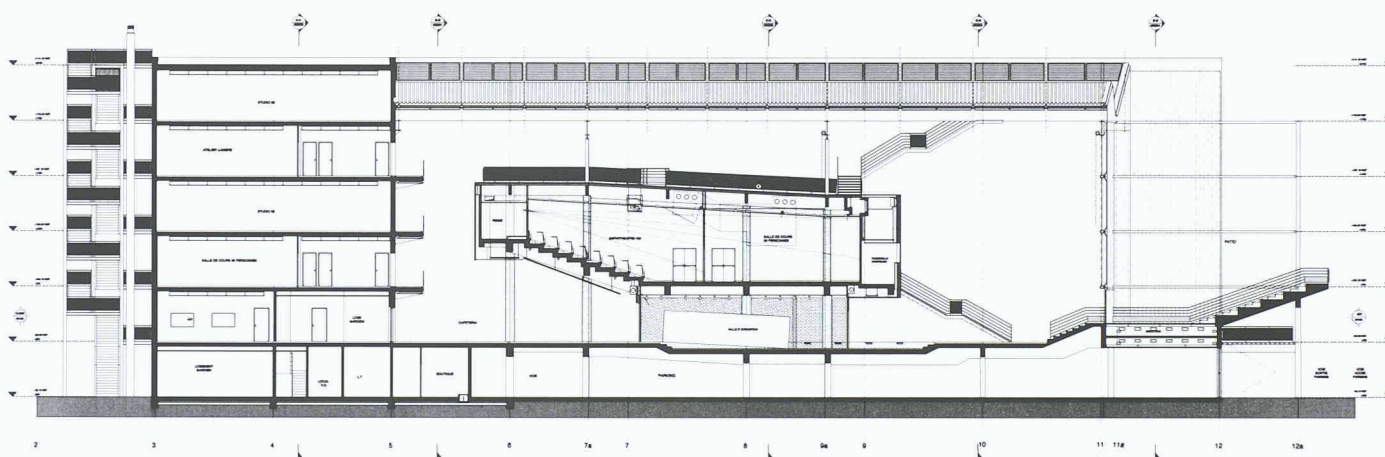

Your second project won through a limited competition in France is for the new Ecole d'Architecture at Champs-sur-Marne in Marne la Vallée. The school, to be build out side of Paris - near Euro Disney - is at a scientific and technical campus similar to ETH in Zurich. The \$30 million 275,000 square foot project for 1200 architecture students will begin construction in the fall of 1997. How did you approach this project which really did not have a well-defined program?

I said, let's do it as we think a school should be. I know almost too much about the topic, being Dean at Columbia. So we did a survey of other schools like Yale by Rudolph and Cincinnati by Eisenman, which are over designed. So the design was to make the building as neutral as possible for the age of mobility and the modem.

Although you are not involved with the program, the curriculum or the politics of the school, how does your design with its ramps and walkways, three auditoriums, library research areas, offices, multimedia facilities and cafeterias influence the educational activities in the building?

First of all I designed something which is

very un-French: You can see inside the studios as you walk past on the walkways; like a show window of what is happening in the school. Everybody sees what everybody else is doing. For me that is important because the French have the tendency to hide themselves - this will encourage debate. There will be blocks of double-height studios with seminar rooms in-between to encourage debate between design projects and history/theory. It is to be north facing for diffused light all opening out onto a main central space. Instead of one classroom area they alternate with the studios so that the interrelation will happen. That is my way to change the curriculum a little bit.

How does your concept of movement as a generator of space and events manifest itself in this project?

To me the most important things in schools don't happen in the classrooms or the studios, they happen in the stairs and the gathering spaces. All the official activities look towards the 25x100 meter semi-public un-programmed space, which is like an indoor public square. The students can take it over and do what they need to with it, whether it be exhibitions

or parties. This is the in-between space of sorts, a totally common space and common denominator of design. My view is that if there is such a place to take over, what ever the educational system, the students will be able to transcend it.

What are the materials and some significant design elements in the school?

First the main void containing the café, the exhibit spaces, the two public auditoriums is enclosed by the studios and by the research and administration offices. These are made of pressed aluminum panels and are located over the library which is poured concrete (béton brut). The studios have a glass skin, somehow I am sure people will say, saying hello to Gropius and Dessau. The library will be crossed with ramps and stairs for students to sit on and work on, that are both protected and isolated. The skin of the auditorium is expanded metal, namely, the metal forms waved, partially opened strips so that light doesn't totally penetrate the space: The box will not be fully opaque. You can see a red wall through it like a ghost, so that it has a mysterious effect.



Lerner Student Center, Columbia University, New York. Bernard Tschumi Architects, New York (Slides: Bernard Tschumi Architects, NY)

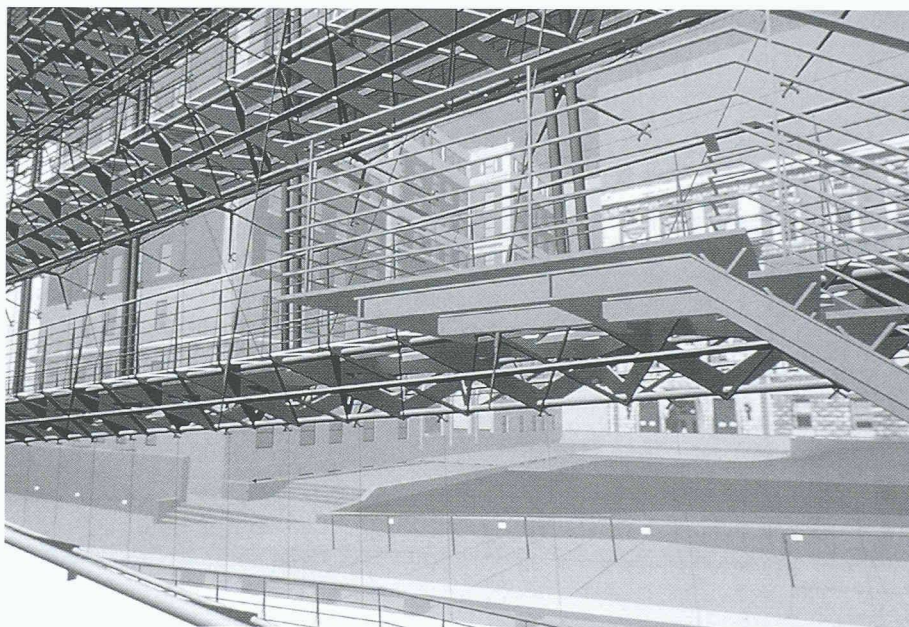

First project in the U.S.

Now you are working on your first major project in the U.S., the Alfred J. Lerner Student Center at Columbia University in association with Gruzen Samton Architects, which replaces a smaller student center from the 1960s. Your new 220,000 square foot building costing \$68 million began construction in the fall and will be completed in 1999. The eight-story Broadway wing of the building will house the bookstore, game rooms, computer center, meeting rooms, administrative offices and a 500-seat cinema. The four story wing facing Butler Library will include a 24 hour entrance, a basement night club called the Plex, dining hall, café and meeting rooms. In the center there will be a glass atrium space, facing campus, called The Hub - the main circulation area, from which one will be able to view the activities in the building with pedestrian ramps linking the two wings of the building. This project has many interesting design and construction issues - but first, what is your attitude towards the historic plan of the university?

This is a real challenge to create a new building within the McKim Mead & White plan. In a way like the Carpenter Center by Le Corbusier which is on the historic Harvard Campus, against the original fa-

bric. I am not a contextualist, however, we will continue the McKim plan, but with a reinterpretation. The plan originally had a second row of buildings, Avery Hall was the only one completed. So part of the new building will continue that idea. We are following the solid-void-solid rhythm as a starting point. The elevation on the Broadway side will have a brick facade with a brick and granite base similar to the adjacent McKim buildings making the new building quiet on the outside and more dynamic on the inside. The part of the building facing campus will be lower rise also because the land changes height, so it won't compete with the adjacent historic Butler Library. The Broadway side is half a story higher, in order to create a continuity we will use ramps, rather than the discontinuity of stairs.

What are some of the technological innovations in the project?

I am having good experience building at Columbia, which is relatively conservative. The ramps will be glass, so that you are walking on glass, and glass will support the facade. This type of structural glazing will be the first to be used in New York. We took the University trustees to Paris to

see projects which used this glazing so that they could understand the concept. Engineer Hugh Dutton, of London, is working with us on this project as well as the Paris School of Architecture.

If the two wings, one towards campus and the other towards Broadway, are relatively contextual, I tried to push the limits on the ramps in-between. Columbia was supportive and they were scared and cautious, and rightly so. But then we went far because the relationship in the coordination between the glass and steel was very unusual. In New York they are different unions, and glass usually never supports anything - but just put up within mullions - so we had to develop that and it became a fantastic experiment and we were able to push it very far including the glass floor on the ramps.

Theoretical and practical aspects

How does your theoretical work translate into the practice of building?

I stopped drawing for 10 years in 1968 after the protests in Paris and I developed questions and conceptual diagrams. One constant throughout all these years is move-

ment; architecture is space, movement and event and of course their relationship. The notion of place as the space of movement and that is where events occur. That is the starting point.

How has your attitude towards architecture and design changed in both your theoretical work and practice, now that you are building more?

On the one hand they haven't changed at all. I am doing exactly what I set myself to try to do. On the other hand, building, constructing and dealing with the construction industry introduces a new dimension that probably will need one day to be theorized.

Why hasn't your attitude changed that much?

My early work had one obsession, that architecture was something to be seen as dynamic - not a static building, but a building seen with the activities to take place within it and the movement of bodies that go through the building. There are three elements: space / movement / event. When I was doing the Manhattan Transcripts in 1981, there were systems of notation where I would show photographs of the action with arrows and vectors showing movement of the bodies in space. I was very interested in this notion of the movement as one of the possible generators for architectural space.

In projects that are being built at the moment, like Le Fresnoy or the Columbia Student Center, the role of those vectors of movement is absolutely crucial and in many ways the relation of those vectors and movement with the overall space and what I call the in-between, the free space between the functional constraints, always finds its origin in the early theoretical work.

What then has changed in your work and ideas?

The logic of drawing when I was doing pen on paper was 2-D and dealt with the sense of time and filming - it was dematerialized. I have always said that architecture is the materialization of a concept. Of course when you materialize it, it is not the same if you do it with steel or with sheet rock. And here has been the great fascination of learning. Because I knew certain things: I like working with structural engineers, I like working with people who develop new capabilities with materials and therefore I also would like to push a concept in a new constructive and inven-

tive manner. In other words, when ever there is a place of a concept - in the Columbia project is the place of the ramps, in La Villette it was the place with the galleries and bridges - then I try to work with the best engineers so that the place of the concept is the place of technological invention. This comes almost every time with a project: whenever it is a straight forward architecture, it is straight forward engineering, whenever we are pushing the limits conceptually, we are using new engineering with structural glass or using new ways of attaching steel members.

Is that conscious?

Funnily enough, at first you don't think of it, then you realize that, again I am going in this direction, so yes, it is in a sense very conscious. I find that fascinating because the dimension of the construction was one that was not integrated in my early work. For example, at Columbia it has been very hard to find the contractors who can do it. We went through a set of interviews. Now we have selected Eiffel from France who will do it, but we had to go as far across the Atlantic to find someone, so this is part of the endeavor.

As Dean of Columbia University's architecture program since 1988 what do you see as important today in the teaching of architecture to the next generation of architects?

There are two things, one which is not difficult to do in NYC: I want our students to be aware of contemporary culture in which they live. Architecture is always in the making and always being reinvented, so I want the students to be aware of what is happening in music and film and thinking, from physics to math.

Then the other concept turns back to the issue of construction, that we have really developed in the last few years. Besides that I have brought philosophers and thinkers into the school, simultaneously we have developed our construction building technology programs. With a remarkable professor, Anthony Webster, he has been able to bring people from Ove Arup to Santiago Calatrava to the students, so that there is a very serious discussion on how things are built. My great criticism is that students think that everything can be done with sheet rock, and it becomes a totally gratuitous game, and now they are starting to understand how the forces work. Now my concern as a building architect is, how do you deal with the construction industry which is awfully conservative in New York compared to elsewhere, even in other parts of the US.

Your work was an example in the Light Construction show at MOMA in 1995, how does your work in deconstruction fit in with that of the new technologies of light construction?

It is hard to put one against the other, except that you could say that deconstruction without any doubt, found its origin in literary theory. It was something that had to do with language, while light construction started with materials, that are lighter, that are translucent. One is based on the world of ideas and the other materials - that they meet is nice.

What are you reading now and what philosophers are of interest to you today?

I still read very much of the same writers and analysts, some like Paul Virilio, who is more a popular writer and touches on issues which I find are quite interesting. The question is that there has been entire departments at American universities who sort of take the work of French post-structuralists as a bible. One wants to be careful not to make anybody think that there is a cause and effect relationship between the writing of a philosopher and the architecture of an architect. They proceed so differently. But we are all part of the same culture.

Does deconstruction still relate to your current projects?

Real deconstruction yes, the stylistic and journalistic definition no, that was superficial. And in reality the only thing I could give a definition to deconstruction that is of any interest, is that it questioned the idea of synthesis of globality, of unity and talks about multiple layers. The work I do works on different logic and independent layers but it doesn't have to take a form of obvious things that look a sort of constructivist. The game which had been played between the word deconstruction and constructivism was, I always thought, a journalistic game.

Does deconstructivism have relevance in architecture today?

I don't think it has a hand, except that people would associate you with that mode of thinking versus post-modernist. In reality, at the time, it was important because you had the historians on the one hand and the contemporary on the other hand, and of course, I like being on the side of the contemporary.

Address of the author:

Nina Rappaport, art historian, New York City