

**Zeitschrift:** Schweizerische Polytechnische Zeitschrift  
**Band:** 2 (1857)  
**Heft:** 2  
  
**Anhang:** Tafeln

### **Nutzungsbedingungen**

Die ETH-Bibliothek ist die Anbieterin der digitalisierten Zeitschriften. Sie besitzt keine Urheberrechte an den Zeitschriften und ist nicht verantwortlich für deren Inhalte. Die Rechte liegen in der Regel bei den Herausgebern beziehungsweise den externen Rechteinhabern. [Siehe Rechtliche Hinweise.](#)

### **Conditions d'utilisation**

L'ETH Library est le fournisseur des revues numérisées. Elle ne détient aucun droit d'auteur sur les revues et n'est pas responsable de leur contenu. En règle générale, les droits sont détenus par les éditeurs ou les détenteurs de droits externes. [Voir Informations légales.](#)

### **Terms of use**

The ETH Library is the provider of the digitised journals. It does not own any copyrights to the journals and is not responsible for their content. The rights usually lie with the publishers or the external rights holders. [See Legal notice.](#)

**Download PDF:** 02.03.2025

**ETH-Bibliothek Zürich, E-Periodica, <https://www.e-periodica.ch>**

Reuleaux-Festigkeit der Federn.

Schweiz. polytechn. Zeitschrift.

Band II. Taf. 4.

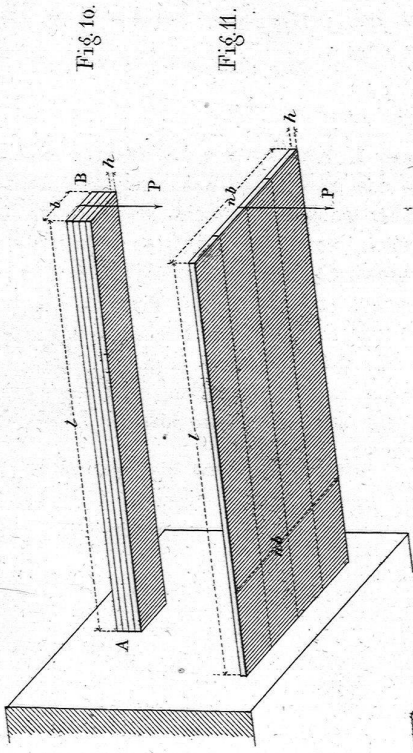

Fig. 10.

Fig. 11.

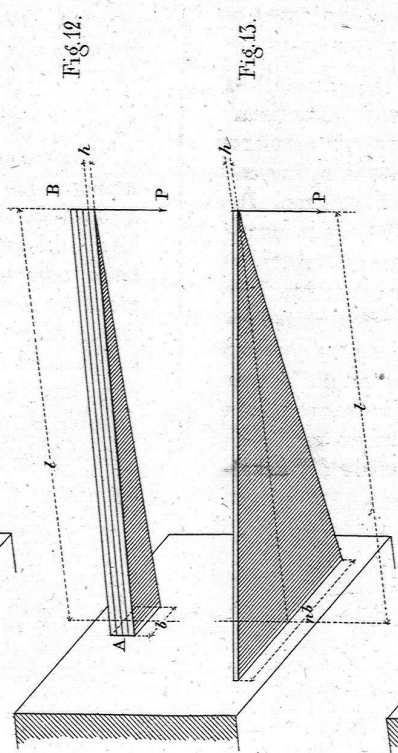

Fig. 12.

Fig. 13.

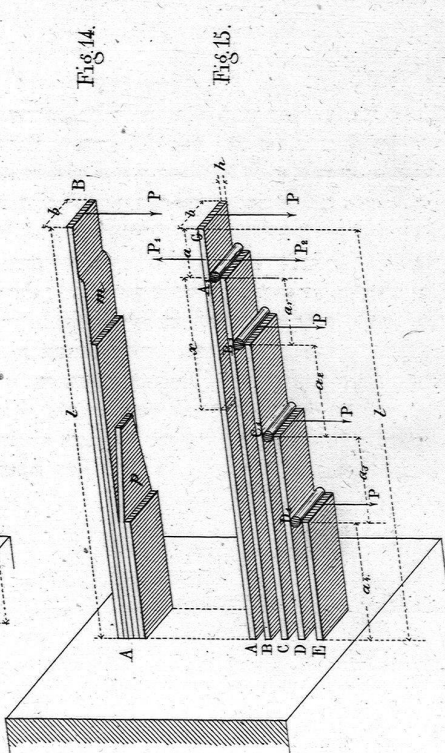

Fig. 14.

Fig. 15.

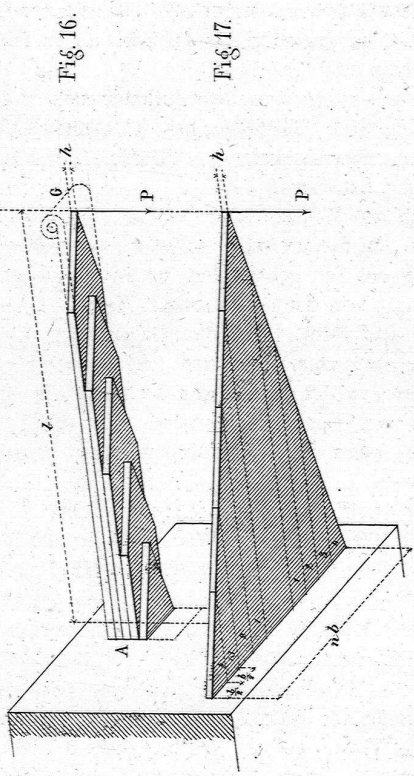

Fig. 16.

Fig. 17.

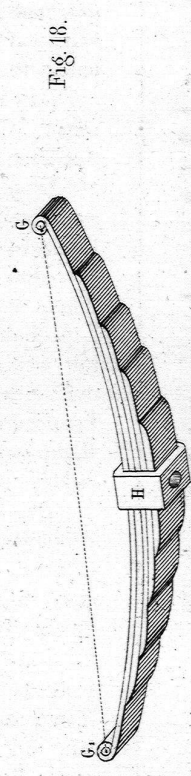

Fig. 18.

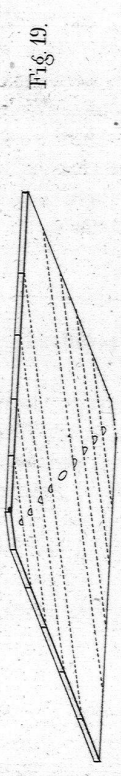

Fig. 19.

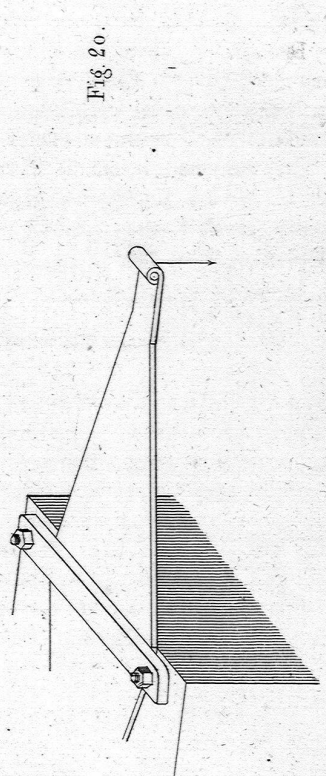
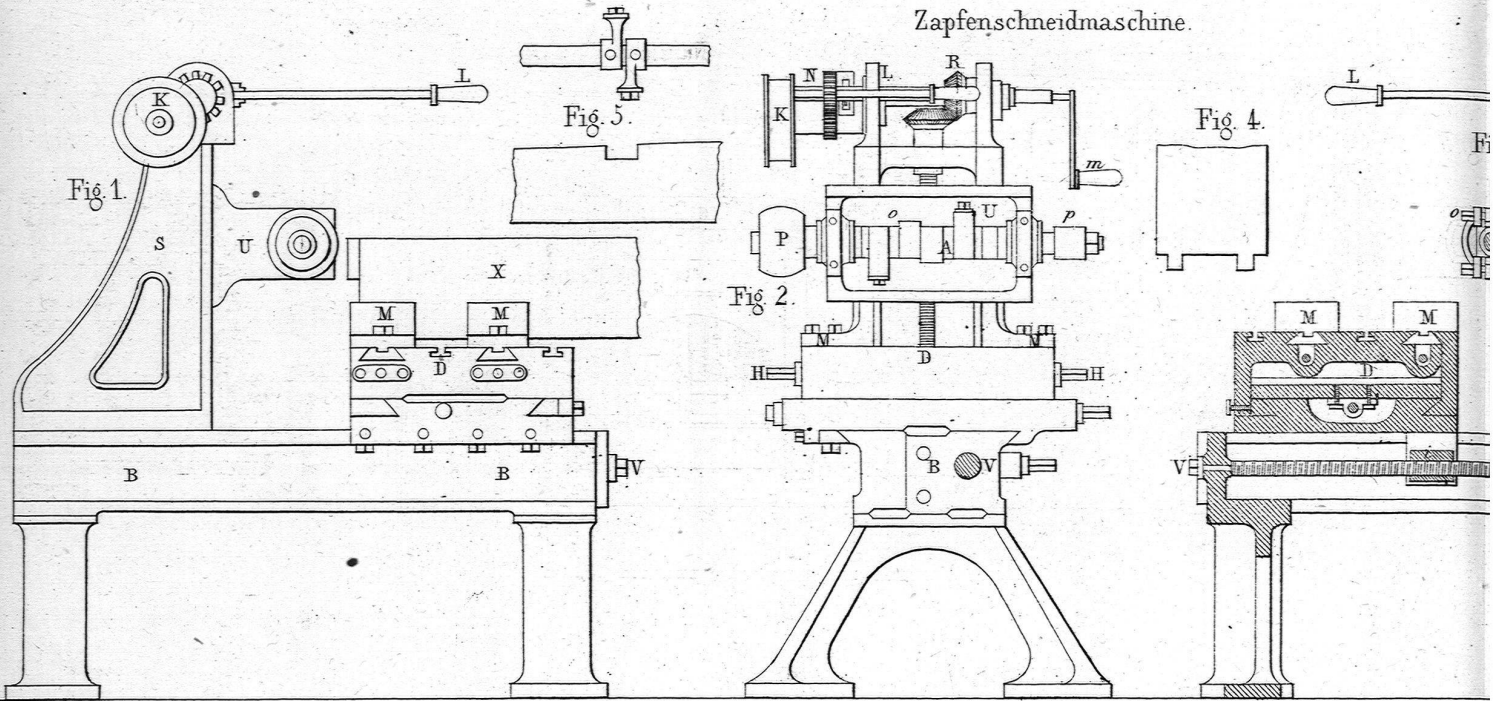
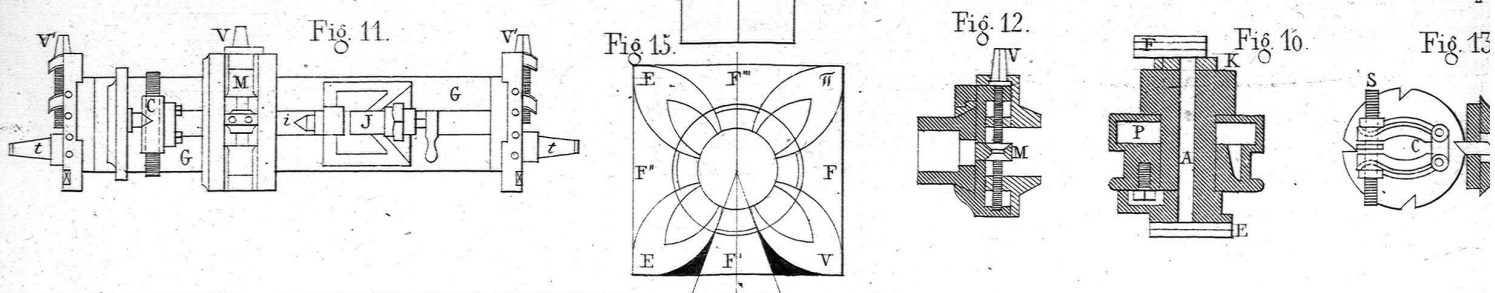
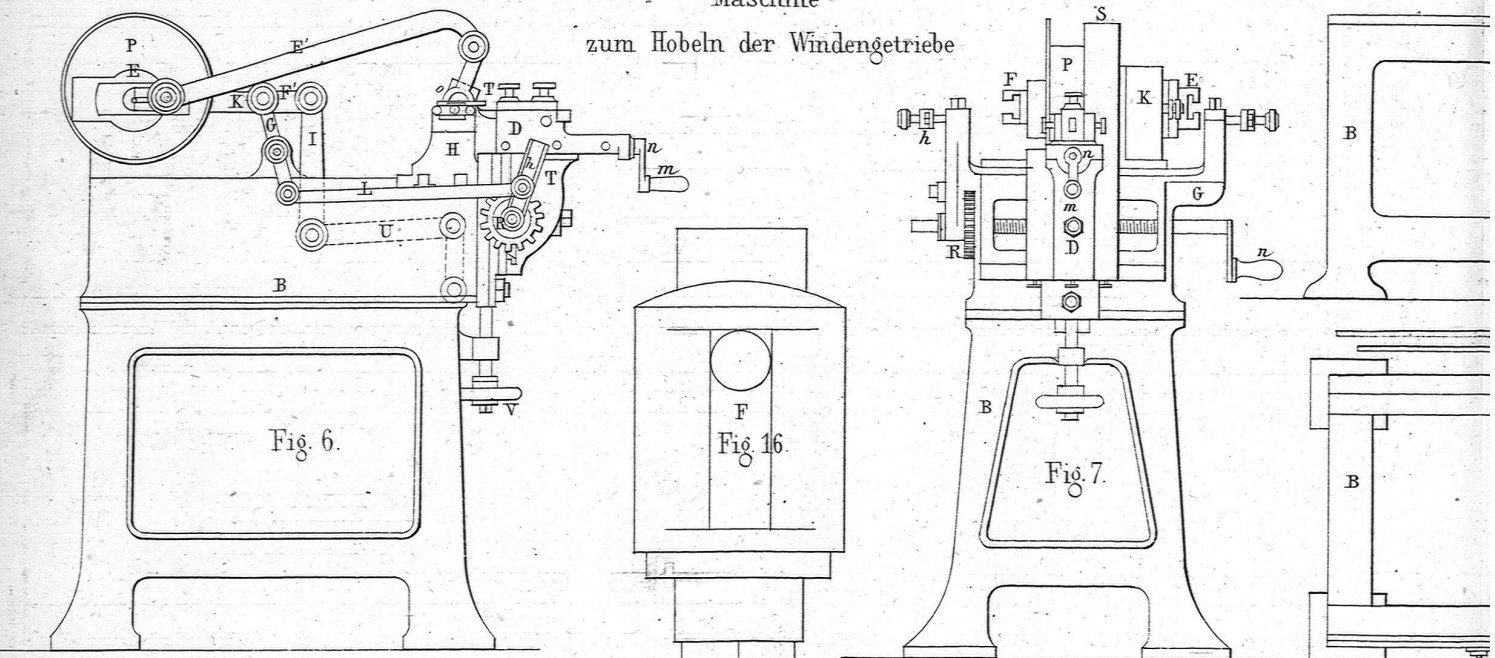

Fig. 20.

Zapfenschneidmaschine.



Maschine zum Hobeln der Windengetriebe



Nuthschneidmaschine.

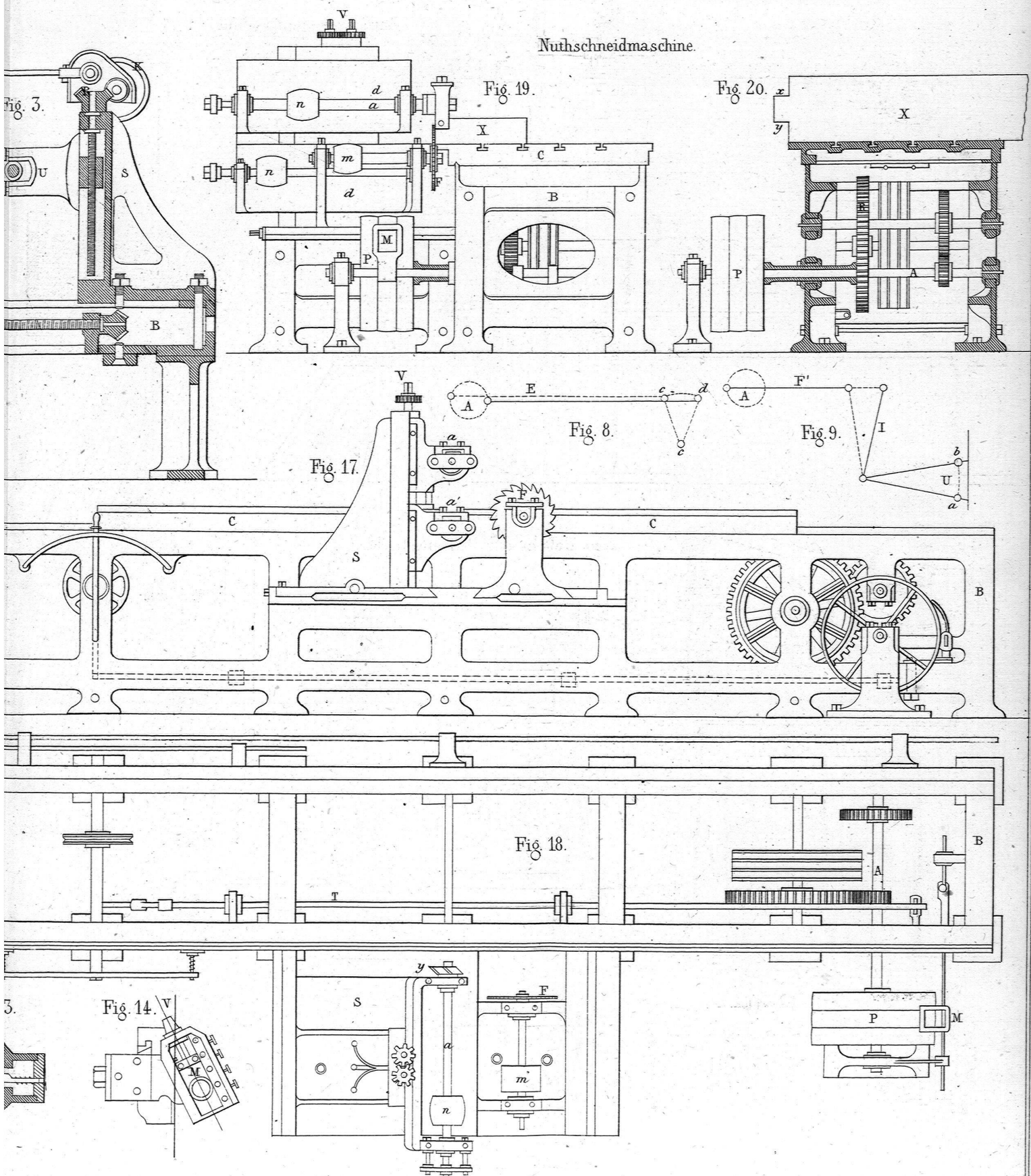

Kohlensäure Dampfmaschine. Von Ghilliano & Crispin.

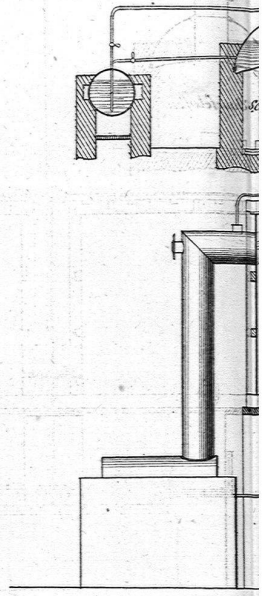
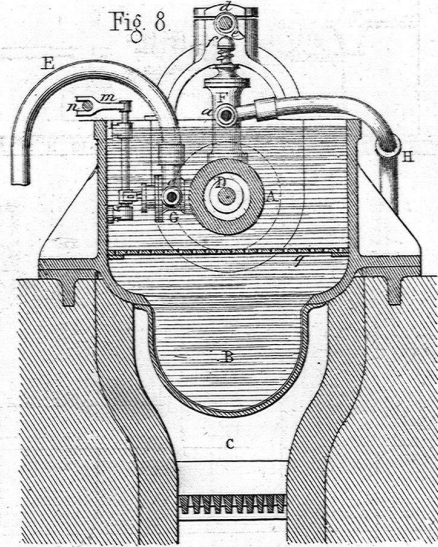
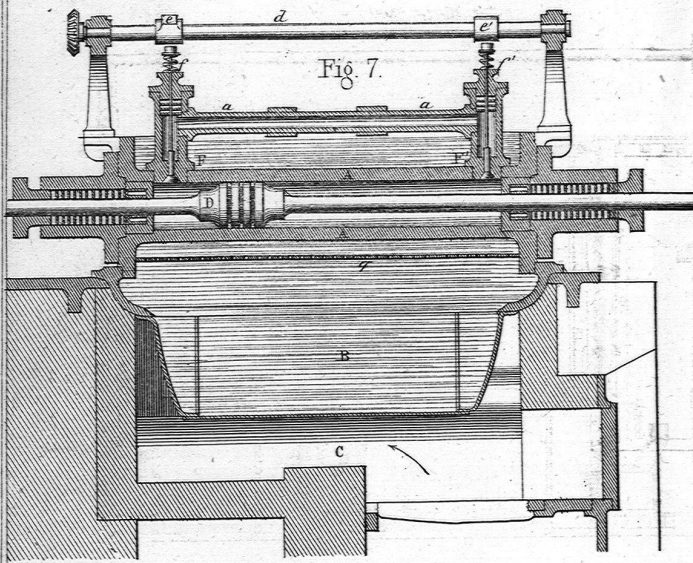

Regulator für Kraftmaschinen. Von Moison.

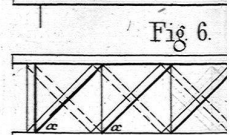
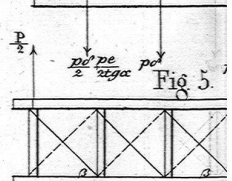
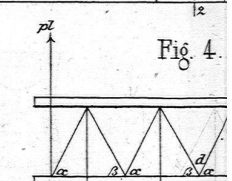
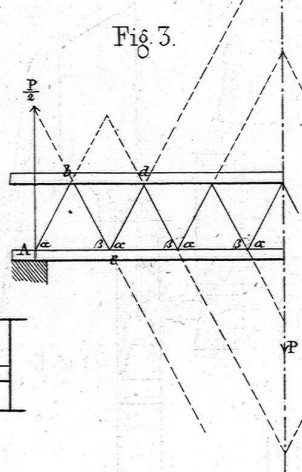
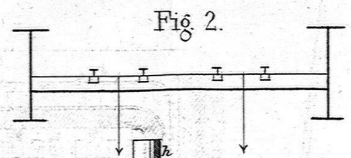
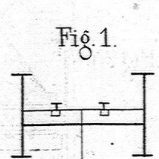
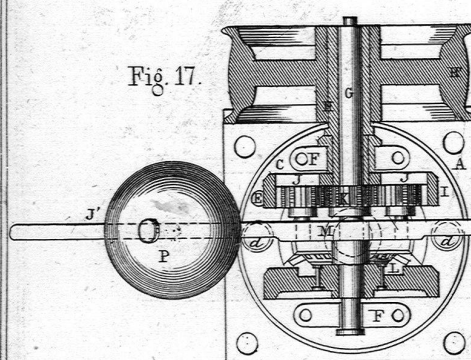
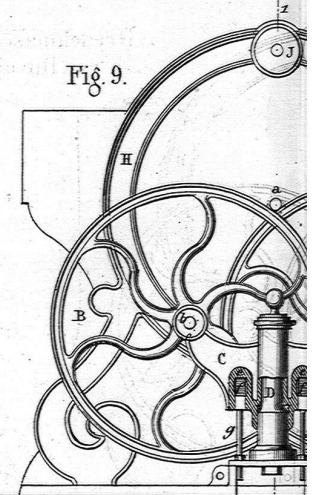
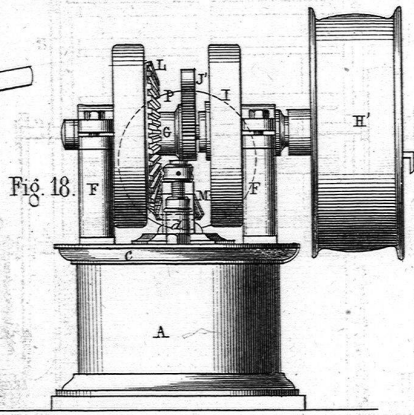
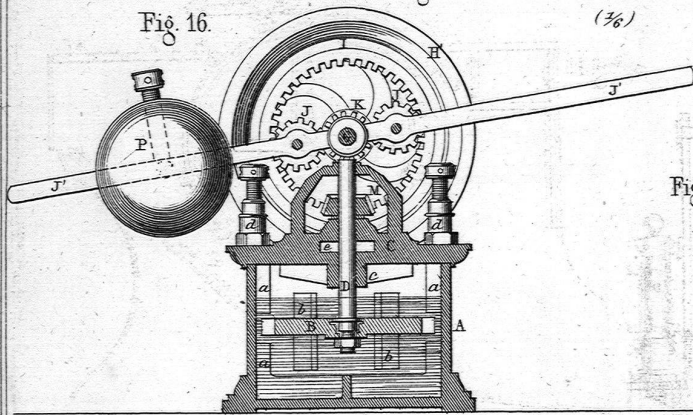
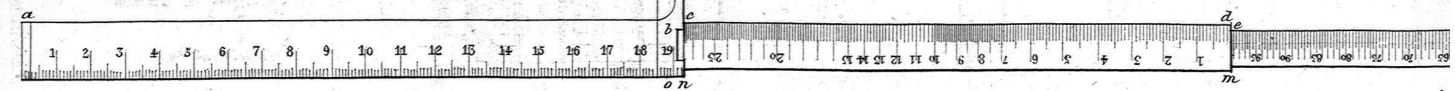
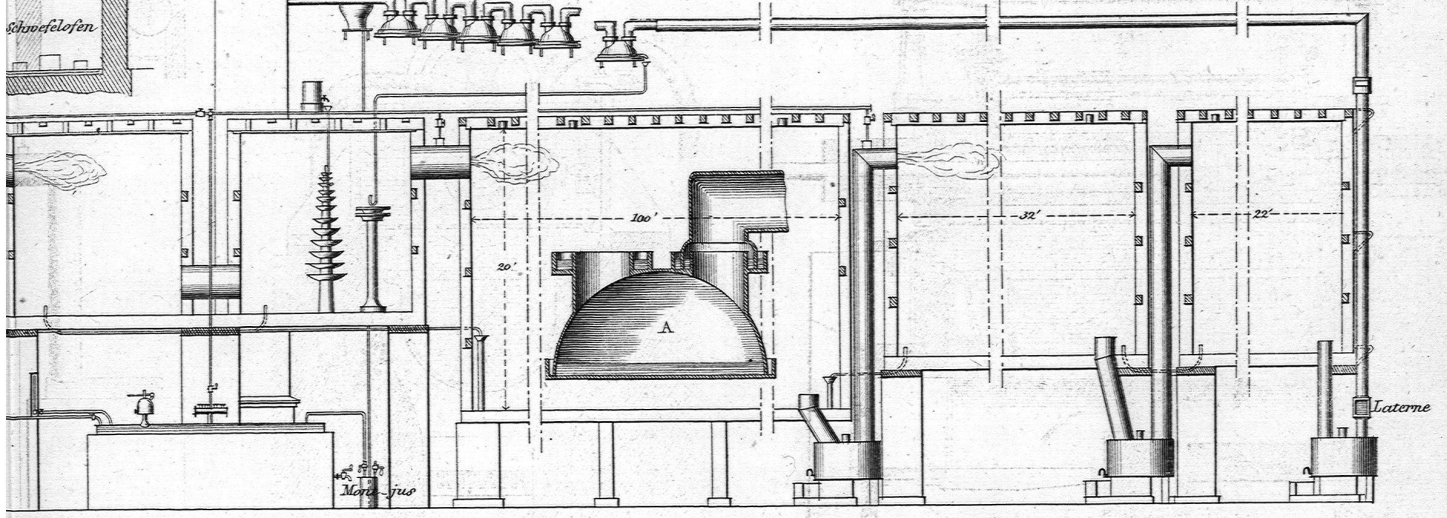

Fig. 19.



Kunheims Schwefelsäure-Fabrikation (Maßstab  $\frac{1}{100}$  Maße in Preuss. Fuß) (zu Seite 20)



Dreschmaschine von Duvoir.

Maßstab  $\frac{1}{15}$

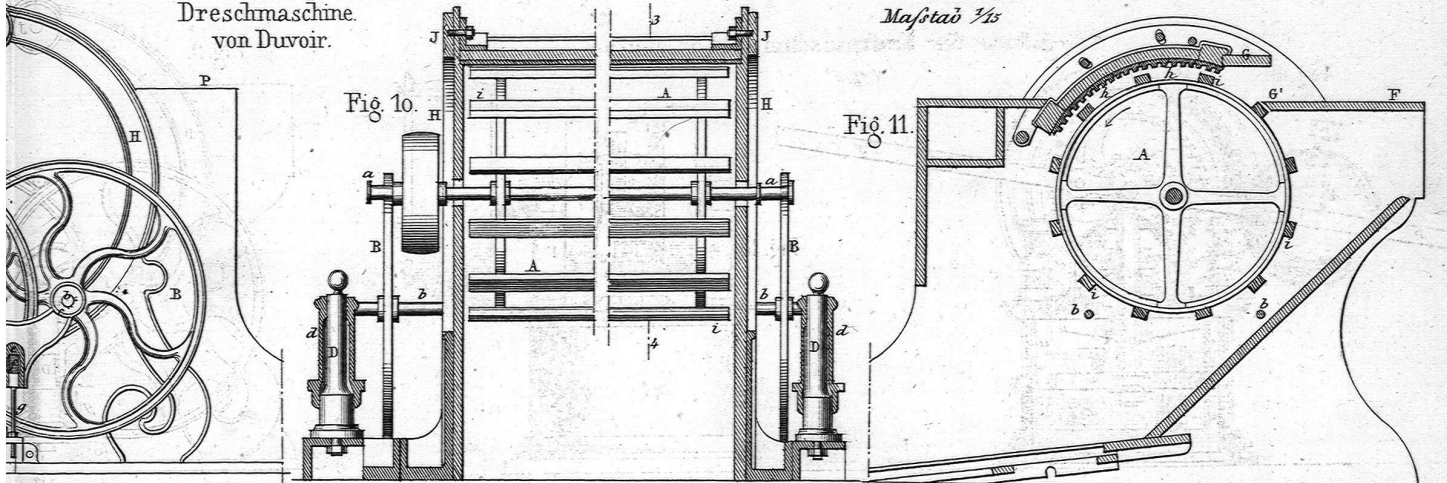

Fig. 12.

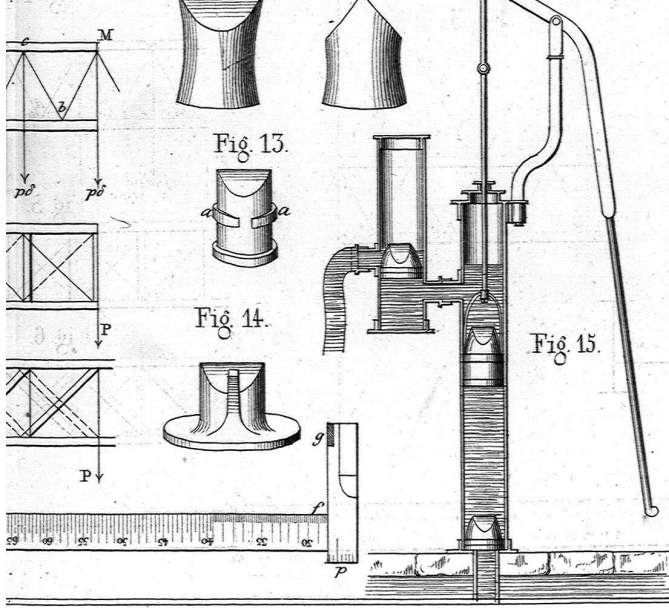

Fig. 20.

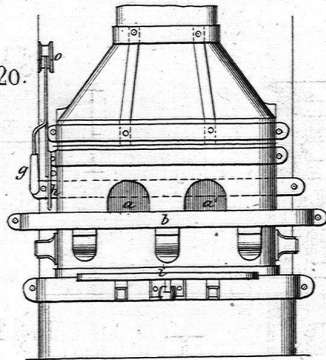

Fig. 21.

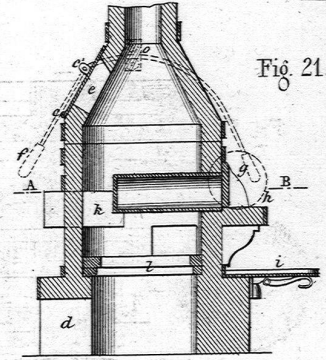
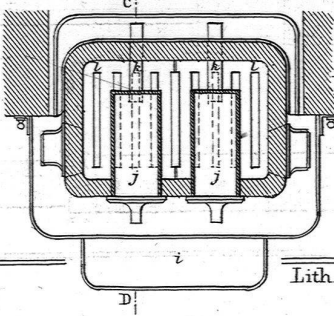
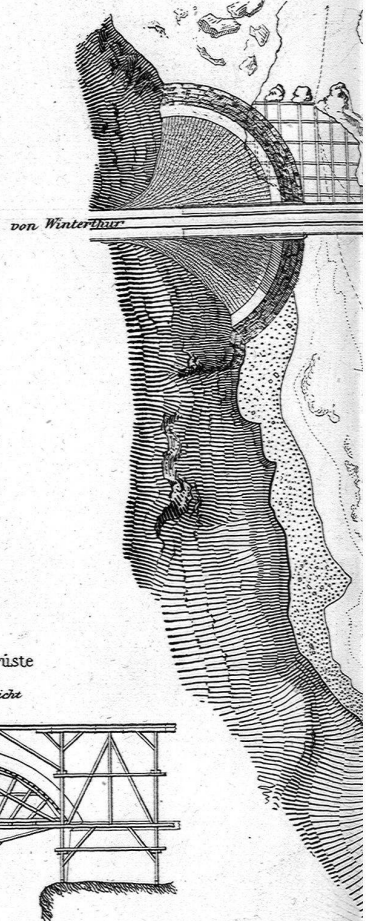
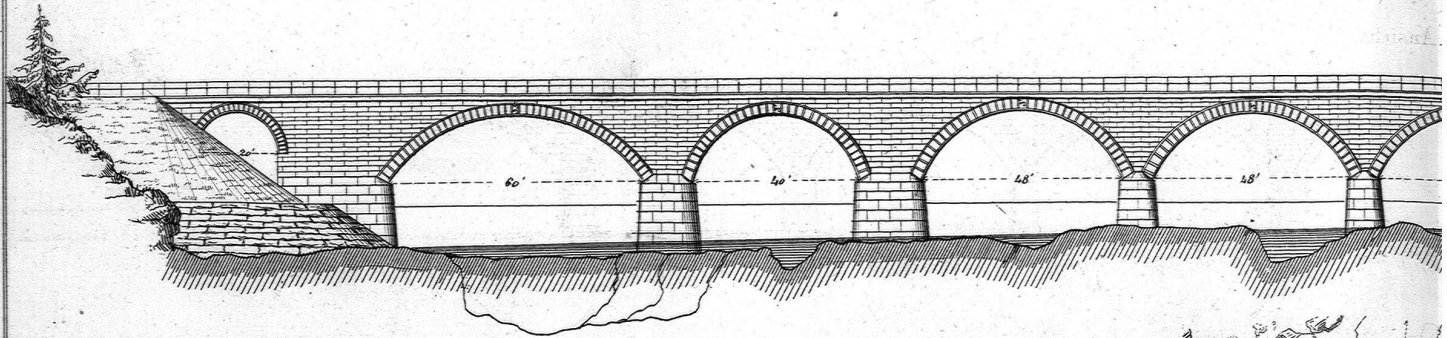

Fig. 22.



Probirofen von Peligot u. Levol

Maßstab  $\frac{1}{20}$



Querschnitt

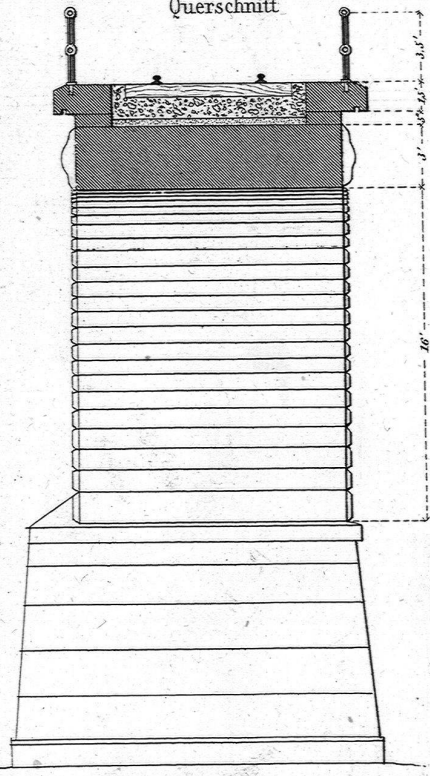

Gewölberüste  
Seitenansicht

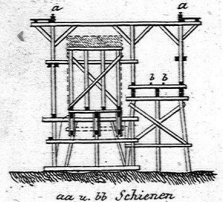

Gewölberüste  
Vorderansicht

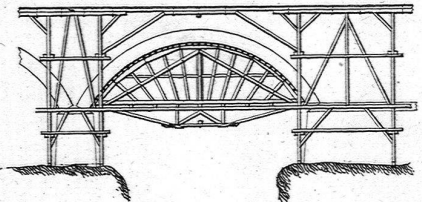

Längenschnitt

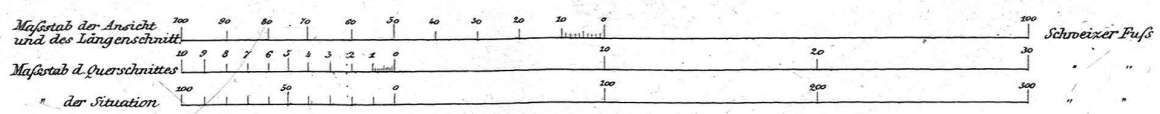
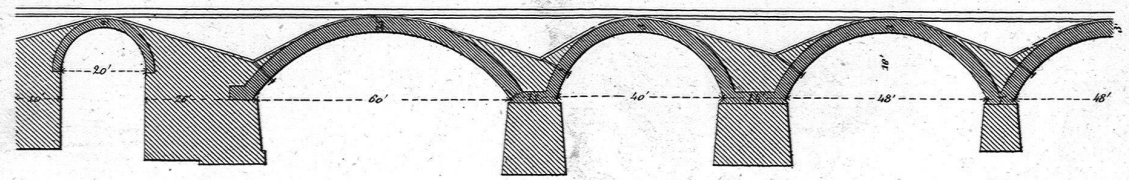

BEIM RHEINFALL.

Ansicht.

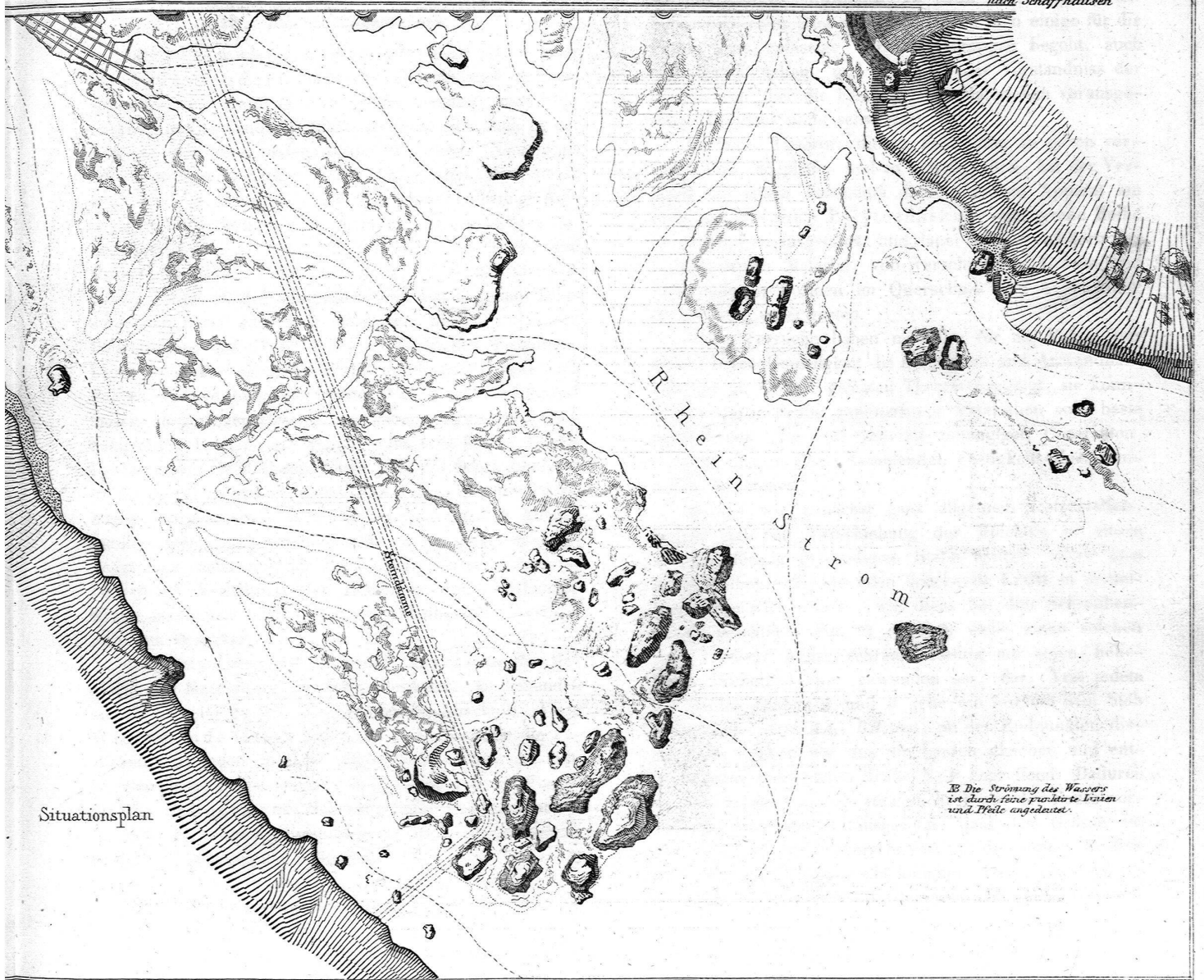
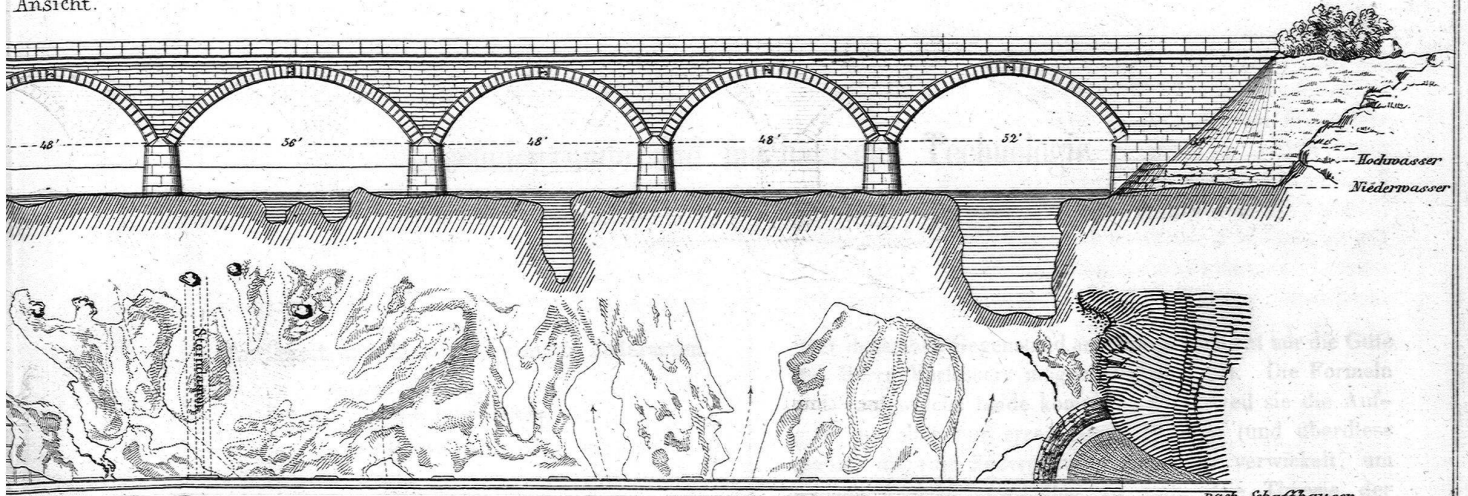

Situationsplan

Es Die Strömung des Wassers ist durch feine punktierte Linien und Pfeile angedeutet.