

Zeitschrift: Schweizerische Polytechnische Zeitschrift
Band: 9 (1864)
Heft: 2

Anhang: Tafeln

Nutzungsbedingungen

Die ETH-Bibliothek ist die Anbieterin der digitalisierten Zeitschriften. Sie besitzt keine Urheberrechte an den Zeitschriften und ist nicht verantwortlich für deren Inhalte. Die Rechte liegen in der Regel bei den Herausgebern beziehungsweise den externen Rechteinhabern. [Siehe Rechtliche Hinweise.](#)

Conditions d'utilisation

L'ETH Library est le fournisseur des revues numérisées. Elle ne détient aucun droit d'auteur sur les revues et n'est pas responsable de leur contenu. En règle générale, les droits sont détenus par les éditeurs ou les détenteurs de droits externes. [Voir Informations légales.](#)

Terms of use

The ETH Library is the provider of the digitised journals. It does not own any copyrights to the journals and is not responsible for their content. The rights usually lie with the publishers or the external rights holders. [See Legal notice.](#)

Download PDF: 18.03.2025

ETH-Bibliothek Zürich, E-Periodica, <https://www.e-periodica.ch>

Fig. 2. Schnitt nach

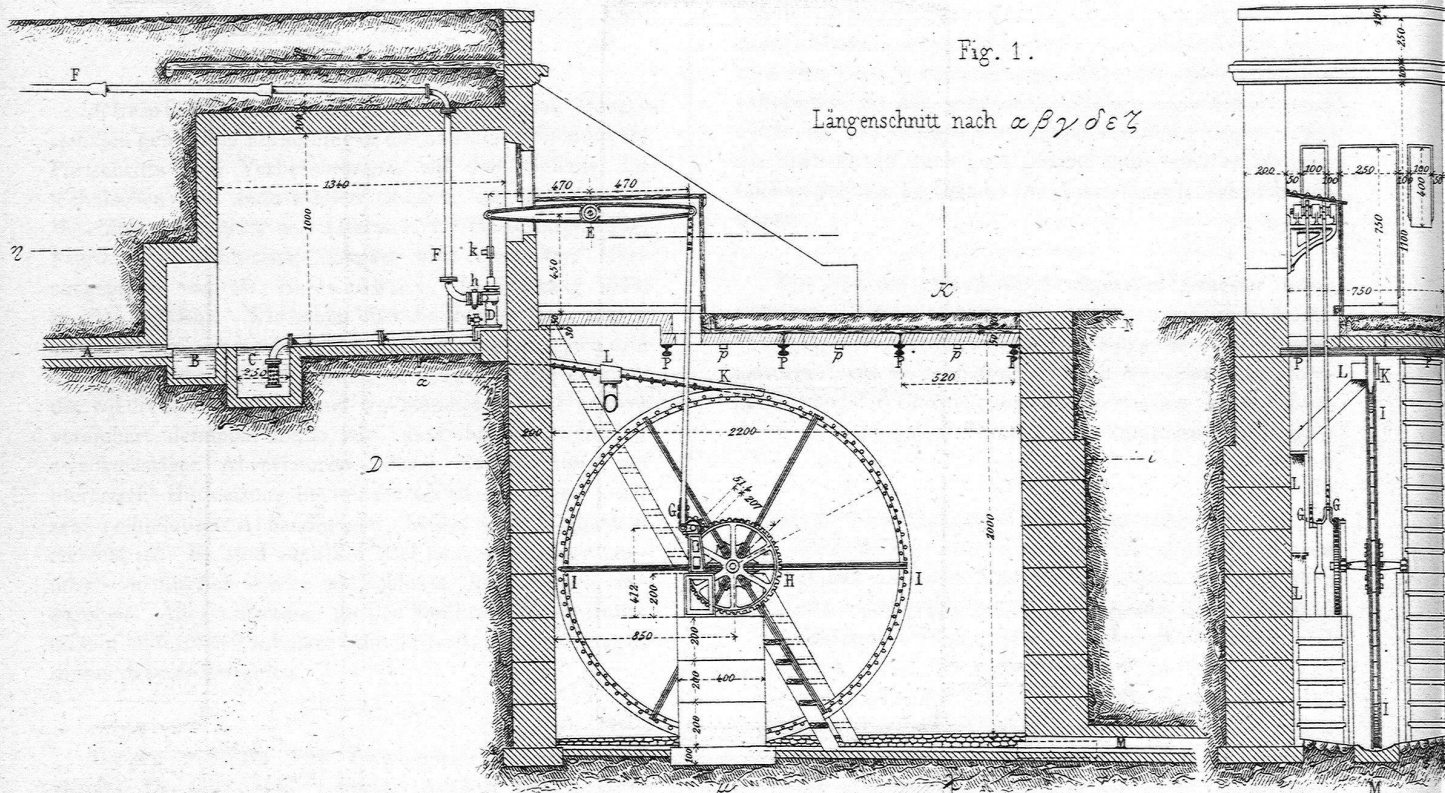

Fig. 3. Schnitt nach

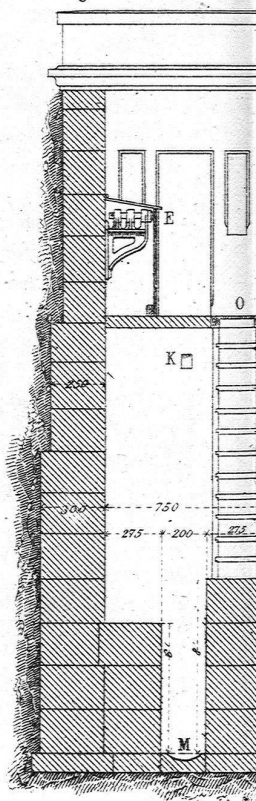

Fig. 4. Horizont. Schnitt nach ηE .

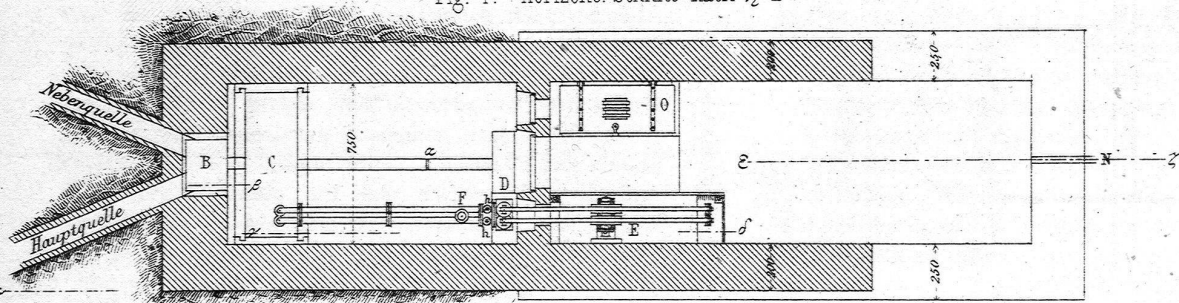
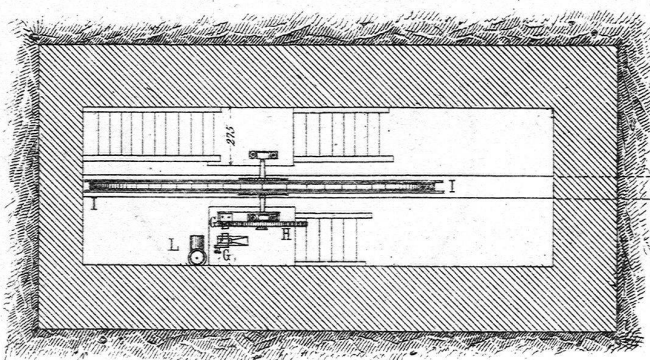

Fig. 5. Schnitt nach $D i$



AB. Die eingeschriebenen Maße sind in Linien (Schweiz) ausgedrückt.

K 2

Fig. 6. Durchschnitte des Reservoirs (1/25)

Fig. 7.

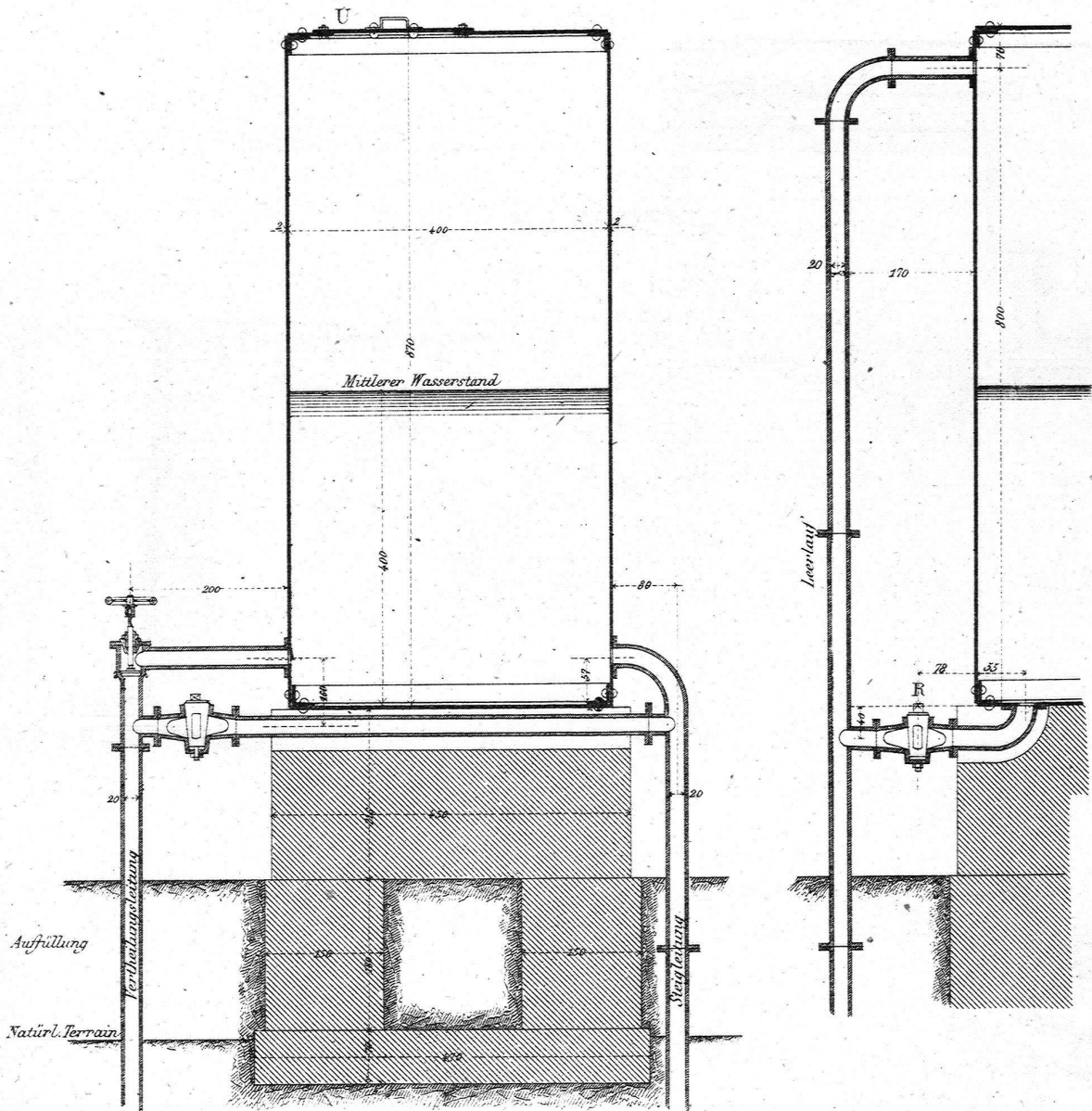

K μ

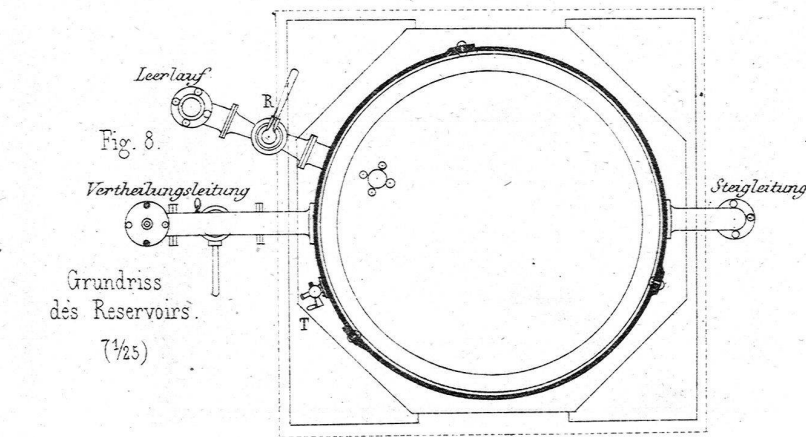

DIE
WASSERHEBUNGSANLAGE
IN DER LORRAINE
BEI BERN.

DIE WASSERHEBUNGSANLAGE IN DER LORRAINE.

BEI BERN.

Fig. 13. Situationsplan.

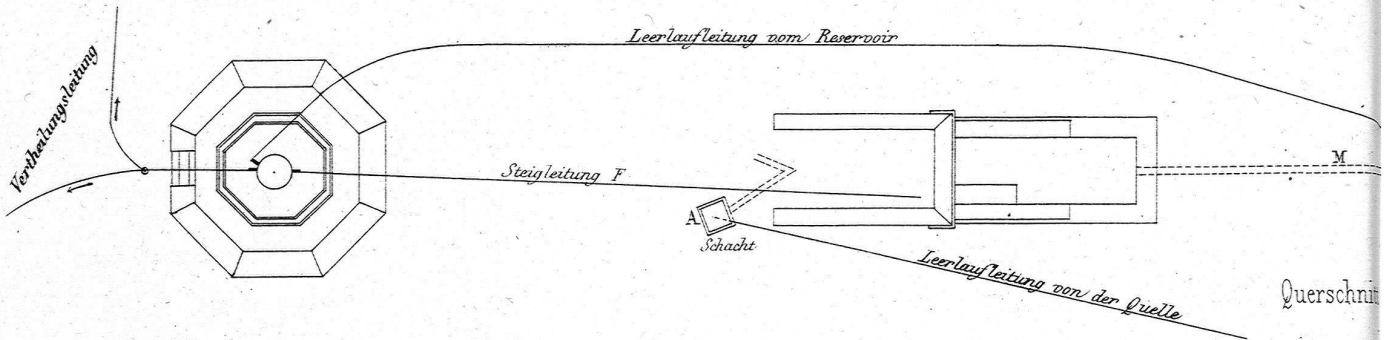
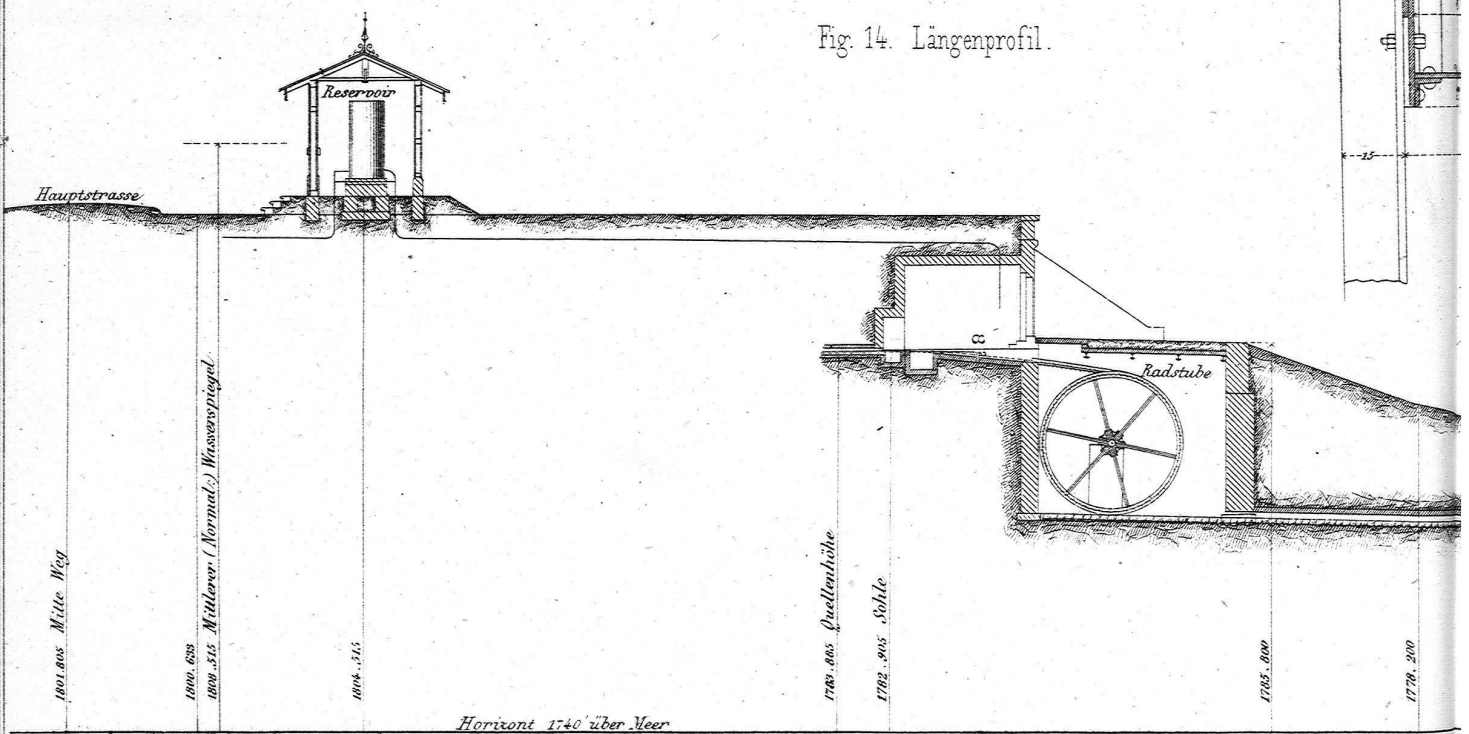
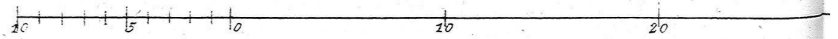

Fig. 14. Längenprofil.



Maisstab $\frac{1}{100}$ zu den Fig. 1-5.



Maisstab $\frac{1}{250}$ für die Längen & Höhen der Fig. 13 & 14

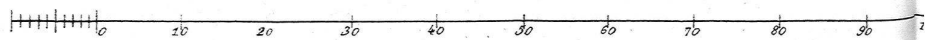

Die sämtlichen eingeschriebenen Maße sind in Linien.

Fig. 10. Grundriss der Pumpe (1/10)

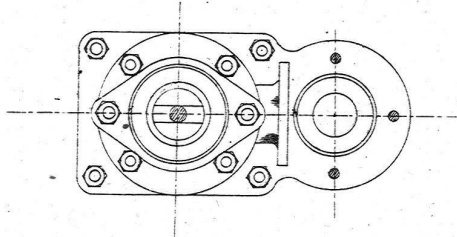

Fig. 9

Vertikaler Schnitt durch die Mitte der Pumpe. (1/10)

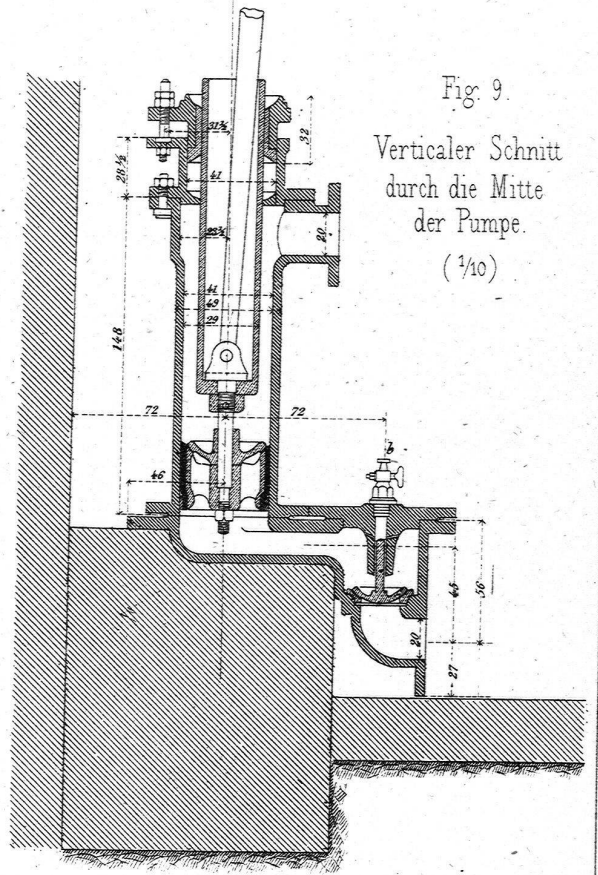

Fig. 12. des Wasserrades (1/5)

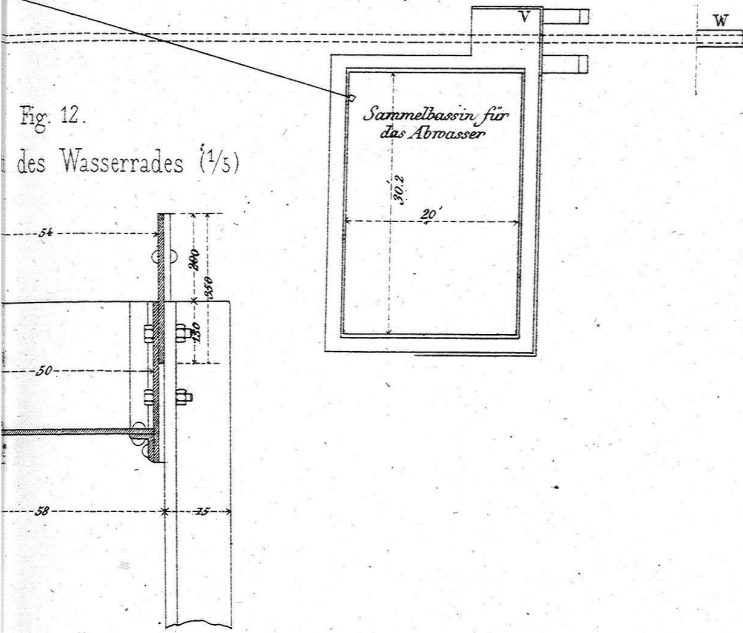
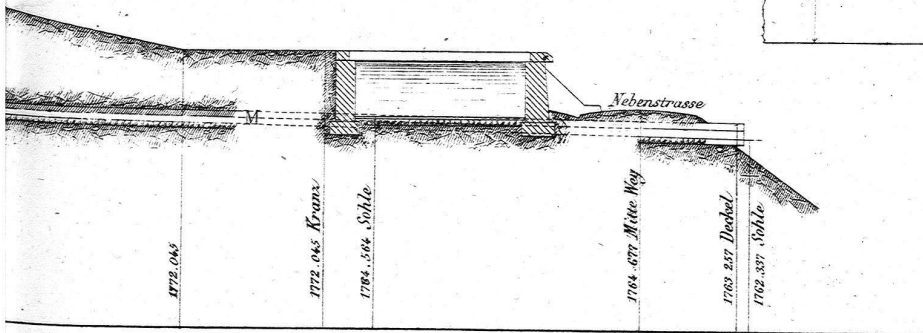
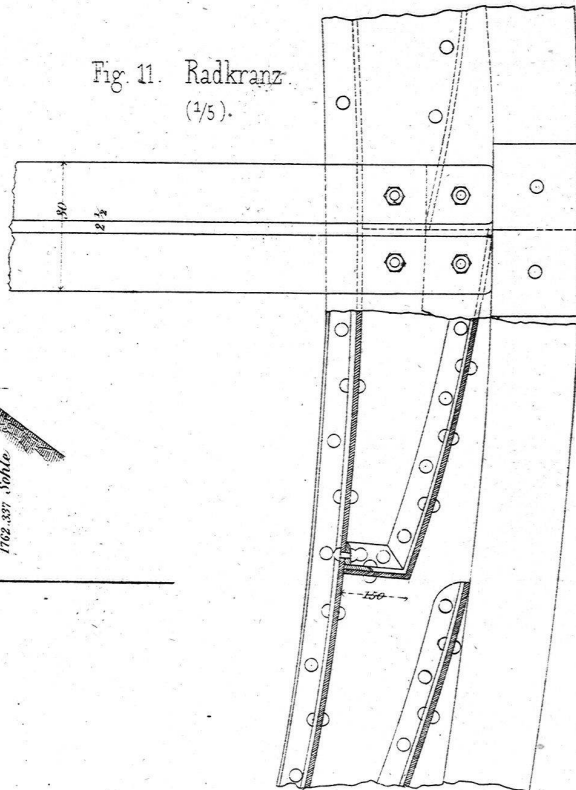

Fig. 11. Radkranz (1/5).



30
40 Fuss Schwell
100 110 120 130 140 Fuss
gedruckt.

C. Reishauer's Schrauben-Schneidzeuge.

Fig. 6. Vorderansicht der Schneidkluppe mit abgenommener Deckplatte.

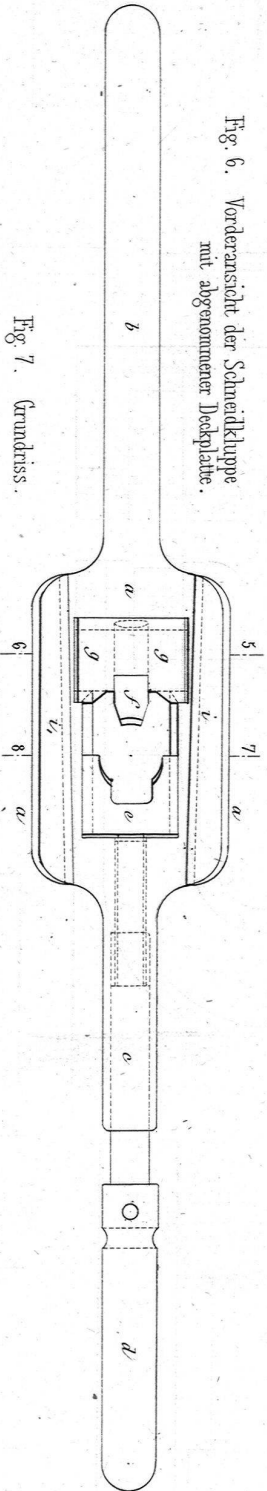

Fig. 7. Grundriss.

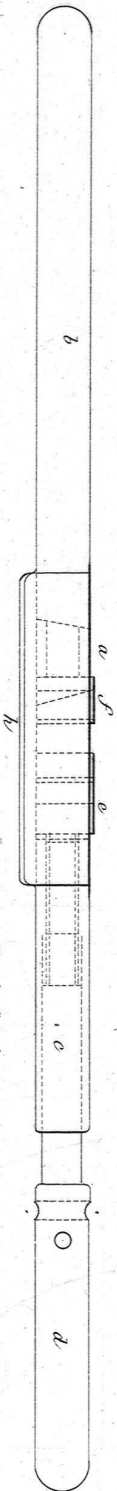

Fig. 11.

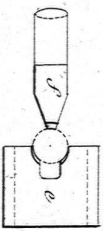

Fig. 12.

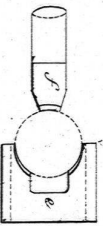

Fig. 8. Deckplatte.

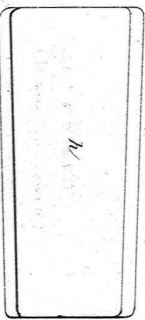

Fig. 9. Schnitt. 5-6

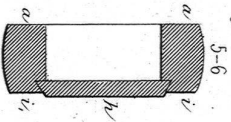

Fig. 10. Schnitt. 7-8

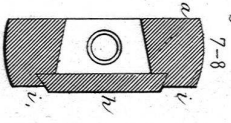

Fig. 13. Schneidbackenhalter:

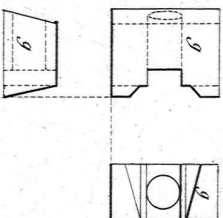

Fig. 1. Scheren- od. Charriekluppe.

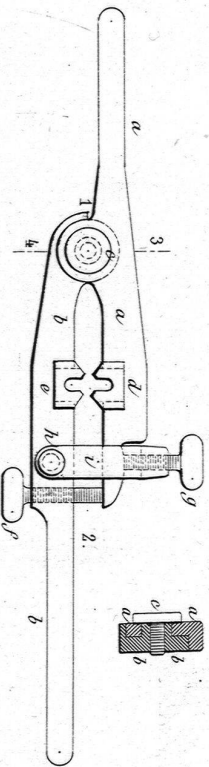

Fig. 3. Schnitt 3-4.



Fig. 4.



Fig. 5.



Fig. 2. Schnitt 1-2.

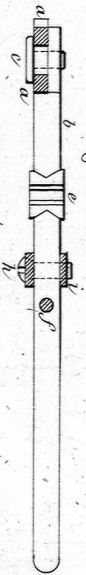

Maisstab = 3/5 zu den Figuren 1-13.

Fig. 14.

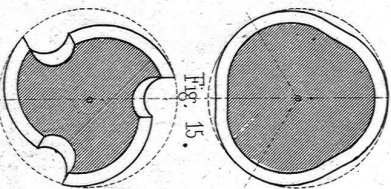

Fig. 16.

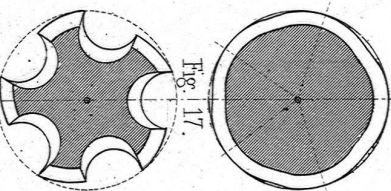

Fig. 18. Rebhaken.

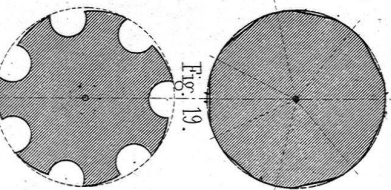

Fig. 15.

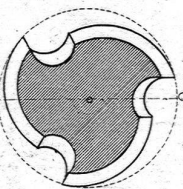

Fig. 17.

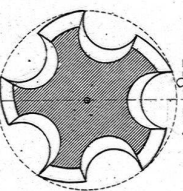
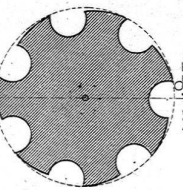

Fig. 19.



Türsch. Turbinenanlage bei sehr veränderlicher Wasserkraft.

Fig. 3.

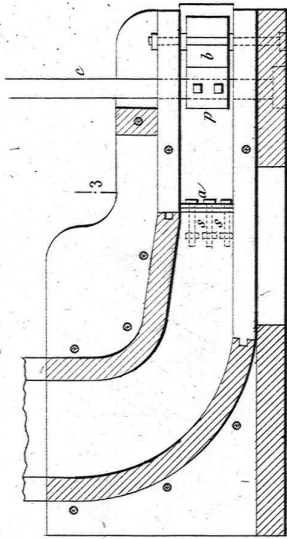

Fig. 6.

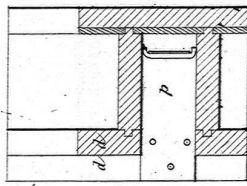

Fig. 7. Schmiede Esse mit Luftregulirung.

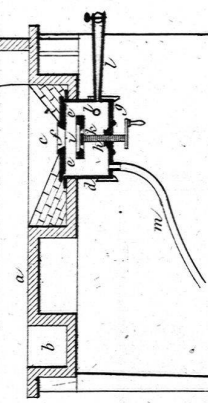

Fig. 2.

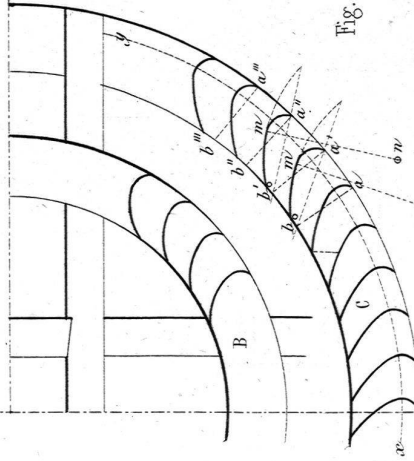

Fig. 5.

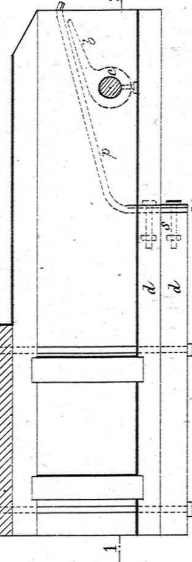

Fig. 13.

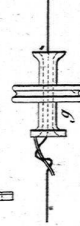
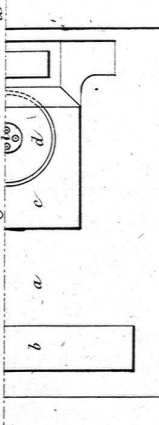

Fig. 8.



Syke's Spinnmaschine für Streichgarn.

Fig. 14.

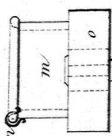

Fig. 15.



Fig. 10.

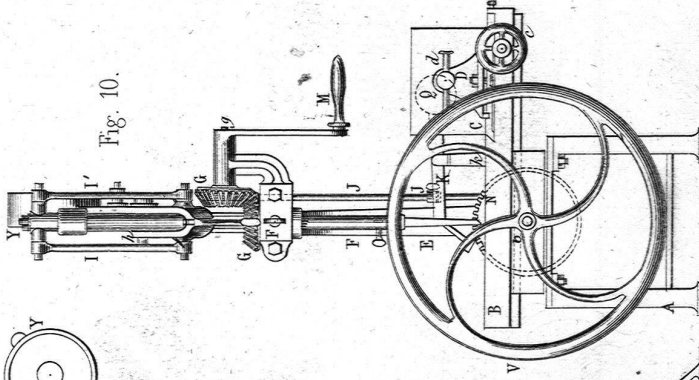

Fig. 9.

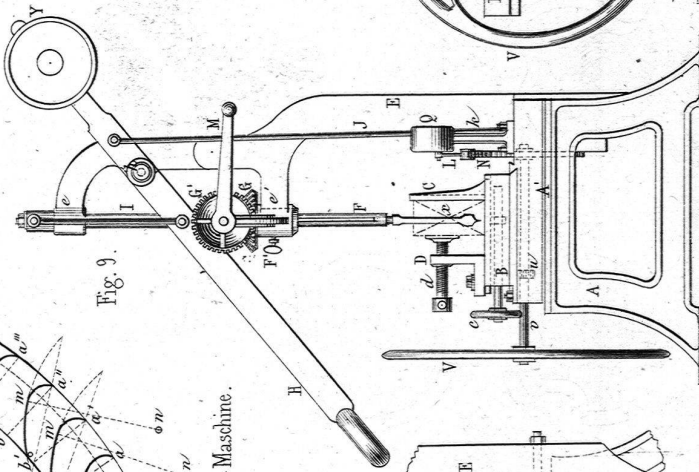
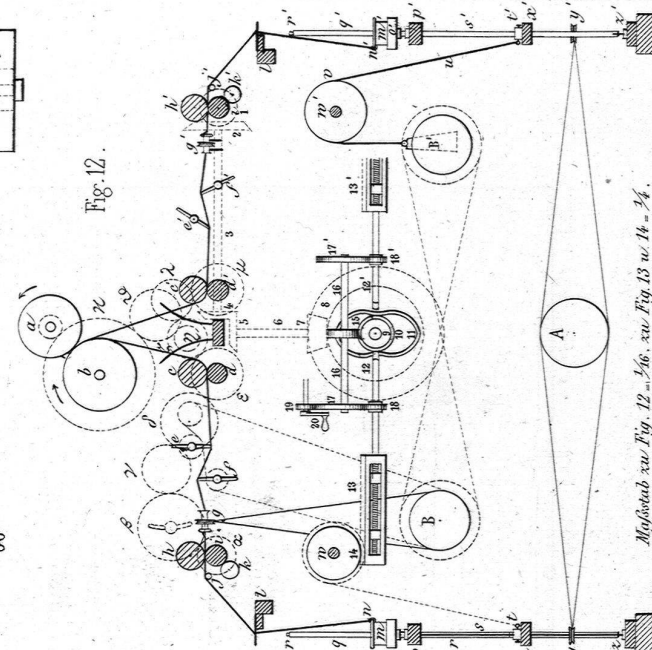
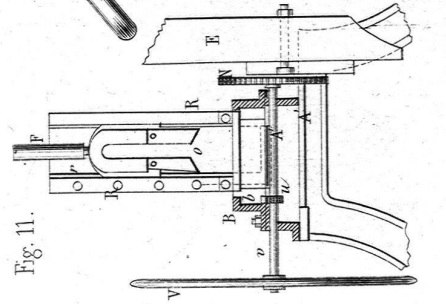

Fig. 12.



James' Bohr- & Stemm-Maschine.

Fig. 11.



Mohrstab aus Fig. 12. 2/6. zu Fig. 13 u. 14. 1/4.

Lith. Anstalt v. Wustler, Randegger & Co. in Winterthur.

DIE ORGANISIRTEN FERMENTE DER KRANKHEITEN DES WEINES.
von Pasteur.

