

The laboratory of hydraulics, hydrology and glaciology (VAW) in Zurich

Autor(en): **Hutter, Kolumban / Huber, Andreas / Jäggli, Martin**

Objektyp: **Article**

Zeitschrift: **Wasser Energie Luft = Eau énergie air = Acqua energia aria**

Band (Jahr): **79 (1987)**

Heft 7-8

PDF erstellt am: **21.07.2024**

Persistenter Link: <https://doi.org/10.5169/seals-940647>

Nutzungsbedingungen

Die ETH-Bibliothek ist Anbieterin der digitalisierten Zeitschriften. Sie besitzt keine Urheberrechte an den Inhalten der Zeitschriften. Die Rechte liegen in der Regel bei den Herausgebern.

Die auf der Plattform e-periodica veröffentlichten Dokumente stehen für nicht-kommerzielle Zwecke in Lehre und Forschung sowie für die private Nutzung frei zur Verfügung. Einzelne Dateien oder Ausdrucke aus diesem Angebot können zusammen mit diesen Nutzungsbedingungen und den korrekten Herkunftsbezeichnungen weitergegeben werden.

Das Veröffentlichen von Bildern in Print- und Online-Publikationen ist nur mit vorheriger Genehmigung der Rechteinhaber erlaubt. Die systematische Speicherung von Teilen des elektronischen Angebots auf anderen Servern bedarf ebenfalls des schriftlichen Einverständnisses der Rechteinhaber.

Haftungsausschluss

Alle Angaben erfolgen ohne Gewähr für Vollständigkeit oder Richtigkeit. Es wird keine Haftung übernommen für Schäden durch die Verwendung von Informationen aus diesem Online-Angebot oder durch das Fehlen von Informationen. Dies gilt auch für Inhalte Dritter, die über dieses Angebot zugänglich sind.

The Laboratory of Hydraulics, Hydrology and Glaciology (VAW) in Zurich

The Laboratory of Hydraulics, Hydrology and Glaciology (VAW) of the Swiss Federal Institute of Technology (ETH) was founded in 1930 by Professor *E. Meyer-Peter*, famous for his work on sediment transport.

The Laboratory is divided into three departments: Hydraulics, Water Resources, and Glaciology. The number of permanent and temporary staff is about 70. An extensive infrastructure (including library, workshop, and data processing facilities) provides the necessary support for the efficient functioning of the Laboratory.

While involved in lecturing, the Laboratory deals mainly with applied research in the fields of civil engineering, rural engineering and earth sciences. Research programs are often based on contracts, but are also set up from within the Laboratory. They result in various contributions to the design of hydraulic structures, the evaluation of river behaviour, the planning of flood protection measures, and the explanation of glacier movements.

The *Hydraulics Department*, extensively involved in activities of concern to IAHR, has wide ranging experience in many aspects of hydraulic engineering. Hydraulic computations and model tests are performed for dams, hydro-power projects, river training works, torrent control, and urban drainage systems. Some of the topics currently receiving special emphasis are spillway aeration, vortex prevention, flow induced vibrations, sediment transport on steep slopes, and allowing trained rivers to revert to more natural forms.

In the *Water Resources Department* current research projects concern among other things, mathematical models of dam break waves, gravel river behaviour, lake currents, runoff processes in small catchments, and flow through porous and fractured media.

The *Glaciology Department* is less related to IAHR-activities. Nevertheless, it deals with the interesting hydraulics of intra- and subglacial channels and with the flow along the glacier bed.

A special group is involved in simulating powder snow avalanches in a water tank and in modelling rock falls and rock fall induced waves in lakes and reservoirs.

The following paragraphs give some specific examples of the activities of the Laboratory. Prof. Dr. *Daniel Vischer*

Landslides and avalanches:

Their induced wave motion in reservoirs

Landslides and avalanches are a recurring threat to alpine inhabitants. They may either directly endanger certain areas or, when plunging into lakes or reservoirs, give rise to secondary hazards such as large amplitude waves which may also cause floods if dams are overtopped.

Laboratory experiments with landslides and avalanches

Because of the danger that goes along with these catastrophes, and also because of their unpredictability, calibration of theoretical models of the avalanching motion of soil or snow by means of field data is hardly possible. Laboratory experiments serve as tests of the models. One differentiates between landslides and flow avalanches (of snow), and powder snow avalanches.

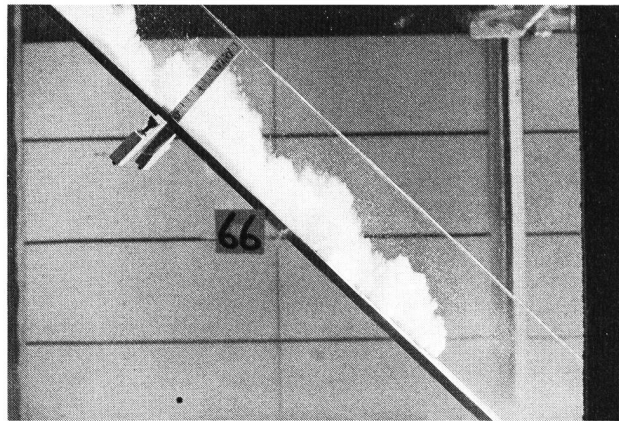

Figure 1. Moving laboratory powder snow avalanche.

Figure 1. Avalanche de neige poudreuse reproduite en laboratoire.

Bild 1. Niedergehende Staublawine; Modellversuch im Labor.

Figure 2. Schematic representation of the experimental equipment for measurements of laboratory avalanches.

Figure 2. Schéma de l'appareillage utilisé pour les mesures de laboratoire concernant les avalanches.

Bild 2. Schematische Darstellung der Versuchsanlage zur Ausmessung von Laborstaublawinen.

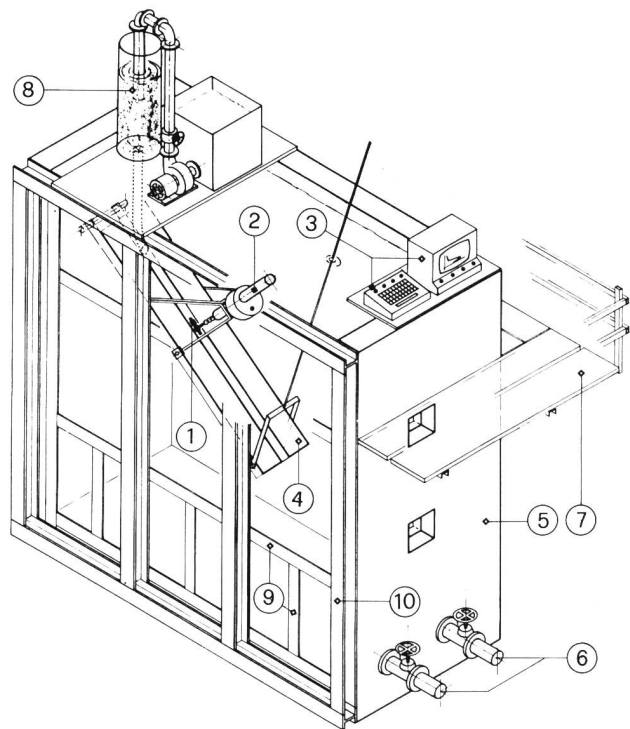

- 1 Transducer / capteur / Transducer
- 2 Waterproof box with step-drive motor / mécanisme de positionnement / Transportmechanismus
- 3 Microprocessor / computer et instrumentation électronique de mesure / Computer und Messelektronik
- 4 Chute / canal / Rinne
- 5 Tank / réservoir / Tank
- 6 Bottom outlet / Vidange / Ausguss
- 7 Gangway / plateforme / Galerie
- 8 Feed apparatus / mélangeur neige-eau / Schnee-Wasser-Mischapparat
- 9 Interior steel frame / ossature métallique intérieure / innere Verstrebrungen
- 10 Exterior steel frame / ossature métallique extérieure / äussere Verstrebrungen

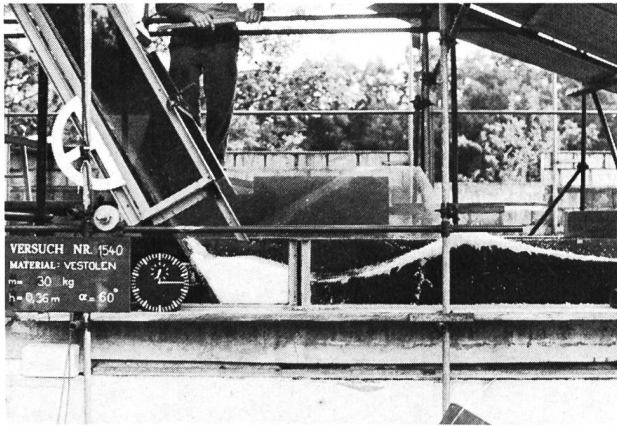

Figure 3. Impulse wave generation by a plunging ice mass in a two-dimensional model.

Figure 3. Ondes de translation engendrées par une masse de glace dans un modèle bidimensionnel.

Bild 3. Schwallwellenerzeugung durch eintauchende Eismassen im zwei-dimensionalen Modell.

Landslides and flow avalanches are reproduced in the laboratory by the motion of a finite mass of granules (sand, plastic particles, glass beads) down an inclined chute or modelled topography. Video-films and photographic reproduction of the entire motion under various different external conditions (variation of inclination angle, surface roughness, plasticity of the particles, etc.) permit estimation of the significance of these parameters for the motion, the spreading of the mass and the details of the configuration of the settling zone. Theoretical models agree favourably with some of these tests.

The mechanics of powder snow avalanches are simulated in the laboratory as a turbulent flow of polystyrene particles (snow) along a chute which is submerged in quiescent water (air) (figure 1). Ultrasound techniques are employed to measure particle velocities and densities within the avalanche along its track (figure 2), and photogrammetric techniques are used to determine the distribution of the settled snow in the settling zone. Two phase models are calibrated with the aid of such experiments.

For the generation of impulse waves in reservoirs and natural lakes the impact that is exerted by such avalanches and rock slides on open waters is also analysed in 2- and 3-dimensional models. Propagation and characteristics of these waves are investigated (figure 3).

PD Dr. Kolumban Hutter and Dr. Andreas Huber

Fluvial hydraulics

Design of block ramps

Extreme narrowing of river courses, dredging and other man-made influences often lead to substantial erosion in gravel rivers. Erosion control is often effected by means of drop structures, among which block ramps are becoming increasingly popular. However, failures of such structures have given rise to a certain scepticism. Traditionally, such drop structures were built of concrete, steel and wood and were fixed structures. Since an environmentally concerned public views rivers more and more as landscape elements rather than pure flood evacuation canals, more flexible solutions like these block ramps are envisaged.

Flexible solutions in river training require more understanding of the bed forming processes and investigations into new design methods. This is why the laboratory concentrates on numerical modelling for predicting river bed

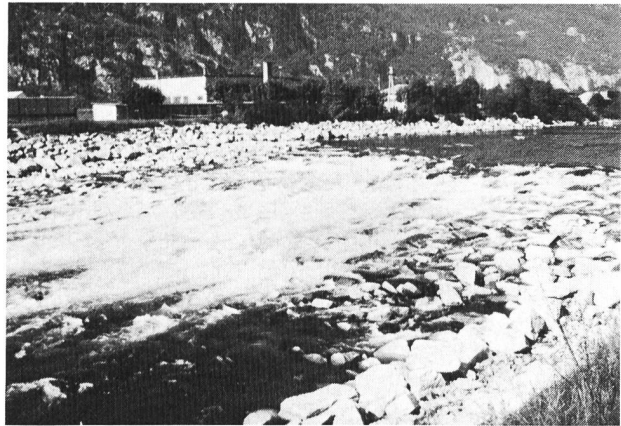

Figure 4. Block ramp near Lodrino on the Ticino river, built to stabilize a drop of about 5 m.

Figure 4. Rampe en enrochements près de Lodrino sur la rivière Ticino, construite pour stabiliser une chute d'environ 5 m.

Bild 4. Blockschwelle bei Lodrino im Tessin, mit einer Absturzhöhe von etwa 5 m.

changes on one hand, and on physical model investigations for particular design situations on the other hand.

In the present case, a laboratory investigation showed, that three mechanisms can individually or in combination lead to the destruction of block ramps. Direct erosion of a loose block out of the ramp is a particular case of the well known problem of incipient motion. Sufficient block weights usually prevent this erosion. However the interface to the underground material may become critical if the number of blocks used on a certain area is too small. Blocks may then embed or slide off. The tests allowed the necessary requirements in terms of block weight and density to be specified. Finally, the scour problem at the end of the ramp may be determining for the stability. If the toe of the ramp is not sufficiently submerged and an acceleration results over the last row of blocks, again destruction will result.

As shown in figure 4, ramps of considerable size can be built using the criteria developed.

Dr. Martin Jäggi

Debris flow behaviour

An earlier research program at the laboratory led to the establishment of a sediment transport formula for steep slopes. The experiments were conducted with clear water and gravel.

Debris flows occur if sediment availability is high and the bed slope exceeds a certain value. The literature distinguishes between low and high density debris flows. The earlier tests appear to simulate to a certain extent the low density debris flows with more or less steady transport. However, it is known that the flow behaviour and transport mechanism in high density debris flows are substantially different. The presence of fine sediment in the water changes the density and viscosity of the fluid.

In a new flume investigation the effect of a slurry of fine material on the flow behaviour and the sediment transport capacity is now being studied. By gradually increasing the slurry concentration it is hoped that the transitional conditions to high density debris flows can be studied.

Dr. Martin Jäggi and Dieter Rickenmann, dipl. Ing.

Model tests on spillway aerators

A topical contribution to dam hydraulics

The past decade has witnessed an increase in the height of dams for power plants and in the specific flow rates in spillways. Project designs now allow for spillway flows of up to

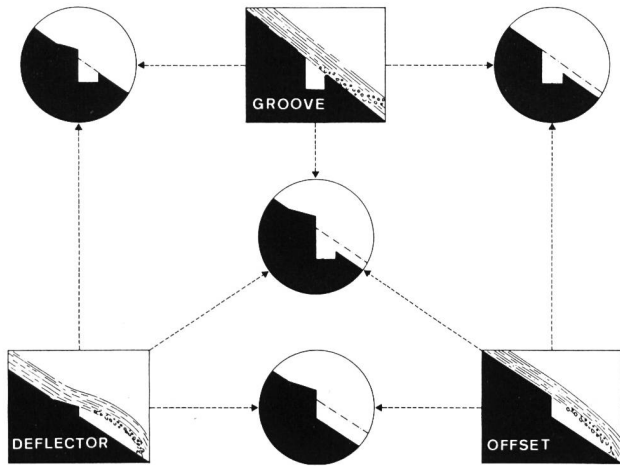

Figure 5. Main aerator shapes.

Figure 5. Formes constructives de différents aérateurs.

Bild 5. Bauformen von Belüftern.

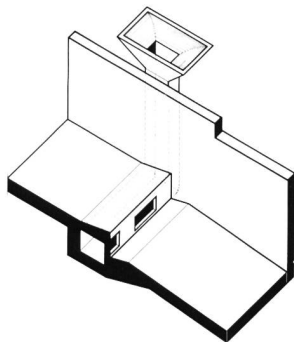

Figure 6. Aerator (ramp), supply system and air duct.

Figure 6. Configuration du radier, conduit d'aménée et système de distribution de l'air.

Bild 6. Sohlenrampe, Verteilsystem und Luftzufuhrschacht.

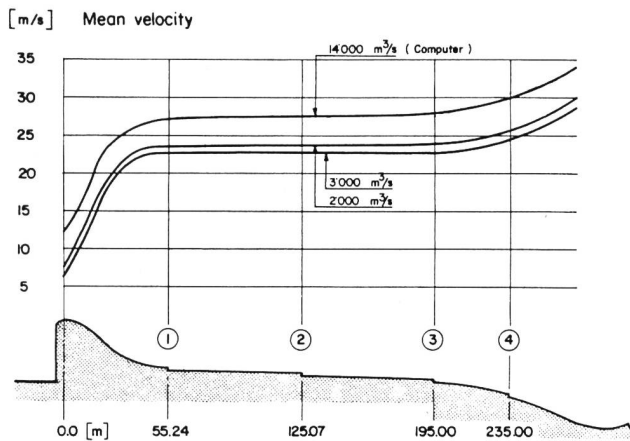

Figure 7. Mean flow velocities and position of the aerators, from the VAW report on the Piedra del Aguila Spillway.

Figure 7. Vitesses moyennes de l'écoulement et disposition des aérateurs; exemple tiré du rapport VAW pour l'évacuateur de crues de Piedra del Aguila.

Bild 7. Mittlere Strömungsgeschwindigkeiten und Anordnung der Belüfter; Beispiel aus einem VAW-Bericht über die Piedra del Aguila Schussrinne.

Figure 8. Detail from a VAW study for the Mosul Dam Spillway.

Figure 8. Détail d'un aérateur, évacuateur de crues du barrage de Mosul.

Bild 8. Details eines Sohlenbelüfters, Mosul Damm, Schussrinne.

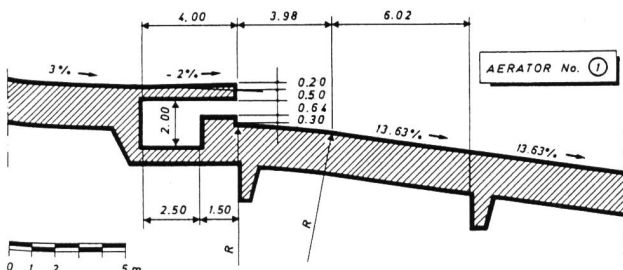

100000m³/s. Consequently flow velocities in prototype concrete spillway chutes can now attain values of 50 m/s.

As the flow velocity at the boundary of a hydraulic structure increases towards such extreme values the potential for damage to the structure by cavitation erosion also increases, and cavities in a concrete surface can reach depths of several meters within a relatively short time. The inception of cavitation erosion depends to a large extent on the surface finish of the structure but with flow velocities greater than 22 to 26 m/s protection of the flow boundary by means of lining critical areas or using resistant materials is neither economical nor completely successful.

In spillways, it has become usual to protect the spillway surface from cavitation damage by increasing the compressibility of the fluid near the spillway floor section through aeration. This aeration is effected by devices called "aerators" which are located on the spillway bottom and sometimes on the side walls.

As schematically shown in figure 6, the flow is deflected from the floor by a ramp. The lower surface of the flow develops instabilities and these break up into droplets and entrain air bubbles. This air demand is satisfied by a flow from the sides of the spillway through a duct, and the flowing air results in a head loss along the duct and subatmospheric pressure at the point of entrainment.

Of course, every project is unique but the goal of all aerators is to guarantee a sufficient air concentration at the most vulnerable locations. This is a typical starting-point for hydraulic model tests. For a certain spillway chute the special questions in mind are then as follows:

- determination of the mean flow velocity as a function of position along the chute,
- definition of the position of the first aerator,
- design of the first aerator and its air supply system. To this end the bottom air concentration should serve as a fundamental criterion,
- determination of the subsequent aerators' position and shape,
- determination of the jet trajectories,
- check under conditions of lower discharge or non-symmetrical flow.

During the last few years the VAW investigated several projects by model testing, and the specialized members of the staff were asked to work as consultants on aerators worldwide. It should be pointed out that our wide experience on this topic is based on the lab's fundamental scientific research as well as on our connections with the engineering

Figure 9. Special aeration device placed at a discontinuity in the chute slope. VAW investigation on the Aghios Nikolaos Dam Spillway Chute.

Figure 9. Aérateur de forme particulière placé à la cassure de pente d'un coursier. Evacuateur de crues du barrage Aghios Nikolaos.

Bild 9. Sonderausführung eines Belüfters an einem einspringenden Knick im Längenprofil der Schussrinne. Aghios Nikolaos Schussrinne.

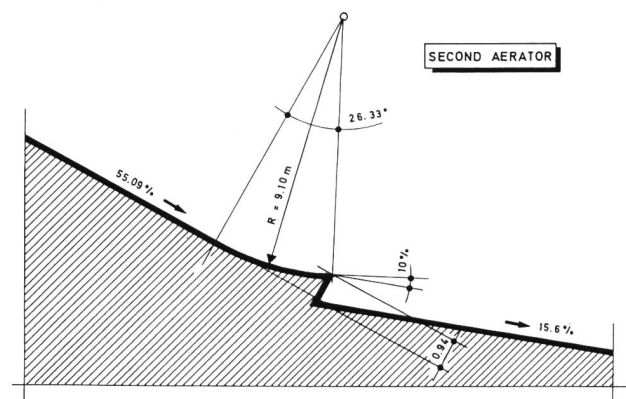

practice. One of the further important requirements which the lab possesses, is the instrumental set-up necessary for measuring and analysing air concentrations and dynamic pressures.

In the future the use of more efficient computer software in this field is foreseen and a more intense transfer of knowledge to students in engineering has started.

Dr. Peter Volkart

Simulation of flood waves

Models for predicting the flow characteristics of flood waves are of great importance in hydraulic engineering. They are useful tools for designing flood control projects. In order that measures and plans for flood protection are appropriate to a natural flood event or even to the disaster of a breached dam, the height and velocity of a potential flood wave should be known. These quantities can be evaluated

from physical or mathematical models. The latter are usually used if the flow behaviour over a reach of more than several kilometers is to be determined.

At VAW a computer program called *Floris* is used for the numerical simulation of flood waves. The first version of the program was developed in cooperation with a Swiss consulting engineering company. *Floris* is based on the full one-dimensional differential equations of Saint-Venant. They are integrated with an implicit difference scheme. To facilitate this every river branch must be divided into intervals. At the boundary of each interval the river geometry is defined by the corresponding cross-sectional profile. In most cases a good approximation of a dambreak flood flow is given by the one-dimensional form of Saint-Venant's equations. Two-dimensional effects, such as the inundation of a flood plain, can be simulated by an appropriate network of nodes and river branches. Nodes are particular points, e.g. junctions, bifurcations, weirs, bridges, and so on, where the Saint-Venant equations are replaced by other relevant relationships. The failure of a dam can be represented by a specific node type "dam", which allows a time-dependent description of the shape of the breach. The reservoir upstream of the dam is considered as a river branch, so that the lowering of the headwater level is simulated too.

In the latest version of VAW's *Floris* both subcritical and supercritical flow, and the change from either of these states to the other, can be simulated. Thus the wandering of a hydraulic jump can be predicted. These facilities are very useful for the simulation of dambreak flood flows (figure 10). Basically, the program *Floris* calculates, over a specified time period, the discharge (Q) and the water level (z) at all the given cross-sections. From this data the desired results, for example the hydrographs $Q_i(t)$ and $z_i(t)$ for a particular river position x_i , or the longitudinal profile of the highest water level, can be evaluated. In this way the behaviour of the flow and the extent of a potential inundation can be determined. Of course the results depend on various parameters and boundary conditions, which can hardly all be known exactly in advance for the critical flood event. But the influence of these parameters and conditions can be satisfactorily estimated by varying them in systematic computer simulations. By this means the simulations give a view of the range of possible flood wave impacts.

Dr. Anton Kühne and Roland Föh, dipl. Ing.

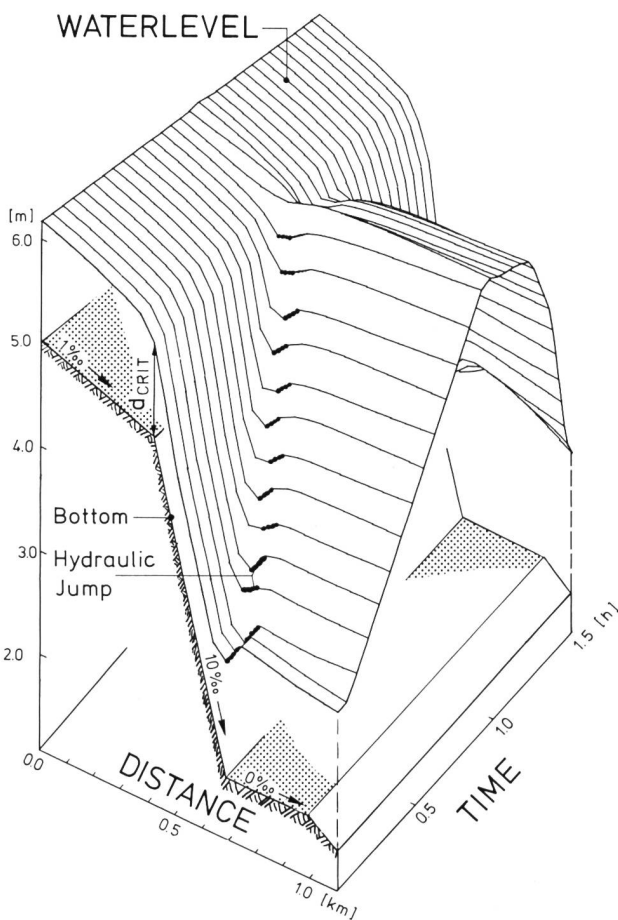

Figure 10. Three dimensional representation of the calculated waterlevel in the case of a river branch whose central part is so steep, that it has supercritical flow. As the waterlevel at the downstream end of the river increases, the hydraulic jump moves upstream until there is subcritical flow over the whole of the river reach.

Figure 10. Représentation tridimensionnelle du niveau d'eau calculé sur un tronçon de rivière dont la partie médiane fortement inclinée entraîne la formation d'un écoulement torrentiel. Suite au rehaussement de ce niveau à l'extrémité inférieure du cours d'eau, le ressaut se déplace vers l'amont jusqu'à ce que l'écoulement tranquille s'installe sur l'ensemble du tronçon.

Bild 10. Dreidimensionale Darstellung des berechneten Wasserspiegels für einen Flussast, dessen mittlerer Teil so steil ist, dass dort schiessende Abflussverhältnisse vorliegen. Da der Wasserspiegel am unteren Ende des Flusses angehoben wird, bewegt sich der Wassersprung so lange flussaufwärts, bis der Fliesszustand auf der ganzen Strecke strömend wird.

River-induced currents and sedimentation processes in lakes and reservoirs

Extensive studies of suspended matter and its sedimentation in lakes indicate that sediment input by tributary rivers can be a notable factor controlling the water quality in many lakes. It is therefore essential to know the behaviour of the river water after it has been injected into a lake and especially the depth of the intrusion and dispersal into the open lake (figure 11).

In thermally stratified lakes one can expect two main modes of river water inflow: a) Under normal discharge conditions the river water will be injected at the boundary between the warm upper layer (epilimnion) and the cold lower layer (hypolimnion), the river water will form an *interflow* at the thermocline. b) During flood surges the concentration of suspended sediments in the tributary may increase drastically. As a consequence, the river water can become denser than the deepest water layers of the lake and therefore continue as a density *underflow* following the slopes of the delta.

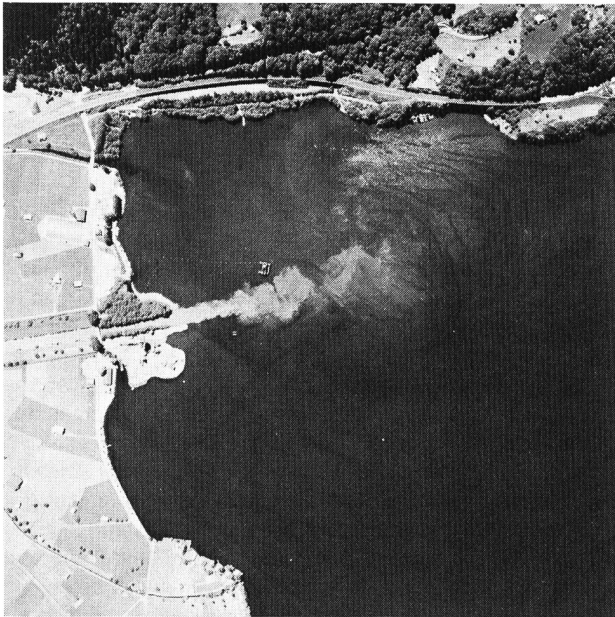

Figure 11. Inflow of the cold, sediment-laden Aare river into Lake Brienz, forming a sinking plume of turbid water.

(By courtesy Kraftwerke Oberhasli AG)

Figure 11. L'eau froide de l'Aar chargée de sédiments forme une plume turbide plongeante dans le lac de Brienz.

(Photo mise à disposition par Kraftwerke Oberhasli AG)

Bild 11. Das kalte und schwebstoffbefruchtete Aarewasser taucht als Dichtestrom in den Brienzensee.

(Reproduziert mit Genehmigung der Kraftwerke Oberhasli AG)

Figure 12. Multiparameter profiling 350 m NNW of the Rhone river mouth in Lake Geneva. The top of the interstratified river water is characterized by a sudden increase of turbidity and current velocity as well as a decrease of water temperature at about 9 m depth. NNW current directions are due to the inertial motion of the injected river water.

Figure 12. Profils multiparamétriques, 350 m au NNW de l'embouchure du Rhône dans le lac Léman. L'eau du Rhône interstratifiée provoque une augmentation rapide de la turbidité et de la vitesse du courant ainsi qu'un abaissement marqué de la température à partir de 9 m de profondeur. La direction NNW du courant documente l'inertie de l'eau du Rhône injectée dans le lac.

Bild 12. Profilaufnahmen verschiedener Messgrößen, 350 m NNW der Rhonemündung im Genfersee. Das eingeschichtete Flusswasser zeichnet sich durch sprunghafte Zunahme der Trübung und der Strömungsgeschwindigkeit sowie durch eine markante Abnahme der Temperatur in etwa 9 m Tiefe aus. Die nach NNW gerichtete Strömung dokumentiert den Strahl des einflussenden Rhonewassers.

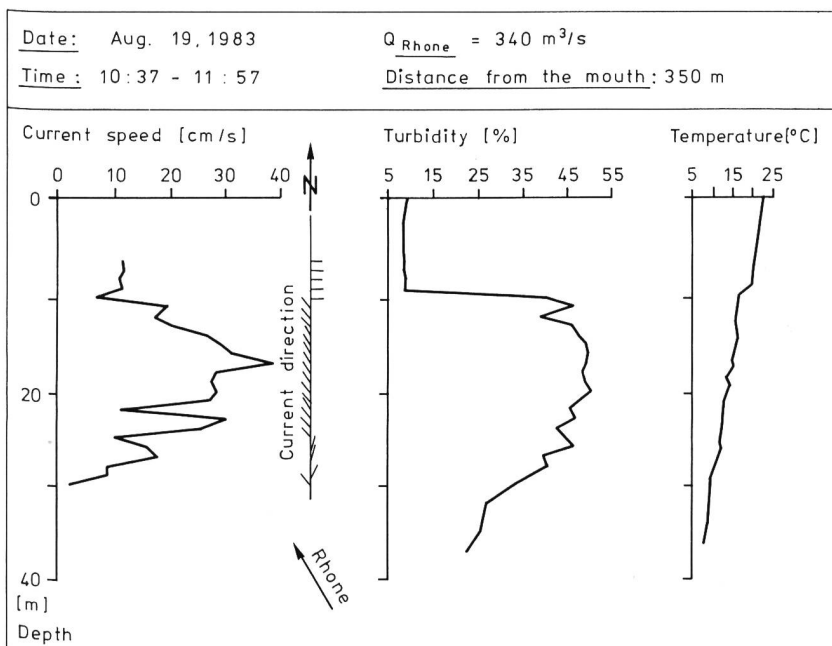

In order to study these phenomena in Lake Geneva an ultrasonic current meter was first of all applied to detect and measure the interflow of the Rhone river occurring close to the thermocline (at depths of 10 to 30m) during the period of lake water stratification. The results of this study mainly showed that currents caused by the momentum of the inflowing river water were clearly discernible up to a distance of about 1 km from the river mouth (figure 12).

The second part of the project aimed to monitor turbidity currents cascading down the slope of the delta during floods of the Rhone river. For this purpose self recording current meters and temperature sensors were anchored at different depths within the main canyon of the delta.

The results of these measurements confirmed sporadic occurrences of near-bottom downslope water flows (figure 13). Two different types of currents seem to exist, the first

Figure 13. Underflow of dense river water following the slopes of the Rhone delta, recorded 5 km west of the mouth at 200 m depth in Lake Geneva. This event, due to the flood of 7 June 1985 ($620 \text{ m}^3/\text{s}$), is characterized by increased current velocity and temperature between 10.30 and 16.00 h.

Figure 13. Enregistrement d'un courant de densité dans le delta du Rhône du lac Léman. L'événement, mesuré à 5 km à l'ouest de l'embouchure est dû à la crue du Rhône du 7 juin 1985 ($620 \text{ m}^3/\text{s}$). Le passage des eaux du Rhône à 200 m de profondeur s'exprime par une augmentation du courant et de la température entre 10h30 et 16h00.

Bild 13. Aufzeichnung eines zuflussbedingten Dichtestroms im Rhonedelta des Genfersees infolge des Hochwassers vom 7. Juni 1985 ($620 \text{ m}^3/\text{s}$). Messposition: 5 km westlich der Rhonemündung in 200 m Tiefe. Der Dichtestrom zeichnet sich zwischen 10.30 und 16.00 Uhr durch hohe Strömungsgeschwindigkeiten und erhöhte Temperatur aus.

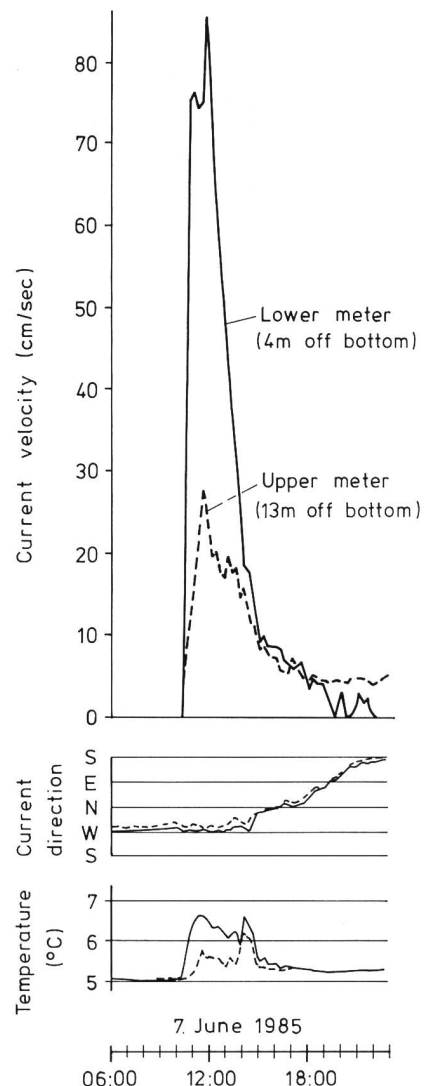

one being characterized by distinct temperature anomalies up to several degrees, the second one yielding only insignificant anomalies of 0.1°C or less. Whereas the first type is attributed to the intrusion of sediment-laden warm river water into the cold bottom water of the lake as a dense turbidity underflow, the second type could be due to turbidity currents triggered by sliding or slumping of more or less important delta deposits; the entrainment of relatively cold lake water by such avalanche-induced turbidity currents would thus explain the faint temperature anomalies. Ongoing studies aim to evaluate the impact of density current activity on overall lake water quality.

Dr. André Lambert

Modelling the regional heat budget in aquifers

During the last decades an increasing number of heat pumps have been installed in aquifers. They use the relatively warm groundwater as a natural energy resource. Through a well the water is extracted to a heat exchanger. After cooling it, the cold water has to be reinjected into the aquifer. The extracted energy is renewed mainly by atmospheric heat input, infiltrations of river water and precipitation during the warmer seasons. As the same aquifers are used as drinking water resources, it is important to prevent overuse of the groundwater in terms of energy, water quality and quantity.

For the management of the groundwater an adequate model is needed. This model should allow the simulation of the prevailing physical processes that determine the flow of water and energy in the aquifer. In shallow aquifers the water flows horizontally. The energy is advected and dispersed by the flow. On the other hand the energy exchange between atmosphere and groundwater occurs through the confining unsaturated layer, and the predominant process is in the vertical direction. Thus the whole physical system is fully three-dimensional with a nonlinear coupling of hydrodynamic and thermodynamic equations.

To circumvent a three-dimensional treatment of regional aquifer problems, an interlaced numerical model based on the finite element technique was developed. The vertical and the horizontal directions are separated and discretized with one-dimensional and two-dimensional submodels. For the heat flux from the atmosphere through the confining layer and through the aquifer one-dimensional vertical models are used. The flow and the advection of the energy in the aquifer are calculated with the well-established concept of two-dimensional horizontal models where the unknowns are vertically integrated with the help of some simplifying assumption, as the Dupuit assumption in flow calculations.

As the seasonal influence has to be considered, the model is nonstationary, with a timestepping scheme. The timesteps may be in the order of one or several days. Each timestep may have different boundary conditions. For each timestep the one-dimensional models – one for each node of the horizontal model – are calculated first. They extend in three sections from the ground surface through the confining layer, through the aquifer, and to a certain depth below the aquifer. Each section contains enough quadratic finite elements so that the varying temperature field can be modelled. The horizontal model is a finite element model with isoparametric two-dimensional elements. With this model the flow of the groundwater is calculated. Then for each nodal point the mean value of the groundwater temperature is determined with the values of the corresponding vertical model. Finally the horizontal energy equation is solved and the new temperatures are reintroduced in the one-dimensional models, with the same shape of the temperature curves but with corrected values (*figure 14*). This concept of interlaced models is a good instrument for regional planning of aquifer resources. Water and energy resources can be studied simultaneously and for further demands upper limits can be fixed.

Dr. Jürg Trösch

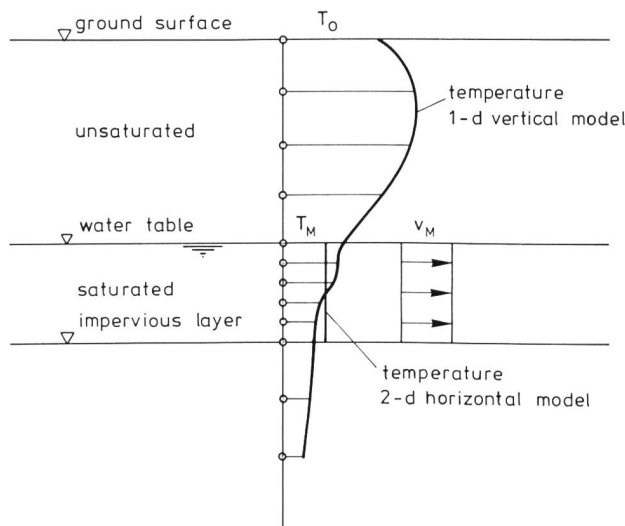

Figure 14. View of cross section with one-dimensional vertical and two-dimensional horizontal models for groundwater heat studies.

Figure 14. Vue du modèle unidimensionnel vertical et du modèle bidimensionnel horizontal pour l'étude des ressources en énergie des nappes souterraines.

Bild 14. Schnitt mit vertikal eindimensionalem und horizontal zweidimensionalem Modell zur Berechnung des Wärmehaushaltes von Grundwassersträgern.